



# Viz Multiplay User Guide

Version 3.1





**Copyright** ©2023Vizrt. All rights reserved.

No part of this software, documentation or publication may be reproduced, transcribed, stored in a retrieval system, translated into any language, computer language, or transmitted in any form or by any means, electronically, mechanically, magnetically, optically, chemically, photocopied, manually, or otherwise, without prior written permission from Vizrt.

Vizrt specifically retains title to all Vizrt software. This software is supplied under a license agreement and may only be installed, used or copied in accordance to that agreement.

### **Disclaimer**

Vizrt provides this publication “as is” without warranty of any kind, either expressed or implied. his publication may contain technical inaccuracies or typographical errors. While every precaution has been taken in the preparation of this document to ensure that it contains accurate and up-to-date information, the publisher and author assume no responsibility for errors or omissions. Nor is any liability assumed for damages resulting from the use of the information contained in this document. Vizrt’s policy is one of continual development, so the content of this document is periodically subject to be modified without notice. These changes will be incorporated in new editions of the publication. Vizrt may make improvements and/or changes in the product(s) and/or the program(s) described in this publication at any time.

Vizrt may have patents or pending patent applications covering subject matters in this document. The furnishing of this document does not give you any license to these patents.

### **Antivirus**

Vizrt does not recommend or test antivirus systems in combination with Vizrt products, as the use of such systems can potentially lead to performance losses. The decision for the use of antivirus software and thus the risk of impairments of the system is solely at the customer's own risk.

There are general best-practice solutions, these include setting the antivirus software to not scan the systems during operating hours and that the Vizrt components, as well as drives on which clips and data are stored, are excluded from their scans (as previously stated, these measures cannot be guaranteed).

### **Technical Support**

For technical support and the latest news of upgrades, documentation, and related products, visit the Vizrt web site at [www.vizrt.com](http://www.vizrt.com).

### **Created on**

2023/07/20

# Contents

<b>1</b>	<b>Introduction.....</b>	<b>8</b>
1.1	System Overview.....	9
1.2	Related Documents.....	9
1.3	Feedback.....	10
1.4	Support.....	10
<b>2</b>	<b>Installation and Configuration.....</b>	<b>11</b>
2.1	Prerequisites.....	11
2.2	Installation.....	11
2.3	Connecting to Different Media Sequencers.....	11
2.4	HTTPS and Authentication.....	12
2.4.1	Authentication.....	12
2.5	Video Wall Configuration.....	13
2.5.1	Video Wall Setup.....	13
2.5.2	Screen Sizes and Resolutions.....	16
2.5.3	External Preview.....	16
2.5.4	Using Datapath Fx4.....	17
2.5.5	Working with Superchannels.....	23
2.5.6	Working with GFX Channels.....	32
2.6	Settings.....	34
2.6.1	Color Correction.....	35
2.6.2	General.....	40
2.6.3	Inboxes.....	43
2.6.4	MOS Configuration.....	44
2.6.5	Pilot DB Config.....	46
2.6.6	Profiles.....	46
2.6.7	Servers.....	50
2.6.8	Workspaces.....	52
<b>3</b>	<b>The User Interface.....</b>	<b>55</b>
3.1	Overview.....	55
3.2	Keyboard Shortcuts.....	56
3.2.1	Main Window.....	56
3.2.2	Profile Configuration.....	58
3.2.3	Video Editor.....	58

3.2.4	Workspaces .....	59
3.2.5	Video Wall Designer .....	59
3.3	Status and Logs .....	60
3.3.1	Status Bar .....	60
3.3.2	Logs .....	60
3.3.3	Version Information .....	61
3.4	Toolbar and Channels Layout.....	61
3.4.1	Toolbar.....	61
3.4.2	Resizing and Collapsing Channels.....	62
<b>4</b>	<b>Workflows.....</b>	<b>65</b>
4.1	Roles in Viz Multiplay.....	66
4.1.1	The Journalist .....	66
4.1.2	The Control Room Operator .....	66
4.1.3	The Presenter .....	66
4.2	Designing Video Walls .....	66
4.2.1	Superchannels-based Video Walls.....	67
4.2.2	Dynamic Channel-based Video Walls .....	67
4.2.3	Video Wall Designer Layout.....	68
4.2.4	Channel Bin .....	70
4.2.5	Presets Bin .....	70
4.2.6	Channel Details .....	71
4.2.7	Channel Layout Editor.....	72
4.2.8	Active Areas Editor.....	75
4.3	Importing Graphics .....	77
4.3.1	Three Ways of Accessing Graphics in Viz Multiplay.....	78
4.3.2	Basic Scene Import.....	78
4.4	Setting Up and Organizing Content.....	81
4.4.1	Using Custom Thumbnails for Media Elements.....	82
4.4.2	Setting Up a Preview Server .....	82
4.4.3	Working With Shows and Profiles .....	84
4.4.4	Shortcuts .....	86
4.4.5	Working with Graphics .....	87
4.4.6	Inboxes .....	88
4.4.7	Working with Images and Videos .....	89
4.4.8	Edit Graphics, Videos and Images .....	91
4.5	Preparing and Playing Out Content .....	94
4.5.1	Preparing Content.....	94

4.5.2	Cleaning and Clearing the Renderers .....	97
4.5.3	Arming .....	98
4.5.4	Playing Out Content .....	98
4.5.5	Swapping Content between Armed and Program .....	99
4.5.6	Auto-playlist .....	100
4.6	Working with Filled Presets .....	102
4.6.1	For Dynamic Walls, Presets with GFX Channels are: .....	102
4.6.2	For Video Walls with Superchannels, Presets are: .....	102
4.6.3	Common Workflow .....	103
4.6.4	Adapt the GUI for Pre-filled Walls .....	104
4.6.5	The Preset Content Editor .....	105
4.7	Working with Viz Pilot and MOS Rundowns .....	106
4.7.1	Working with Playlists .....	107
4.7.2	The Newsroom Workflow .....	107
4.7.3	Pilot Data Server .....	110
4.8	Using a Switcher .....	113
4.8.1	Background .....	113
4.8.2	Workflow .....	114
4.8.3	Configuring the Media Sequencer .....	114
4.8.4	Learning Elements .....	115
4.8.5	Recalling and Triggering .....	117
4.9	Using Graphic Hub Image Staging .....	118
4.9.1	Required Components .....	118
4.9.2	Configuration and Setup .....	119
4.9.3	Workflow in Viz Multiplay .....	119
4.10	Finding Media and Content in Sources Pane .....	121
4.10.1	Media Tab .....	121
4.10.2	Inbox Tab .....	126
4.10.3	GFX Tab .....	127
4.10.4	Video Walls Tab .....	128
4.10.5	Dynamic Walls Tab .....	130
4.10.6	Templates Tab .....	131
4.11	Editing Graphics, Videos and Images .....	137
4.11.1	Editing Images .....	138
4.11.2	Editing Videos .....	139
4.11.3	Editing Graphics .....	141
4.12	Arming and Taking Elements .....	147

4.12.1	Media Pane .....	147
4.12.2	Armed .....	151
4.12.3	Program.....	152
4.12.4	Arm and Take Multiple Elements.....	155
4.12.5	Reload Scene .....	155
4.13	Organizing Shows and Playlists .....	156
4.13.1	Browse Shows Window .....	157
4.13.2	Show Pane .....	158
4.13.3	Locating Page Lists, Playlists and Groups .....	158
4.13.4	Add, Delete or Rename a Group.....	159
4.13.5	Move Groups to Other Playlists in the Show Pane .....	160
4.13.6	Add a New Playlist .....	161
4.13.7	Working with Playlists .....	162
4.14	Using the Shortcuts Bar.....	164
4.14.1	Elements in the Shortcuts Bar.....	164
4.14.2	Layers.....	168
4.14.3	Working with the Shortcuts Bar .....	168
4.14.4	Reveal Extra Information on Thumbnails .....	169
5	<b>Appendix.....</b>	<b>170</b>
5.1	FAQs.....	170
5.1.1	What is the Technical Limitation of Playing HD Clips? .....	170
5.1.2	Does the Playlist Update after Changes in the Newsroom System Rundown? .....	170
5.1.3	Can Viz Multiplay Payout Graphics Created via Viz Pilot Templates? .....	171
5.1.4	Can Viz Multiplay Open a Playlist from Viz Pilot?.....	171
5.1.5	Can Viz Multiplay Open a MOS Rundown? What is the workflow? .....	171
5.1.6	Can We Have Live Input in One of the Monitors or Across a Group? .....	171
5.1.7	Can Viz Multiplay be Controlled by Viz Mosart, VDCP, Viz Trio or Viz Pilot?.....	171
5.1.8	Can Viz Multiplay be integrated into a Viz Mosart Workflow?.....	171
5.1.9	Do I need a Viz One to Feed Viz Multiplay with Clips and Images?.....	171
5.1.10	Does Viz Multiplay Support Stream Deck? .....	172
5.2	Glossary .....	172
5.3	Troubleshooting .....	172
5.3.1	The Viz Engine Output Keeps Going Black Randomly.....	173
5.3.2	When I Run Viz Engine in Fullscreen My Graphic Quality Downgrades to SD.....	173
5.3.3	Video Transfer from a Search Result to a GFX Channel Stays on 0% .....	173
5.3.4	Video Transfer from a Search Result Gives Errors .....	173
5.3.5	The Search Panel Looks Disabled and It Returns an Error about Viz One.....	173

- 5.3.6 My Clips/Graphics do not Appear on the Output Engines when I Put Them On Air..... 174
- 5.3.7 No Thumbnails for My Graphics Appear in Viz Multiplay ..... 174
- 5.3.8 The Show Opens but Doesn't Display Any Stories or Content ..... 174
- 5.3.9 I Have Set up Profiles but Get an Error about No Viz/Video Program ..... 174
- 5.3.10 Problems Running Preview Server..... 174
- 5.3.11 Viz Multiplay Limitations..... 174

---

# 1 Introduction

Viz Multiplay is a powerful tool for controlling studio screen content. The simple interface can be used in the control room or by the presenter in the studio.

- Send content quickly to multiple screens.
- Dynamic control from a single interface.
- Control live, video, graphics and still images.
- Build playlists and full content editing.
- Browser based, so it can run on any computer or a tablet, with an easy-to-use interface.





## 1.1 System Overview

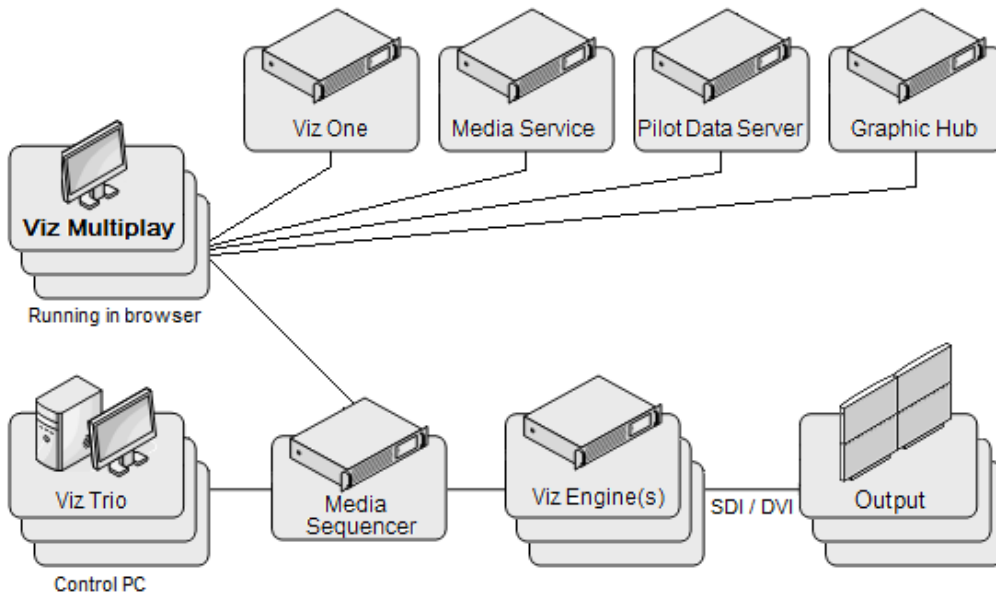

- Viz Multiplay is compatible with graphics from Viz Trio and Viz Pilot. Shows from Viz Trio are available in Viz Multiplay.
- You are able to access and use templates and elements from Pilot Data Server.
- Is hosted on a URL on Media Sequencer. Any number of clients can connect to the same Media Sequencer, which provides the scheduling for playout.
- Uses Viz Engine for playout:
  - The video wall feature allows up to four DisplayPort outputs with UHD resolution from a single GPU in a Viz Engine. With Datapath Fx4 display controllers, the number of outputs can be increased to match numerous screens and panels of different shapes and orientations.
  - Also supports Standard SDI-based playout.
- Can access media assets stored in Viz One.
- Can open and control newsroom playlists in a MOS workflow.

## 1.2 Related Documents

See the [Vizrt Documentation Center](#) for our related products documentation, including:

- Viz One
- Pilot Data Server
- Graphic Hub
- Viz Trio
- Media Sequencer
- Viz Engine

For more information about all Vizrt products, visit:

- [www.vizrt.com](http://www.vizrt.com)
  - [Vizrt Documentation Center](#)
  - [Vizrt Training Center](#)
  - [Vizrt Forum](#)
- 

## 1.3 Feedback

We welcome your feedback and suggestions regarding Vizrt products and this documentation. Please contact your local Vizrt customer support team at <http://www.vizrt.com>.

---

## 1.4 Support

Support is available at the [Vizrt Support Portal](#).

---

## 2 Installation And Configuration

---

### 2.1 Prerequisites

- Media Sequencer must be installed on the computer hosting Viz Multiplay.
  - A Viz Multiplay-licensed Media Sequencer is required on the server machine. If there is no valid license on the server machine, a warning message appears, which is shown every 20 minutes.
  - Media Sequencer must be running before installation, since Media Sequencer acts as a web server for Viz Multiplay.
  - Check the Video Wall Configuration section in the [Viz Engine manual](#) to ensure that your setup is working properly. See the Release Notes for more on components and versions.
- 

### 2.2 Installation

- Run the installer on the computer running Media Sequencer. The installer looks for the Media Sequencer file location and adds Viz Multiplay to the *www/app* folder, making it accessible from this URL: <http://localhost:8580/app/vizmultiplay/vizmultiplay.html>.
  - The installer also places a shortcut to the Desktop, with the above mentioned URL. If Viz Multiplay should be accessed on a different host or port, this shortcut must be updated with the correct target (for example, for secure configuration: [https://\[mse-host\]:8543/app/vizmultiplay/vizmultiplay.html](https://[mse-host]:8543/app/vizmultiplay/vizmultiplay.html)).
  - To use the video wall feature, a Viz archive called *multiplay\_scenes.via* is distributed with the installer. This must be imported into a Graphic Hub to be available for the Viz Engine during playout. This archive contains the DynamicChannels and StillAndVideo scene, and Superchannel\_still scene.
  - The default installation location is: `<MEDIA_SEQUENCER_URL>\www\app\vizmultiplay`. For example: `%ProgramFiles%\Vizrt\Media Sequencer\www\app\vizmultiplay`.
  - The default location is recommended, but can be configured if required.
- 

### 2.3 Connecting To Different Media Sequencers

Media sequencer stores all playlists and shows and makes them available to all control applications connected to it. Viz Multiplay and other control clients (such as Viz Trio) must be connected to the same Media Sequencer (MSE) in order to share a show. Viz Multiplay can be hosted on one Media Sequencer and connected to another Media Sequencer by adding the URL parameter `mse=<host>` to the URL:

```
<ms_host>:8580/app/vizmultiplay/vizmultiplay.html?mse=<mse_hostname>
```

This section covers the following topics:

- [HTTPS and Authentication](#)
- [Video Wall Configuration](#)
- [Settings](#)

## 2.4 HTTPS And Authentication

From Media Sequencer 5.5 it is possible to configure it to use a secure communication over HTTPS when communicating with clients, including Viz Multiplay. If Media Sequencer is configured to use HTTPS, Viz Multiplay will be accessible on this URL:

<https://mse-host:8543/app/vizmultiplay/vizmultiplay.html>

All URLs in the Servers tab must also use the HTTPS protocol when communicating. The default URL's for the HTTP and HTTPS variants are:

Service	HTTP	HTTPS
Preview Server	<a href="http://ps-host:21098">http://ps-host:21098</a>	<a href="https://ps-host:4443">https://ps-host:4443</a>
Viz One	<a href="http://vizione-host:80/thirdparty">http://vizione-host:80/thirdparty</a>	<a href="https://vizione-host:443/thirdparty">https://vizione-host:443/thirdparty</a>
Pilot Data Server	<a href="http://pds-host:8177">http://pds-host:8177</a>	<a href="https://pds-host:7373">https://pds-host:7373</a> (PDS has no default HTTPS port, but 7373 is a commonly used port.)
Media Service	<a href="http://ms-host:21099/api/service">http://ms-host:21099/api/service</a>	<a href="https://ms-host:21443/api/service">https://ms-host:21443/api/service</a>
Graphic Hub	<a href="http://gh-rest-host:19398">http://gh-rest-host:19398</a>	<a href="https://gh-rest-host:19398">https://gh-rest-host:19398</a>

**Note:** If Media Sequencer is configured with HTTPS, the ImEx Staging application will be opened through the HTTPS protocol. The ImEx Staging Configuration application does not support HTTPS, which means that the HTTP address of the config app must be manually used in the browser: <http://mse-host:8580/app/stagingconfig/stagingconfig.html>.

### 2.4.1 Authentication

When Viz Multiplay is connecting to the various services over HTTP or HTTPS, some of them may require you to authenticate with credentials. Viz Multiplay is not handling this explicitly, but delegates to the web browser to authenticate. This means that a browser popup (outside Viz Multiplay's control) will pop up whenever the browser needs credentials to contact the servers.

Unfortunately Viz Multiplay has little control over the text in these native browser popups, so you need to identify the server asking for credentials by looking at the host name or port, for instance for Graphic Hub, this service is usually running on port 19398:

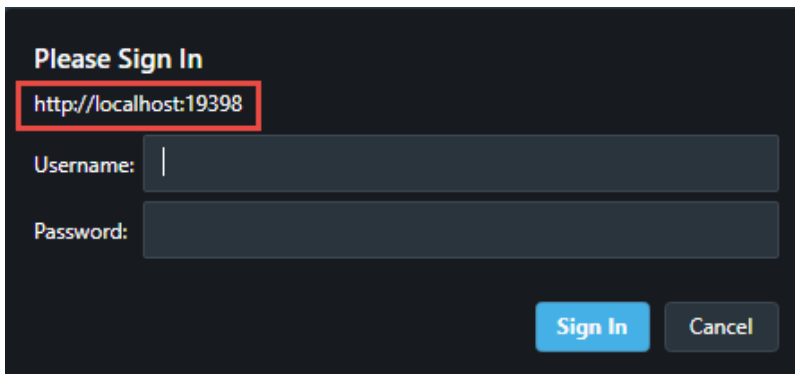

## 2.5 Video Wall Configuration

This section covers creating a profile and setting up and configuring video walls that represent the physical screen setup at the location. Using a separate Viz Engine as an external preview for the video wall is also covered.

A profile can conceptually be seen as a studio, or a physical location where you want to control content on a set of screens. The profile can have one or more video walls that can be controlled individually.

This section covers the following topics:

- [Video Wall Setup](#)
- [Screen Sizes and Resolutions](#)
- [External Preview](#)
- [Using Datapath Fx4](#)
- [Working with Superchannels](#)
- [Working with GFX Channels](#)

### 2.5.1 Video Wall Setup

This section covers how to get started setting up a video wall without using an external video wall display controller. If you use one or more display controllers, for instance Datapath Fx4.

This section covers the following topics:

- [Dynamic Channels and Superchannels](#)
  - [Should I Use Dynamic Channels or Superchannels?](#)
  - [Set up a Profile and Video Wall](#)

**⚠ Note:** As with most changes that effect the Profile, adding, removing or editing a Video Wall should be performed on an inactive Profile. If you edit an active Profile, a deactivation and activation may be required afterwards.

## Dynamic Channels and Superchannels

Viz Multiplay supports two video wall mechanisms:

- The **Dynamic Channels** solution based on a global Viz Multiplay specific Viz Artist scene containing GFX channels.
- The **Superchannels** solution based on Superchannels where each video wall is represented in a user-designed Viz Artist scene (for Viz Multiplay 3.0 and above). See the release notes for the required version of Viz Engine.

## Should I Use Dynamic Channels or Superchannels?

### New Installations

Select the **Superchannels** mechanism. This will allow:

- Better performance
- Arm and fire (or A/B) workflow with content transitions
- Custom transitions between presets (layouts)

### Existing Installations

If you need to support an existing workflow that contains more than eight video wall regions (GFX channels), or if you need quick, offline creation of presets in the video wall designer - stay with the Dynamic Channels solution.

## Set up a Profile and Video Wall

To get started, you will need a profile. A profile is a collection of playout resources. One profile may contain references to one or more physical video walls.

1. Click **Settings > Profiles**.
2. Create a profile by clicking the **Add (+)** button in the bottom of the Profiles list.
3. Enter a name for the new profile.
4. Select whether you want to create a Dynamic Channels wall or a Superchannels wall and click the **Add (+)** in the bottom of the list.
5. Enter a name for the video wall, and **hostname** of the Viz Engine driving the video wall (The Viz Engine must be in On Air mode and reachable through the network when creating a new video wall) how many virtual channels (video wall areas) you need to use.

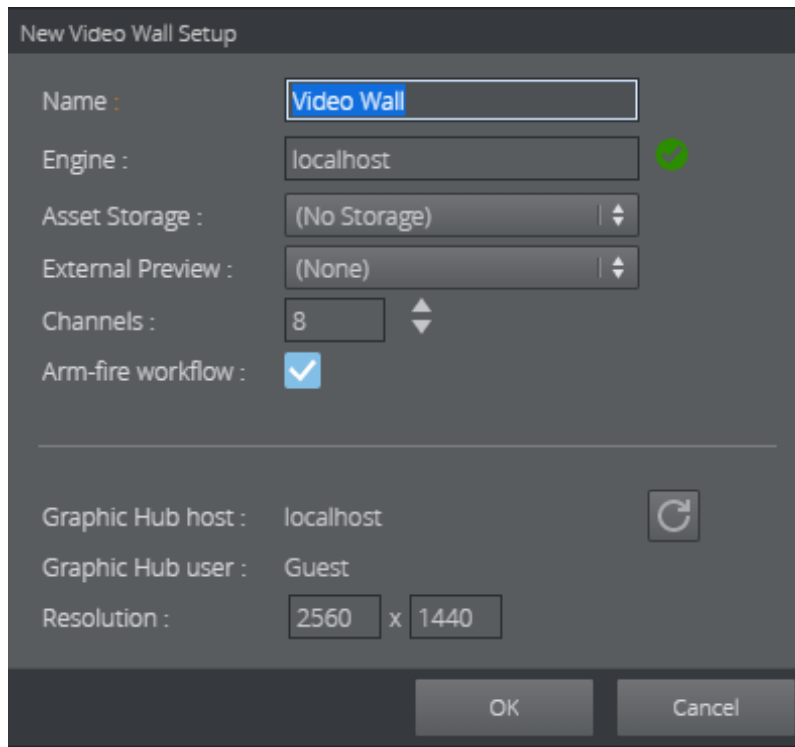

6. If Viz One is configured, select the publishing point to where Viz One will transfer clips when dragged into a playlist in Viz Multiplay. The publishing point is the clip root of Viz Engine, making sure that clips needed for playout are available on the physical Viz Engine hardware.
7. If a separate Viz Engine is used as video wall preview, select the preview video wall in **External Preview**. Everything that is Armed in Viz Multiplay will be taken first to the external preview engine. The preview engine can have any resolution, but it need to have the same aspect as the program engine.

**⚠ Note:** Viz Engine supports up to 16 GFX channels and eight Superchannels. Do not enable more than you need. The number of channels does not need to match the total number of screens you have. Channels are virtual areas that can span over several screens.

8. Enable or disable **Arm and Fire workflow**. This checkbox is only available if both Viz Engine and Media Sequencer support the feature.

In the bottom half of the window, the following information is shown, based on what Viz Multiplay reads out from the connected Viz Engine:

- The Graphic Hub host name and user name of Viz Engine.
- The resolution of Viz Engine.

The Graphic Hub info should match the global Graphic Hub settings in **Settings > Servers**. The resolution can be manually adjusted, or refreshed with the Refresh button. The resolution is used by Viz Multiplay to draw thumbnails and to display correct aspect of the wall and of the channels in the Video Wall Designer.

## 2.5.2 Screen Sizes and Resolutions

### Nvidia Mosaic Limitations

The Nvidia Mosaic setup only supports output to an X \* Y matrix of screens with similar resolution. Nvidia also recommends that all the screens in a Mosaic video wall should be the same model. One GPU can provide four outputs. It is not recommended to add more GPUs to the computer.

### Using Datapath

The easiest way to configure for different screens is to use an external video wall display controller like Datapath Fx4. These controllers accept up to 4K input and 4 outputs. With Nvidia Mosaic up to 4 outputs from the GPU can be combined and split up with Datapath Fx4 display controllers.

#### See

- [Using a Datapath Fx4 Display Controller](#)

## 2.5.3 External Preview

Although the [Armed](#) column provides an indication of content that's ready to be played out, it's not an accurate preview. For an accurate Viz Engine preview of the content, you must configure preview on an external Viz Engine.

**Note:** Depending on how much hardware you have available, the preview can be a simple VGA version of the Viz Engine (without clip playback), or a Video Engine with Matrox hardware for live input and clip playback.

Keep the following in mind:

- The Program and Preview engines can have different resolution, but need the same aspect.
- You can preview live sources if your preview engine is a video-enabled Viz Engine with a Matrox video card. The SDI in signals must then be split to go into both the video wall and the preview engine.
- Although mainly used for testing since its local preview function (reading pages) and the video wall preview will conflict, Viz Trio's local Viz preview can also be used as an external preview. The engines should have the same aspect.

**Info:** The data model behind the Viz Multiplay representation of the channels in the presets (the virtual areas of the video wall) used to communicate with Viz Engine is based on percent, even if the units in the GUI is pixels. This means that presets are compatible between a preview wall and a program wall with different resolutions. It also means that presets from one wall can be used on another video wall, as long as the aspect is the same.



## Setting Up and Using External Preview

To set up a video wall system with Program and Preview engines, two video walls need to be created in the Profile. First you need to create the preview wall:

1. Start the preview Viz Engine engine, configure the resolution and set it in On Air mode.
2. Click **Settings > Profiles**
3. Click on a profile and create a new video wall inside it.
4. This video wall will represent the preview wall.
5. Click **OK** to generate the channels for the preview wall.

**Note:** These channels will not be visible in the main playback GUI in Viz Multiplay.

6. Repeat the process for the Program Video Wall. Remember to start it and set it in On Air mode.
7. When creating the program video wall in the Profile - select your newly created preview wall in the **External Preview** combo box.

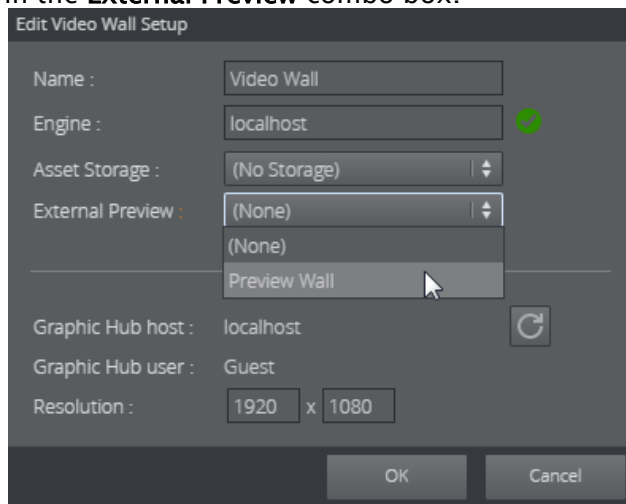

8. Click **OK**. Now, whenever you arm presets and elements (with 1-TAP mode disabled), these elements will be played out on the preview engine. The preview engine then acts as a “real” preview for the main wall, depending on what kind of hardware you use as a preview wall.
9. Go to **Settings > General**. Set the **Extra Armed button** to **CONTINUE**:

Extra Armed button : CONTINUE (preview ...)

This makes an extra button appear in the **Armed** column. Whenever an element is armed, it is taken on the preview engine. Clicking **CONTINUE** now continues the element on the preview engine. In this way, you can preview a full sequence of stop points in a graphics on the preview engine before it is taken On Air in the program engine.

### 2.5.4 Using Datapath Fx4

When considering how to distribute the pixels from the Viz Engine output renderer to physical devices, there are numerous solutions. The two main solutions are using nVidia Mosaic and using the Datapath Fx4 MultiDisplay Controller. This section describes the usage of the Datapath device.

Viz Multiplay integrates with the [Datapath Fx4 MultiDisplay Controller](#):



In principle, Viz Engine draws its output on a renderer surface with a resolution covering the complete output surface. From the renderer surface, it is possible to grab pixel areas and distribute them through one or more Datapath devices to physical outputs (screens). The first step of the configuration is to set up the physical mapping from the input signal to the physical screens. This is done with the software provided by Datapath. When this is done, the Datapath configuration file can be imported into Viz Multiplay and act as a backdrop when creating presets (video wall layouts).

A typical setup covers the following:

- [Connecting the Devices](#)
- [Calculating Resolution](#)
- [Setting Up the Video Wall in Viz Multiplay](#)

**Info:** The details of the Datapath setup will not be covered here. Please see the Datapath Fx4 manual.

## Connecting the Devices

The Datapath Fx4 device accepts up to 4K input through DisplayPort. There are different ways of utilizing one or more Datapath devices together with a Viz Engine. It is recommended to have one GPU from nVidia Quadro series, these cards typically have 4 outputs. If the video wall needs more than a 4K resolution, two or more of the outputs from the GPU can be combined with nVidia Mosaic to create for instance an 8K surface. It is also possible to use Loop Through on the Datapath device to distribute the original signal unchanged to other outputs.

The Datapath devices can scale, duplicate or rotate any part of the input surface, so the output wall can have any aspect and resolutions. Rotation is only supported by 90 degrees.

**Note:** Larger resolutions demand more powerful hardware. Be aware of what kind of content, which formats, how many clip and live channels, and the complexity of the graphics the Viz Engine should handle when scaling the wall to large resolutions.

In our typical setup, we connected two outputs from the GPU to each of the two Datapath devices through DisplayPort. We then connected 4 HD screens to each of the Datapath boxes. To control and configure the Datapath devices, we connected the boxes with USB to a separate PC on the network. We installed the Datapath Wall Designer software on this PC. This is the setup:

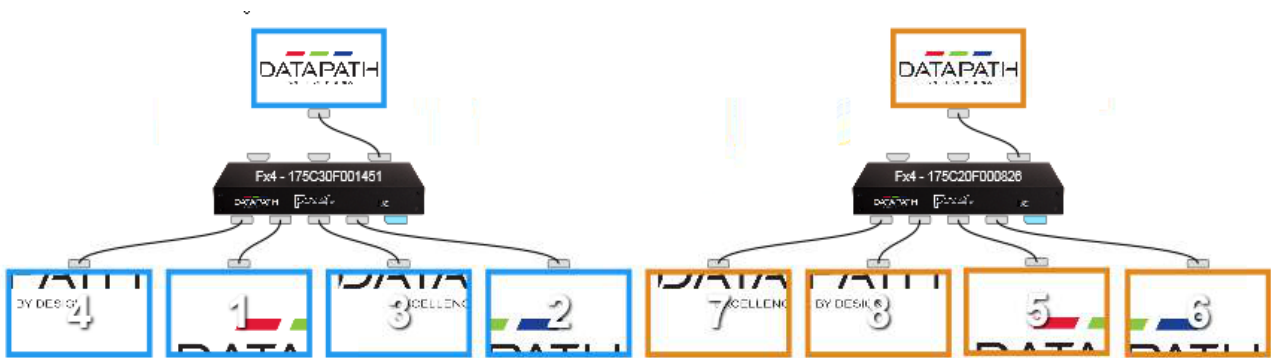

In this setup we use two 4K inputs from the GPU and distribute them to eight screens.

An alternative approach would be to settle for less input resolution and distribute one 4K input to the eight screens, using Loop-Through. If the output screens are HD (1920x1080), the HD screens will show scaled-up content from the 4K input. In case this is an acceptable resolution on the output, it will give better performance.

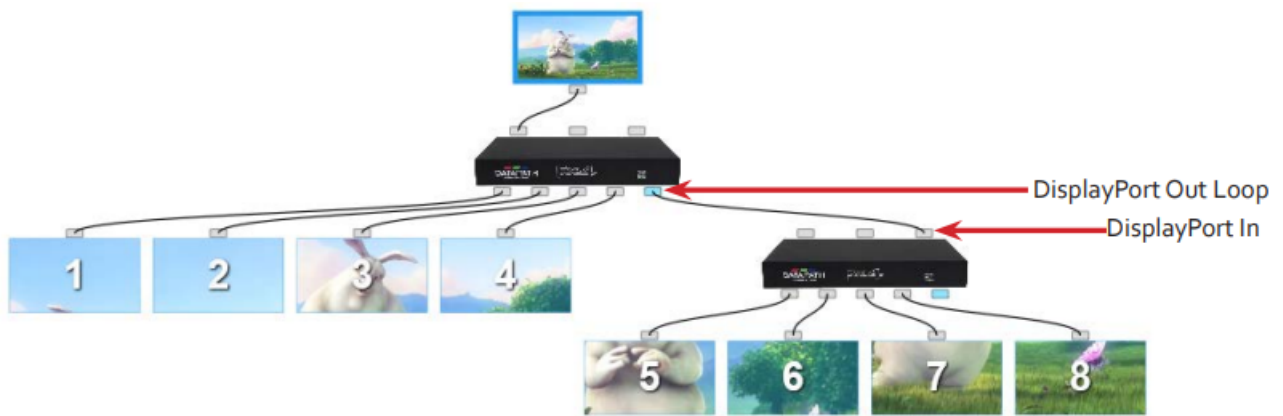

## Using SYNC

To synchronize the output and input devices, it is vital to use a sync signal. The Fx4 must be genlocked to all external devices. Connect the external sync signal to each of the Datapath devices, to the nVidia GPU and the Matrox video card.

## Calculating Resolution

If your wall consists of one large surface without any bezel between screens, the input source resolution in the Datapath configuration can be set to match the wall resolution, given that the total resolution is under 4K (3840x2160). If the resolution of the wall is over 4K, and input resolutions need to be stitched together, each of the input resolutions are summed up to a total resolution, which is the resolution reported through nVidia Mosaic to the Viz Engine. This resolution can be seen in the *Output Format* section in the Viz Engine Configuration.

- ✓ **Tip:** Even though the official limit of the **DisplayPort** input for each Datapath box is **4K/60fps**, the real limitation is the amount of data transmitted over the DisplayPort cable. This is limited by the DisplayPort standard "HBR2" which has a limit of 17.28 Gbit/s. This is enough for 4K/60 with 8bit per color. If the refresh rate is 50, the resolution can be slightly higher than 4K. The bandwidth can also be affected by the cable length. Please see the Datapath manual.

## Bezels

If the screens connected to a Datapath device have a frame around the active area, the distance between the screens should be encountered in the total input resolution. The distance contains invisible pixels that will be drawn by the Viz Engine renderer, but cut away by the Datapath box. There are two ways of taking bezels into account:

1. Set the input resolution to a total of 4K or whatever the Viz Engine should output. Then, to count for the distance disappearing between the screens, calculate how many pixels are left for each screen. Example: Input resolution is 4K (3840x2160), output screens are HD (1920x1080). Now, there aren't enough pixels in the input resolution to fill each screen with full HD and cover the distance between the screens. You need to calculate how many pixels you have per cm in total and reduce the capture area available for the screens. The Datapath box will scale up the content to fill the screens. This method is hard to calculate and get correctly configured.
2. The easier way: Set the input resolution to higher than the total resolution of the screens to cover for the lost pixels. Calculate how many pixels you need to add to the input resolution (horizontal and vertical) to let the screens have their content in full resolution (1920x1080 for instance), and add the amount of pixels needed to cover the gap between the screens.

In our setup, we used method number 2. We found that we had to add about 170x192 pixels to the total resolution to cover for the pixels between the screens. So the total input resolution was 4000x2352. As we run in PAL (50Hz), we still are under the maximum bandwidth of the DisplayPort capacity. This way, the capture regions for each screen is 1920x1080, and they are placed in the corners of the total surface.

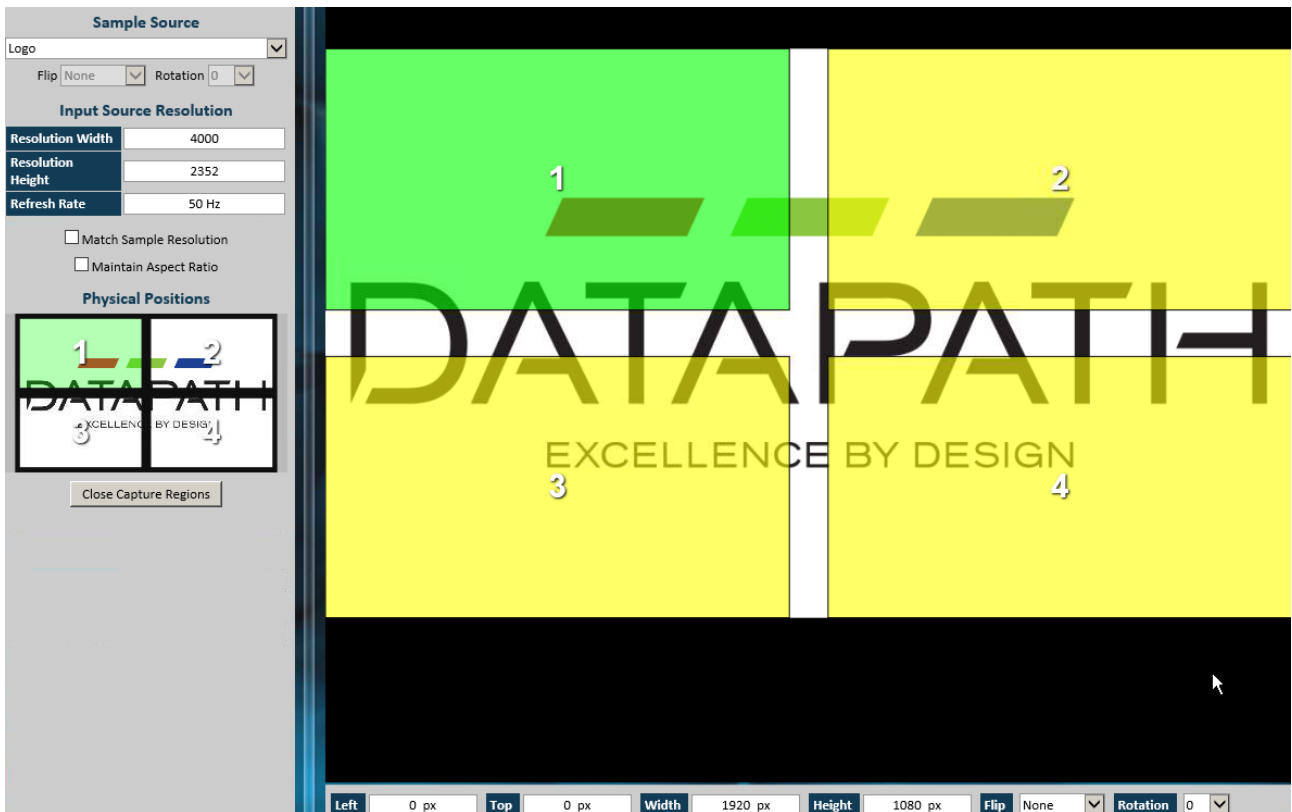

In our setup, two Datapath devices were connected to 4 screens each. The bezel internally between 2x2 screens is taken care of by the Datapath configuration, as shown above. But there is also a gap between the two blocks of 4 screens, which is outside the Datapath areas. This gap (170 pixels) was taken care of in the nVidia Mosaic configuration, the total resolution for the renderer then became 8170x2352.

## Setting Up the Video Wall in Viz Multiplay

In Viz Multiplay, the goal is now to use the Datapath configuration as a backdrop for editing the GFX channel layouts (presets).

### Create the Video Wall

When creating a new video wall in a profile, the physical layout of the wall should be determined by the Datapath configuration, and the total resolution of the Viz Engine renderer needs to be calculated to include potential gaps between physical screens. In our typical setup, 2 x 4K plus bezel between the screens ended up in a resolution of 8170x2352. When a video wall is created, the video wall Viz Engine needs to run and be in On Air mode for Viz Multiplay to read out the resolution of the renderer. Viz Multiplay will now know the dimensions of the total renderer surface and use this as an empty backdrop for the presets in the Video Wall Designer.

### Import the Datapath layout in the Video Wall Designer

In the Video Wall designer, it is possible to create and edit the Active Areas, which will become snap points for the GFX layout (the presets). But since the visual configuration already is done in

the Datapath Wall Designer, we can import this configuration into Viz Multiplay. In Datapath Wall Designer, you need to save the configuration. This becomes a `*.wdl` file, which consists of an XML structure describing the Datapath setup (inputs and capture areas). If you have more than one Datapath box connected to the computer running the Wall Designer, or on the network, the `wdl` file contains the combined configuration.

- In the Video Wall designer, click the Active Areas Editor button:

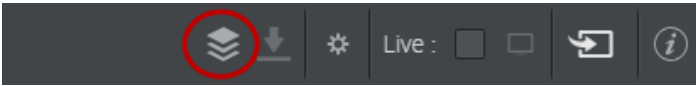

In the Active Areas editor mode, the GFX channels are hidden, and only the backdrop is visible. For now, the backdrop is one, empty area.

- Now you can import the `wdl` file by clicking the Import button:

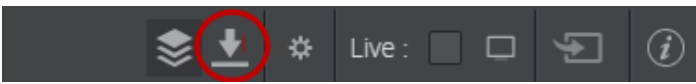

A dialog box then opens. Either click the area in the middle or drag the `wdl` file into this area. The PC where you are running Viz Multiplay needs to have access to this file, either from a shared disk or you can copy the file from the Datapath Wall Designer PC to the Viz Multiplay PC first. When the file is read, a green status message will display the file name and a **Done!** message. Under this message, the number of Datapath wall regions (capture areas) is displayed.

- Click **Add** to generate the Active Areas in the Video Wall designer.

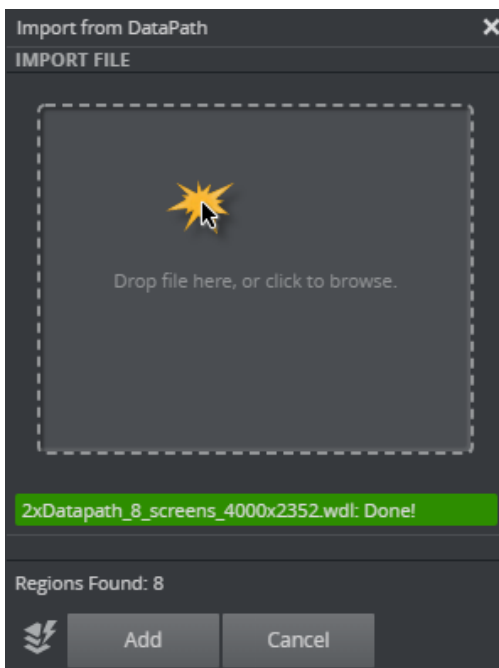

The next time this operation is done, it is possible to clear the existing Active Areas first, by clicking the following toggle button:

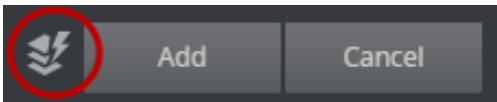

After importing and possibly editing the Active Areas from the Datapath configuration, the Video Wall designer may look like this:

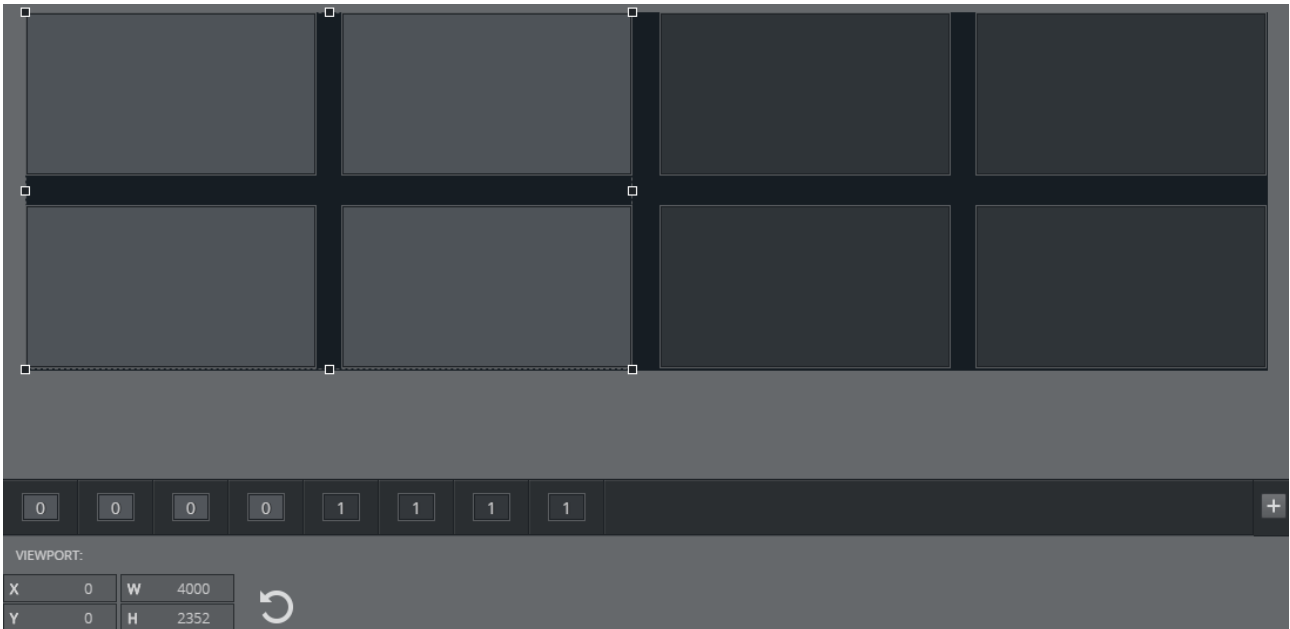

In this case, we have imported 8 regions from 2 Datapath boxes. Each of the Datapath devices is represented as a group of Active Areas. The numbers below the editor (0 and 1) indicate which group each area belongs to.

- Clicking once on an Active Area will select this area individually.
- Clicking the next time will select the group this area belongs to.

✓ **Tip:** When importing a Datapath configuration containing more than one Datapath device, the groups will initially be placed on top of each other in the editor. The Datapath configuration contains no info on where the outputs of the devices are located relative to each other. In our typical setup, both groups of 4 screens ended up on the left side of the editor. The second group then had to be dragged to the right side of the video wall representation in the editor. In this case, it is useful to enable the "Live" function and the "Fill color" function to ensure that the Active Areas actually match the monitors in the video wall.

## 2.5.5 Working with Superchannels

This section covers the following topics:

- [Recommended Workflow](#)
- [Working with Superchannels in Viz Artist](#)
- [Organizing Presets with the Viz Artist Presets Plugin](#)
- [Working with Superchannels in Viz Multiplay](#)

- [Creating a Profile and Adding a Video Wall](#)
- [Working with Superchannel Presets in the Video Wall Designer in Viz Multiplay](#)
- [Using Video Wall Presets in a Show](#)

**Note:** Superchannels in Viz Multiplay require Viz Artist and Engine. See the release notes for more on version requirements.

A *Superchannel* is an abstraction on top of specific media asset channels. Superchannels support different types of media assets: Images, Graphics, Clips, Streams, Live content etc. With Superchannels, content in each channel can be played out in an A/B workflow. Each Superchannel has two sub channels. One sub channel (A) is active, while the second (B) is inactive. New content can be prepared in inactive sub channels, and a transition effect can run the transition from the active to the inactive sub channel, switching their roles.

In a Superchannels-based video wall scene, you can customize transitions between preset positions in the video wall layout, and combine content and preset transitions to create more advanced visual video wall behavior.

**Note:** With Superchannels, each Video Wall design is represented by its own Viz Artist scene, whereas in the DynamicChannels solution, all video walls share one Viz Artist scene in Graphic Hub.

## Recommended Workflow

1. Create a video wall with a default scene in Viz Multiplay, and use Viz Multiplay's [Designing Video Walls](#) to create the basic presets.
2. Switch to Viz Artist for complex manipulation, like adding custom transitions.
3. When switching back to Viz Multiplay, remember to re-import the presets to the show.

**Note:** You can also create a Superchannels-based video wall scene in Viz Artist and import it into Viz Multiplay. The scene must then contain the Viz Artist *Presets* plugin, which organizes the presets in the video wall layout

## Working with Superchannels in Viz Artist

In Viz Artist, find Superchannels in the **Plugins** tab, under **Super**:



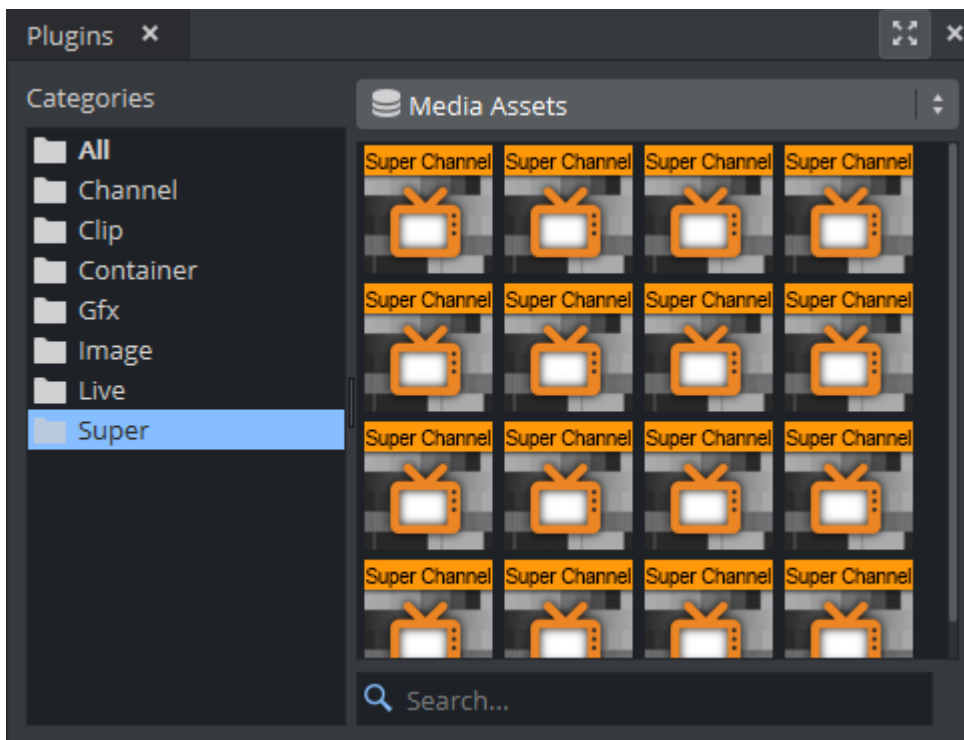

These channels should be added to the scene through the Presets plugin. The layout (size and position) of the Superchannels in the renderer can be organized manually in Viz Artist. A single set of pre-defined Superchannels layouts is called a *preset*. When played out, the scene will arrange the Superchannels in their previously saved (preset) position.

## Organizing Presets with the Viz Artist Presets Plugin

Use the plugin to add and organize more presets in the same scene. To create a video wall scene in Viz Artist:

- Create a new scene.
- Find the Presets under **Plugins > Control > Scene Plugins** and drag it into the **Plugin** section of Scene Settings.
- Go to the Presets plugin GUI under **Scene Settings > Plugin** and add, delete or manipulate presets and transitions between them. Each preset will get a name that is later visible to the Viz Multiplay operator, along with a visual representation of the preset.
- Also use the Presets plugin to **add superchannels** to the scene, as this will auto create content transitions between the sub channels.

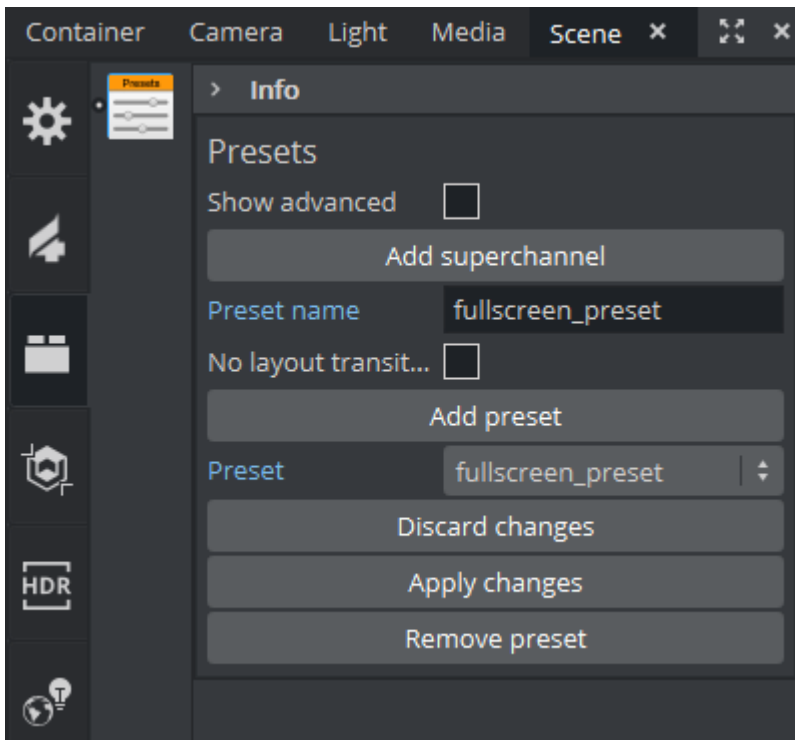

The plugin will automatically generate directors for

- The preset initial position (for a Cut to the preset).
- Transitions to and from all presets (one director per combination, running forwards or backwards).
- Content transitions (crossfade) between content in each Superchannel.

In the following example, two presets called **all-visible** and **full\_screen1** have been added to the scene using the Presets plugin:

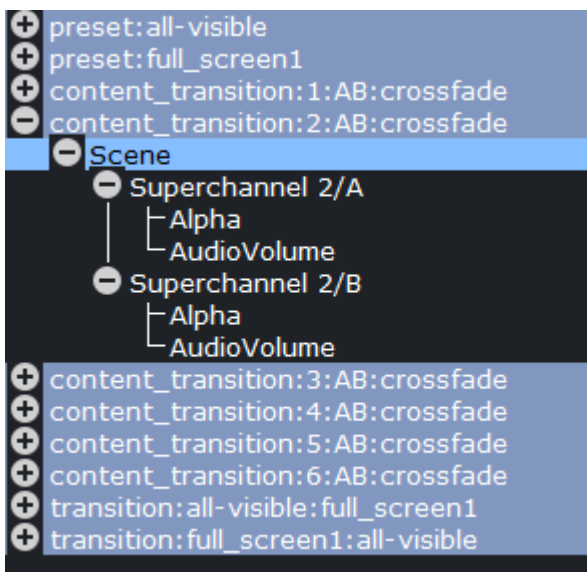

When you are done in Viz Artist, the scene can be saved and imported into Viz Multiplay as a new video wall design.

**Note:** In Viz Multiplay, when you do a Take on a preset, Media Sequencer ensures the director leading from the current preset to the taken preset is run inside the scene. When new content is taken inside a Superchannel in the preset, Media Sequencer ensures the content transition director is run for the Superchannel, switching from the existing content to the new content. This director is run regardless of the old and new media asset type, for example, from clip to image or graphics to live. All content types will get the same transition.

## Working with Superchannels in Viz Multiplay

Create and organize presets with Viz Multiplay. To create a new video wall, create a profile and add a video wall under the **VideoWalls** tab.

### Creating a Profile and Adding a Video Wall

**Note:** The video wall engine must be started and in On Air mode when you create a video wall. Viz Multiplay will read out the Graphic Hub host and user name, along with the current resolution of the wall.

**Note:** This operation only needs to be done once per physical video wall.

- Go to **Settings > Profiles**.
- Create a profile.
- Click the **Plus** button to add a video wall under the Video Walls tab.

New Video Wall Setup

Name : Big Studio Wall

Engine : localhost ✔

Asset Storage : (No Storage) | ▾

External Preview : (None) | ▾

Channels : 4 | ▾

Arm-fire workflow :

---

Graphic Hub host : localhost ↻

Graphic Hub user : Guest

Resolution : 2560 x 1440

OK Cancel

- Specify the host name of the video wall **Engine**.
- Select the publishing point used if you use a Viz One media asset provider. This ensures that clips are transferred from Viz One to the playout engine.
- Select an **External Preview** engine.
- Specify the number of **Channels** you need.
- Enable or disable **Arm and Fire workflow**. This feature is only available if both the Viz Engine and Media Sequencers support it.

When you click **OK**, the following happens:

- Media Sequencer creates viz and video handlers to communicate with the engine specified.
- A new design entry is added to the video wall with the same name as the video wall.
- A new scene is created under **Vizrt/VideoWall/** in Graphic Hub.
- A default preset is created inside the new video wall scene.

You now have a Video Wall in your profile (*Big Studio Wall*), a new scene (*Vizrt/VideoWall/Big\_Studio\_Wall*) in Graphic Hub with a default preset.

You can rename the design to something more descriptive. Although the design is renamed **Morning Show** in the screenshot below, it still points to the same scene in Graphic Hub. You can find the scene name and scene path to the video wall scene by hovering your cursor over the design entry in the Super Walls tab:

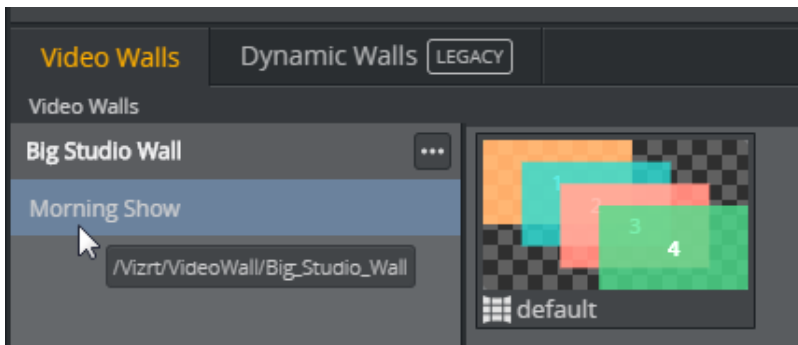

You can add more designs (scenes) to this video wall later - for instance one for a morning show and one for an evening show. To do this, click the 3 dots-button to the right of the video wall and select **Create new scene**. This will add a new scene to the Graphic Hub, belonging to this video wall.

**Info:** To switch designs, play out the corresponding presets from Viz Multiplay. The engine will then play out the new design scene with the wall presets.

New position and size data is sent from Viz Multiplay to Superchannels as a percentage, if you change the resolution or aspect, the presets maintain their same relative dimensions. The best practice is to start the wall engine in the resolution in which it is to be operated in order to ensure that this is correct from the beginning.

**Note:** Resolution and aspect data can be refreshed later if the video wall engine needs to change resolution.

**Note:** Editing, adding or removing a preset requires the Video Wall engine to be on and in On Air mode. This is because the data for a preset now is stored inside a scene, which requires the Viz Engine to save the scene. If the wall engine cannot be disturbed, the best practice is to edit video wall presets on a preview engine *with resolution in the same aspect*, in a different profile.

## Working with Superchannel Presets in the Video Wall Designer in Viz Multiplay

Once a video wall and a scene with a default preset have been created, you can adjust preset positions and add more presets in the Video Wall designer:

- Go to **Settings > Profiles**.
- Click the profile with the video wall engine.
- Click the design entry under a video wall (**Morning Show** in the example below).
- The presets for the scene design are now visible.
- Right click a preset and select **Edit preset**.

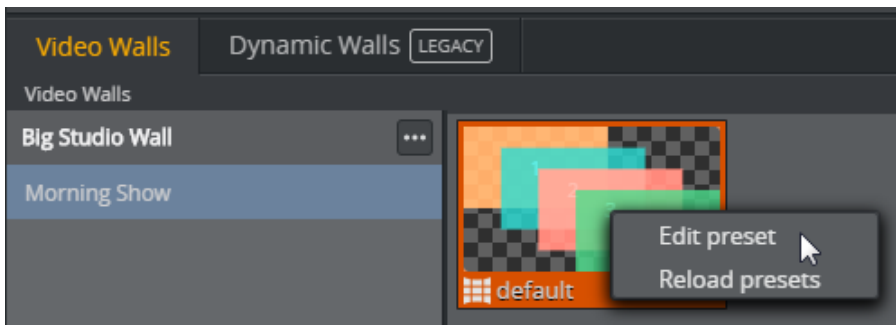

Now the Video Wall Designer opens. Here, you can add, delete, duplicate and edit presets with the [Designing Video Walls](#) tools.

When you click **Save**, the scene and all presets are saved in Graphic Hub through the Viz Engine. This means that the video wall Viz Engine must be started and On Air. When closing the Video Wall Designer, the updated presets for the design are displayed in the video wall manager:



## Using Video Wall Presets in a Show

Superchannel video wall presets are resources belonging to a specific Profile. The Profile contains the video wall description and keeps track of the designs (scenes) for the video wall.

When creating a Show with content, the presets for the Video Wall you want to use in the Show must be imported into the VideoWall tab:

- Click the **Video Walls** tab.
- Click the **plus** button.

- Click the video wall design to import the presets.

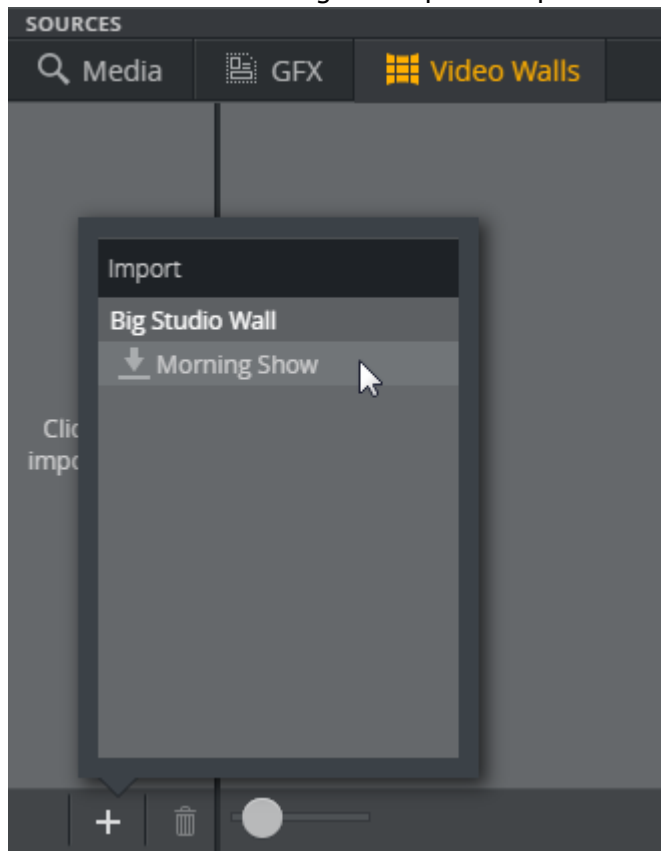

The presets for the video wall design you imported will now appear in the Video Walls tab:

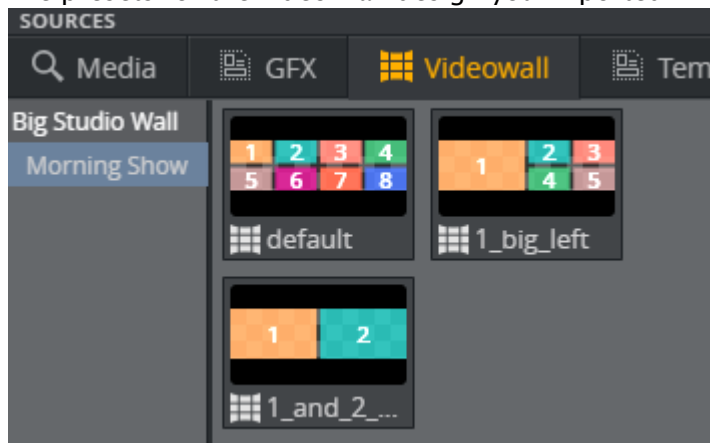

To use the presets, drag them over to the Shortcuts bar.

**Note:** The recommended workflow is to create one Shortcuts tab per video wall design in order to group the presets belonging to each wall.

**Note:** When controlling multiple video walls from the same Show, it's good practice to create one Workspace per video wall - only displaying the channels and Shortcuts groups relevant for the video wall to control.

## 2.5.6 Working with GFX Channels

Multiplay bundles two scenes: **DynamicChannels** and **StillAndVideo**. These scenes ensure that video wall presets are played out and that still images and clips are supported inside the channels. The underlying mechanism is GFX Channels in the Viz Engine. Each GFX channel has one layer where it can host a graphic scene from Viz Artist. The StillAndVideo scene is a placeholder for images and clips. The GFX channels have no transitions between content and no A/B workflow. Only one scene at a time can be hosted in a GFX channel.

**Note:** Superchannels, which contain transitions and an A/B workflow, are supported. Each Superchannel has two sub channels.

### Creating Presets

1. Start by creating a video wall setup in a profile, under **Dynamic Walls**.

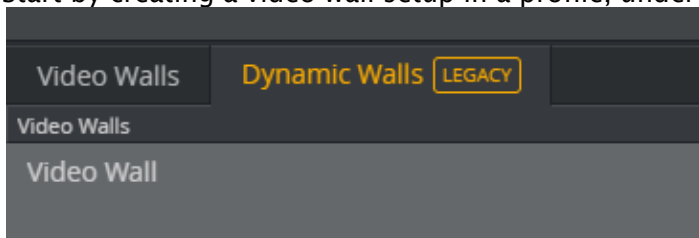

2. Create a show.
3. Activate the profile.
4. When you create a new show, Viz Multiplay automatically creates a separate playlist for presets that is displayed under the **Dynamic Walls** tab in the sources pane:

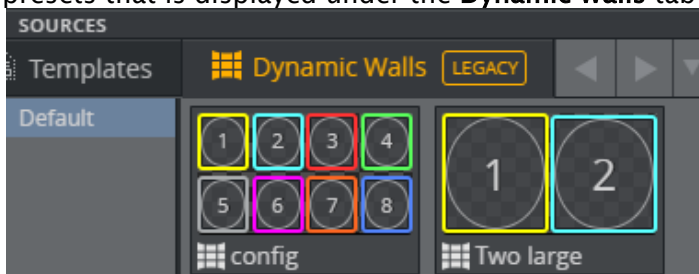

5. If you want to organize your presets in groups, you can create new groups in the Videowall playlist, or keep the existing **Default** group.



6. Create presets in a group by clicking **Add (+)**:

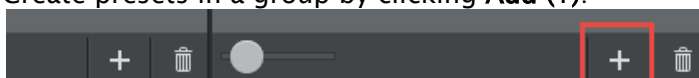



**Note:** Presets created in the video wall playlist should be thought of as templates. These presets cannot be played out directly, unless you are in the Video Wall Designer. The purpose of this step is to prepare a set of basic presets that can be used later when the content of the show is created. Presets are created with a 4 x 2 layout by default.

7. Right-click a group to connect it to a video wall in the active profile.
8. Select the Video Wall this group should represent.

## Edit Presets

1. Right click **Presets** in the Dynamic Walls tab and enter the Video Wall Designer.
2. You can reorganize the layout of the GFX channels in the designer.
3. **Save** the presets when you are finished.

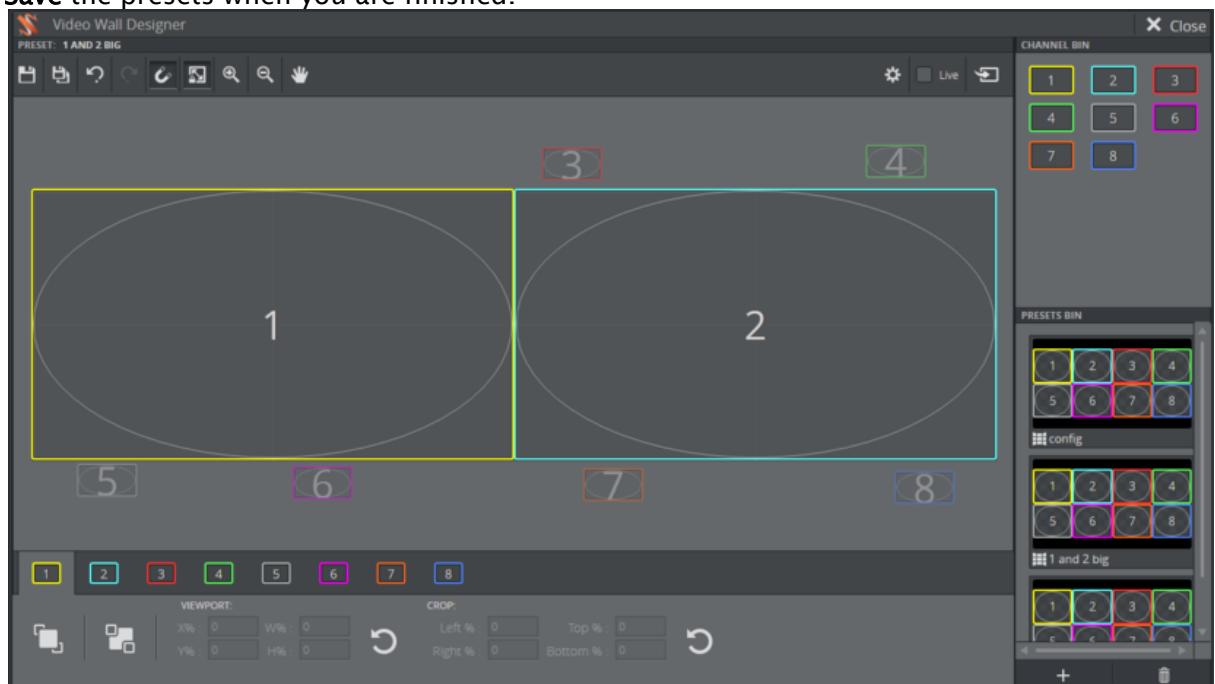

**Tip:** Play out the content in the renderer in all the GFX channels before adjusting the GFX channels in the Video Wall Designer. This allows you to click **Take** or check the **Live** box from within the Video Wall Designer. The positions and dimensions of the content adjust automatically when you are working in the Video Wall Designer.

**Tip:** If you want GFX channels to not be visible in a preset - do not disable them. In terms of performance, it is better to drag the presets outside the video wall area and/or resize them to a smaller size.

## Fine-tuning GFX Channels

After working with presets in the Video Wall Designer, you will have some preset templates with different layouts.

To fine-tune the size or positions of the GFX channels, do the following:

1. Enter the Video Wall Designer and click **Take**.
2. Return to the main GUI in Viz Multiplay.
3. Play some content out in each GFX channel and enter the Video Wall Designer again.
4. Now check the **Live** box and fine-tune the GFX channels.
5. The output on the physical screens will update live as you adjust the GFX channels in the Video Wall Designer.

## Presets Tab

When a set of presets is created in the DynamicWalls source area, drag the presets you want to use in the show into the Presets tab in the Shortcuts area. Create more tabs in this area and organize your presets here.



**Note:** You can set the aspect ratio for a GFX channel that is only used to play out elements with a special aspect, like portrait images, for example. Thumbnails and GFX channels in the Video Wall designer will then respect this aspect ratio. This will not affect playout, only how the elements are displayed in the UI.

### See Also

- [Using the Shortcuts Bar](#)

## 2.6 Settings

Open the Settings window from the toolbar.

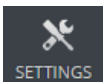

This section covers the following topics:

- [Color Correction](#)
- [General](#)
- [Inboxes](#)
- [MOS Configuration](#)
- [Pilot DB Config](#)
- [Profiles](#)

- [Servers](#)
- [Workspaces](#)

## 2.6.1 Color Correction

Correct colors for a monitor or group of monitors on a video wall:

- [Select Profiles and Walls](#)
- [Map Outputs to Monitors](#)
- [Create a Preset](#)
- [Adjust Colors and Other Options](#)
- [Grouping Screens](#)

### Select Profiles and Walls

Load the wall you want to edit:

- Select the **Profile** and **Wall** from the drop-down menus:

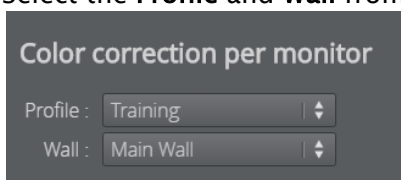

### Map Outputs to Monitors

Map outputs (1) to cubes (2). This is usually only done once.

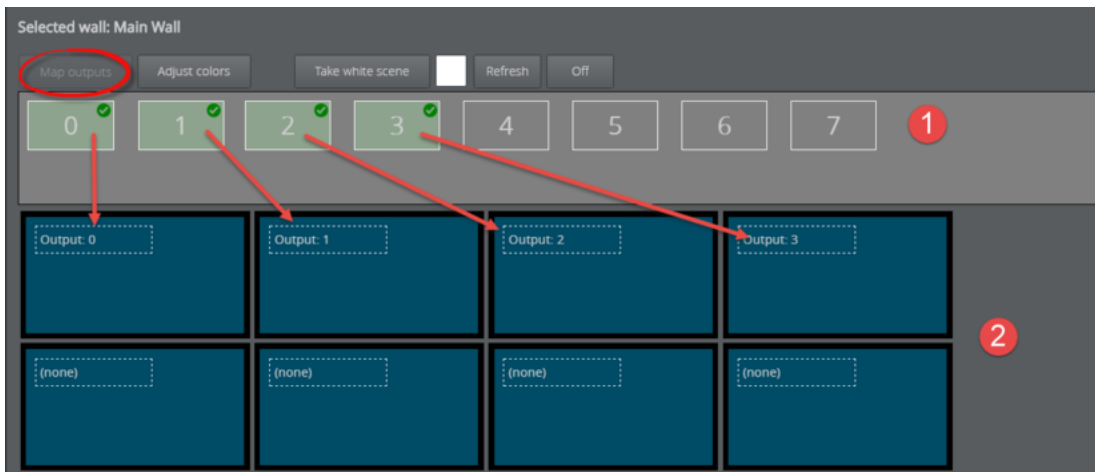

Drag outputs onto cubes (the physical screens on your video wall) to map them. For the sake of organization, the cube layout should ideally match the layout of the actual video wall.

**Note:** The **Map outputs** view opens by default as long as there are remaining outputs that need to be mapped. The **Color correction** tab always opens to the **Adjust colors** view once outputs are mapped.

The easiest way to match outputs with screens is to load a white scene.

1. Click **Adjust color > Take white scene**. All monitors on your video wall now display white.



2. Click an output.

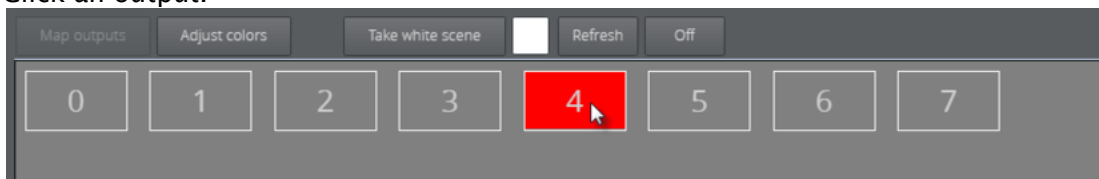

3. The video wall screen matching the output turns red. Below, the bottom left screen corresponds to output four:

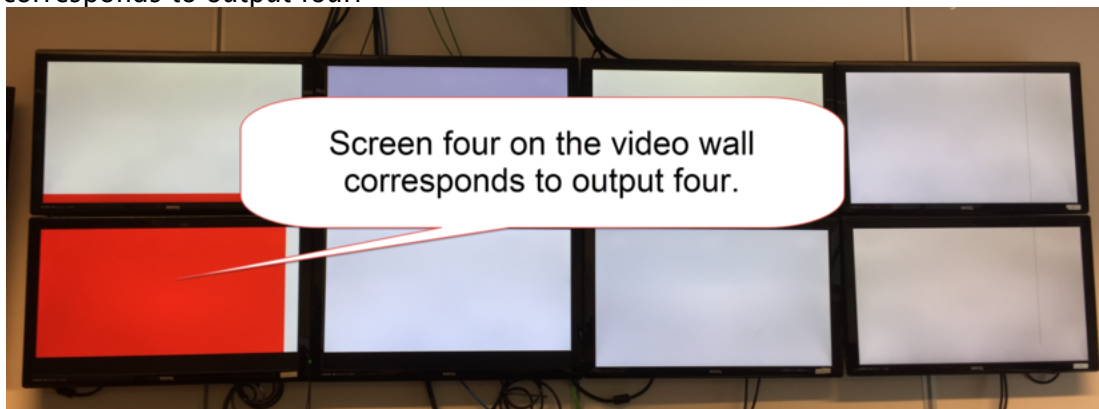

4. Then drag the output to the same position in the editor to map.

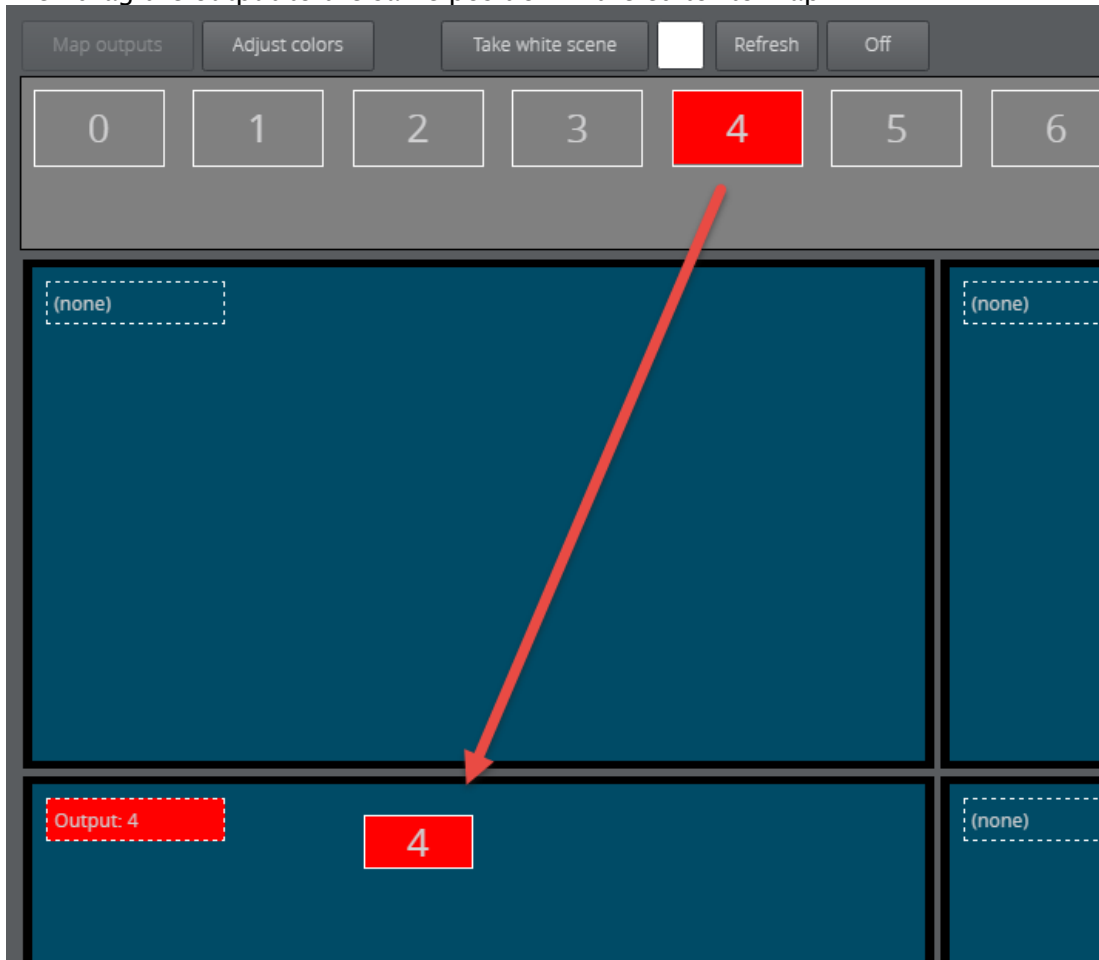

**⚠ Note:** Remember that graphics channels feed content to the screens. Channels are mapped to screens in the output. In the video wall above, output four is mapped to screen four, which could be receiving content from any GFX channel.

5. Map output 1.

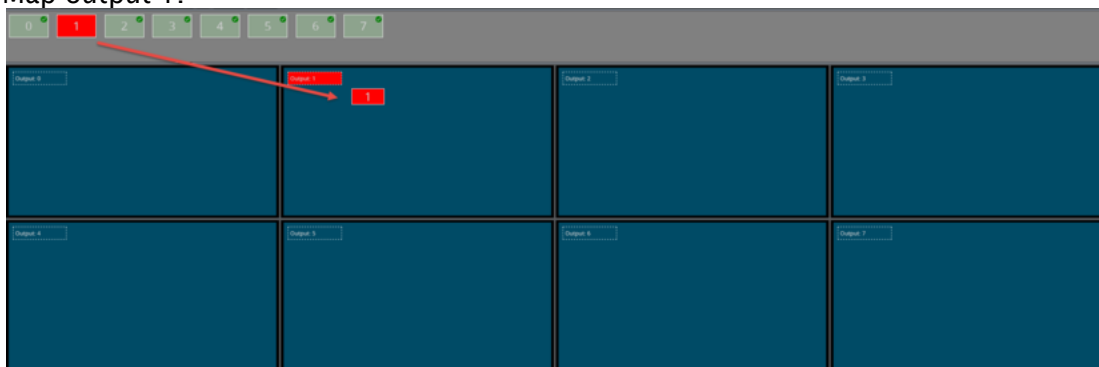

**⚠ Note:** The output turns green and a check mark appears when it is successfully mapped to a monitor.

✓ **Tip:** Unmap an output by hovering the mouse over a mapped cube and clicking the red icon.

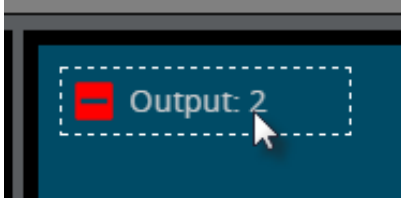

## Create a Preset

Create a color correction preset. This is useful in the case of multiple shows where each requires screens with different color intensity. A blue border appears around selected presets.

1. Click the **Adjust colors** button.

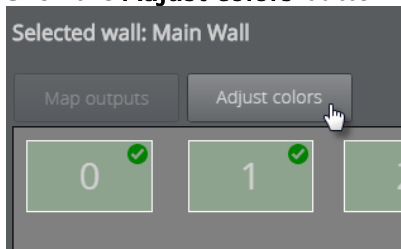

2. Click the **Add new color preset** button.

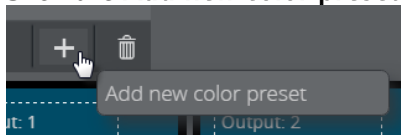

3. Give it a name and press **ENTER**.

## Adjust Colors and Other Options

Adjust screen color on a monitor-by-monitor basis.

⚠ **Note:** Color corrections are only visible on the physical screen and are not shown in Viz Multiplay. You should therefore use a physical video wall when adjusting color.

- Click a cube or screen to adjust its color:

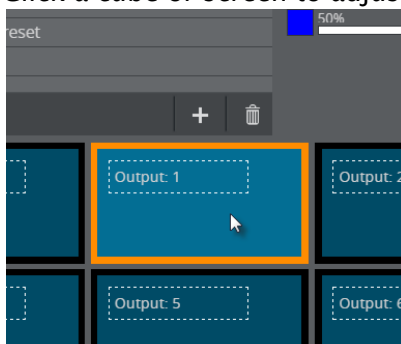

- Adjust colors in the menu below.

- Click **OK** to save the values for the selected preset.

**Note:** Changes in color correction cannot be canceled.



1. **Take white scene:** Take a completely white scene in the renderer.
2. **Select a color:** Alter the background color of the current screen.

**Note:** The **Take white scene** button must be clicked to expose the color picker.

3. **Refresh:** Sent the configuration of entire preset (all monitors) to air.

**Note:** You can also send presets to air using commands in the media sequencer.

4. **Off:** Removes all currently-applied color corrections for the video wall.
5. **RGB sliders:** Click or drag along the slider to adjust the screen's RGB intensity. Select a value between 50 and 150%, where 100% is default. For example, a 50% setting for red will deprive media in that screen of red.

**Note:** The luminosity in the color block next to the slider brightens or dims to reflect changes in luminosity. View the monitor on the physical video wall to see the changes in real time.

## Grouping Screens

Apply the same color correction edits to multiple screens.

1. In **Adjust colors** view, hold down **CTRL** and click the screens you want to group together.

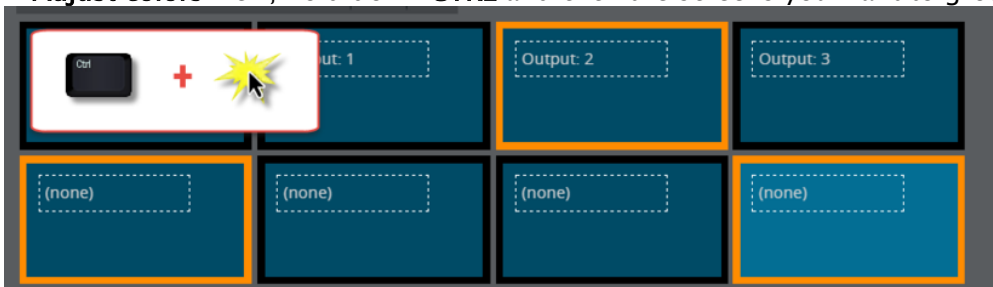

2. Right-click a screen and select **Group**.

## 2.6.2 General

In this section you can find a description of the General Settings:

- [Settings for Show](#)
- [Local Settings](#)
- [Layout Settings](#)
- [Media Sequencer Settings](#)

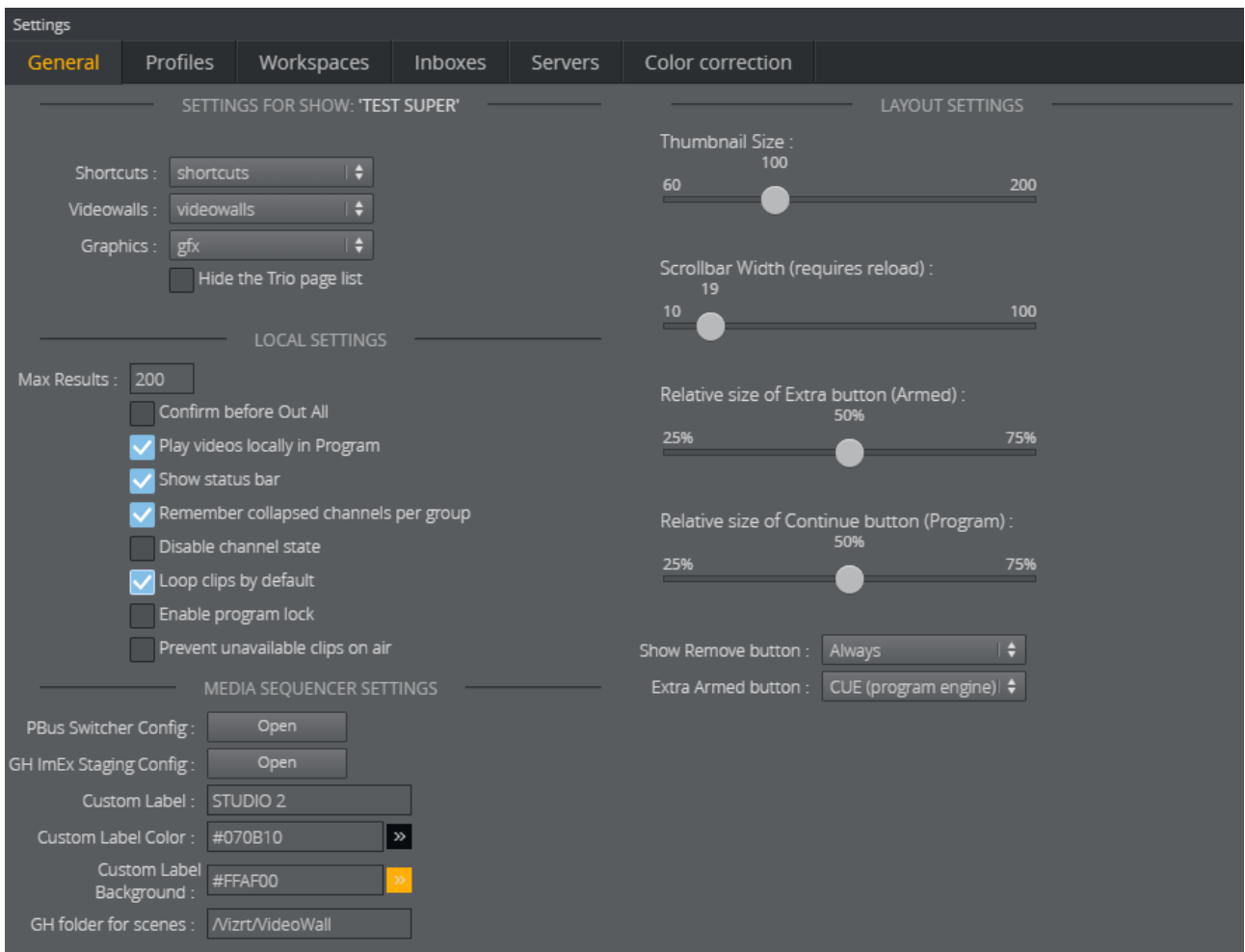

### Settings for Show

- **Shortcuts:** Select the playlist that contains your preset layouts and background scenes. The shortcuts are then displayed in the Shortcuts Bar at the top of the main window.
- **Videowalls:** Select the playlist that contains your Dynamic Channels videowall presets. This playlist will appear in the Dynamic Walls tab in the Sources area.



**Note:** The Videowall setting is discontinued for Superchannels. Superchannels presets are imported from the profile and appear automatically in the VideoWall tab in the Sources area.

- **Graphics:** Select the playlist that contains imported graphics. This playlist will appear in the GFX tab in the Sources area
- **Hide the Trio page list:** This can be useful if the Viz Pilot workflow is used. The Trio page list is a special playlist that lets the Viz Trio operator use numeric callup codes to play out graphics. In Viz Multiplay, the page list behaves like a regular playlist.

### Local Settings

- **Max Results:** Enter the maximum number of elements to be listed in the Scene importer, the Media tab and Pilot data elements in the Templates tab in Sources.

**Note:** The current search refreshes when a setting is changed.

- **Confirm before Out All:** When you click **Out All** a confirmation message appears:

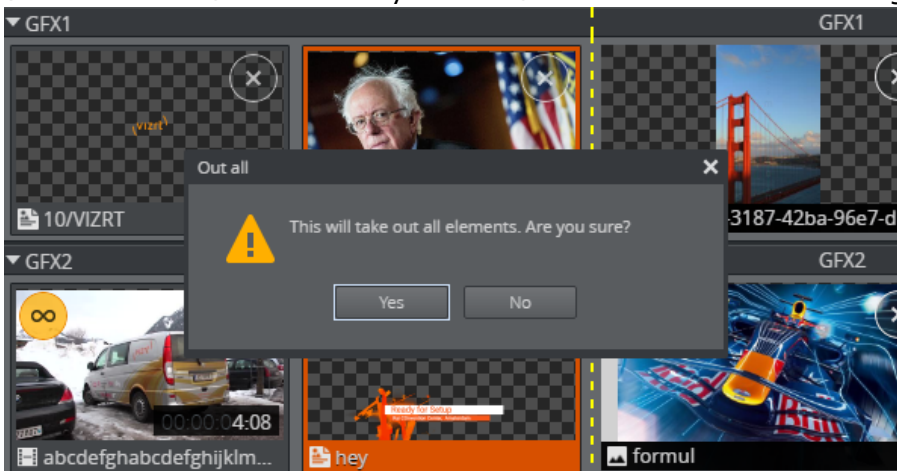

- **Play videos locally in Program:** Show a preview in the **Program** column when clips are taken to air; a thumbnail is displayed when enabled.

**Note:** See [Armed](#) and [Program](#) for more information about cueing content.

- **Show Status Bar:** At the bottom of the screen.
- **Remember collapsed channels per group:** The collapsed/expanded state for each channel is stored per group. This is useful if one group contains content for a subset of the channels, while another group mainly contains content for another subset.
- **Disable channel state:** Shows the last element taken in the Program column, this element is restricted to Viz Multiplay. The Out and Continue buttons will only operate on this element. Other clients will not update the Program column. When unchecked, Channel State is used for Media Sequencer version 5.0 or higher. When Channel State is used, the Program column contains a more accurate snapshot of the content of the renderer and the Out and Continue buttons operate on all layers currently in the renderer. In Arm and Fire setup, channel state

also provides accurate information in the Armed column from Media Sequencer and Viz Engine.

**Note:** Channel state must be enabled for Arm and Fire workflow. Video walls configured to use Arm and Fire setup will not function properly if channel state is disabled.

- **Loop clips per default:** Applies clips dragged in from a Media search.
- **Enable program lock:** Prohibits playout for a channel, including playout by other Viz Multiplay clients who have the lock enabled locally.
- **Prevent unavailable clips on air:** Clips that are flagged as unavailable to the playout engine are not available, preventing a clip that has not been transferred to the playout engine from being played out. Disabling this setting makes all clips available to the operator.
- **Custom Label:** Enter a free text and specify the background and foreground color to be displayed as a label in the toolbar area. This indicates at a glance which video wall or studio the interface is controlling:

This is displayed in the interface:

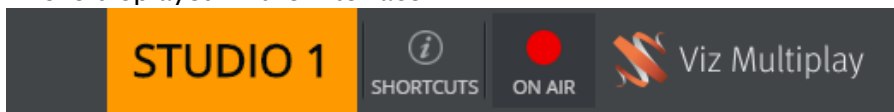

- **GH folder for scenes:** The default Graphic Hub path for the scenes in the DynamicChannels archive and for the Superchannels scenes.

## Layout Settings

- **Thumbnail size:** Of media icons in the Media column.
- **Scrollbar Width** (in pixels): For the vertical scrollbar in the Media pane, where the default is 19. This can be handy when operating on a touch device.
- **Relative Size of Extra button (Armed):** Applies the Armed column (see below).
- **Relative Size of Continue button (Program):** Makes Continue bigger so it stands out. Useful in preventing the operator from accidentally clicking Out instead of Continue in stressful situations.
- **Show Remove button:** Shows the X on playlists and elements. Use this to prevent accidental removal of elements and playlists:
  - Always
  - Only when Off Air
  - Never
- **Extra Armed button:**
  - None

- **CONTINUE:** Performs a continue operation on the external preview engine for a video wall, if preview is configured.
- **CUE:** Sets the armed element at its first frame in the Program column.
- **TRANS:** Swaps the content of the Armed and Program columns.

## Media Sequencer Settings

- **PBus Switcher Config:** Available if Media Sequencer supports the [PBus protocol for communicating with switchers](#) (requires Media Sequencer version 5.0 or higher). A new browser tab opens with the configuration application for communicating with the switcher.
- **GH ImEx Staging Config:** Available if Media Sequencer supports image staging to Graphic Hub (requires Media Sequencer version 5.0 or higher). A new browser tab opens with the [configuration application for the ImEx service](#), and all images in the active playlist originating from HTTP resources are automatically transferred to the Graphic Hub. The transfer status is shown on top of the images in the Media column. The status disappears once the image has been transferred to the Graphic Hub. This reduces the delay when the image is played out on air. Although the image still has to be transferred from the Graphic Hub to the Viz Engine on a Take, this operation is usually quicker than loading it from an arbitrary HTTP resource.

 **Tip:** To reduce delay even more, initialize the show containing the image; the Viz Engine will then load the image from Graphic Hub into the memory.

 **Note:** The ImEx Staging Configuration application does not support HTTPS. Therefore in a secure environment, the config app must be manually opened in the browser using: <http://mse-host:8580/app/stagingconfig/stagingconfig.html>.

### 2.6.3 Inboxes

Inboxes are sources of content that are always available as an **Inbox Tab** in the [Finding Media and Content in Sources Pane](#). You can configure multiple inboxes.

Any show on Media Sequencer can be used as an inbox.

 **Note:** The inboxes you configure are global, so they will be available in all shows.

Go to **Settings > Inboxes**:

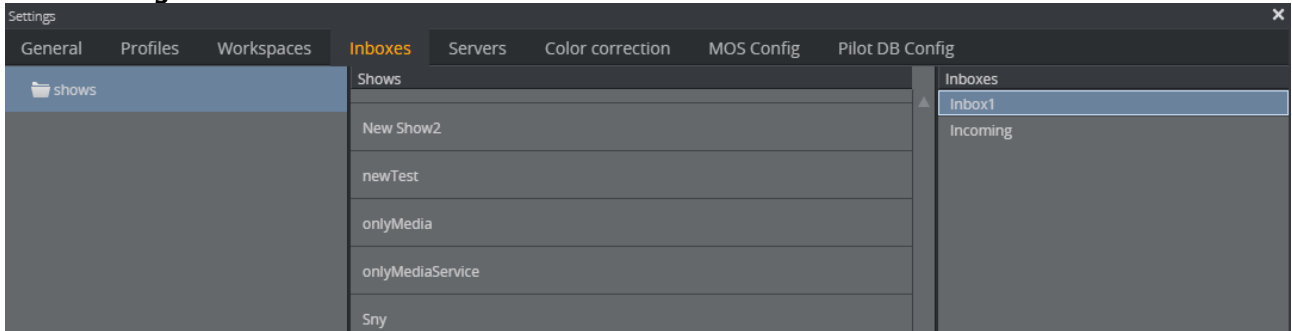

Configure a Show as an Inbox by dragging the show from the **Shows** list to the **Inboxes** list, it will then appear as an **Inbox Tab** in the **Finding Media and Content in Sources Pane**, as shown below. Any content added to this show will be available as an **Inbox** tab, and can be dragged to a channel.

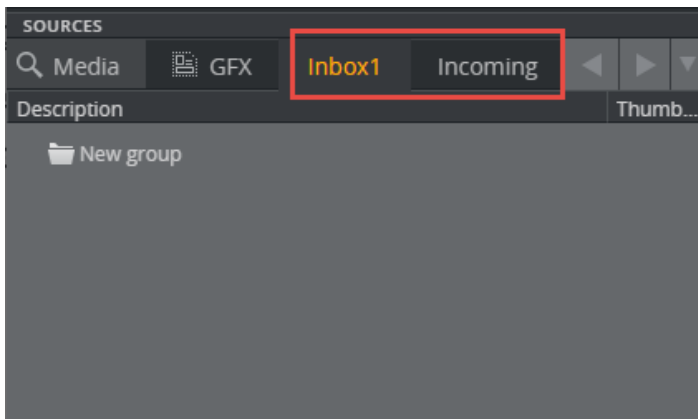

## 2.6.4 MOS Configuration

Viz Multiplay can be used as a MOS client. This means that the rundown is created in a Newsroom Computer System (NCS). The rundown can be transferred to the local Media Sequencer via the newsroom gateway and Viz Gateway and controlled by Viz Multiplay.

### Setting up Viz Gateway to Act as a MOS Client

Media Sequencer must first be configured to connect to a Viz Gateway, which connects to multiple NCSs. All the rundowns controlled by Viz Gateway will then be listed when you add an external playlist to a show in Viz Multiplay .

Open **Settings > MOS Config**:

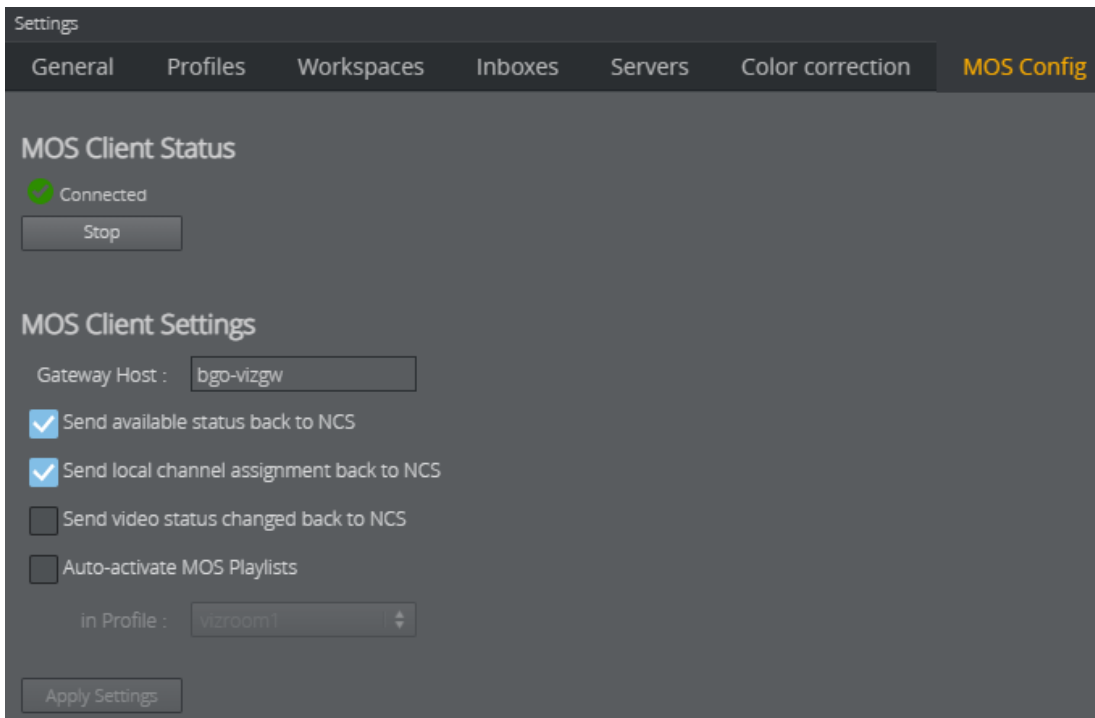

## MOS Client Status

In this scenario, the MOS client is Media Sequencer. The MOS client must be configured to communicate via the MOS protocol to a Viz Gateway.

- **MOS Client Status** shows whether Media Sequencer is able to connect to Viz Gateway.
- You can also **Start** and **Stop** the local client.

## MOS Client Settings

- **Gateway host:** Host name or IP of the machine running Viz Gateway.
- **Send available status back to NCS:** Sends the available status for elements containing clips and/or images back to the NCS as Ready or Not Ready.
- **Send local channel assignments back to NCS:** It is possible to make last-minute changes to an element's playout channel in Viz Multiplay. Media Sequencer will then send this channel assignment back to the newsroom system if this setting is enabled. If this setting is disabled, the local change may be overwritten on the next update from the newsroom system.
- **Send video status changed back to NCS:** Sends the clip playback status (CUED, PLAYING, STOPPED) back to the NCS.
- **Auto-activate MOS playlists in profile:** If no client application operates the MOS rundown and if it is controlled by an automation system (for example, you can auto-activate all MOS playlist for a specific profile).
- **Apply Settings:** Applies the changed settings without closing the window. This button is only enabled when changes have been made.

## 2.6.5 Pilot DB Config

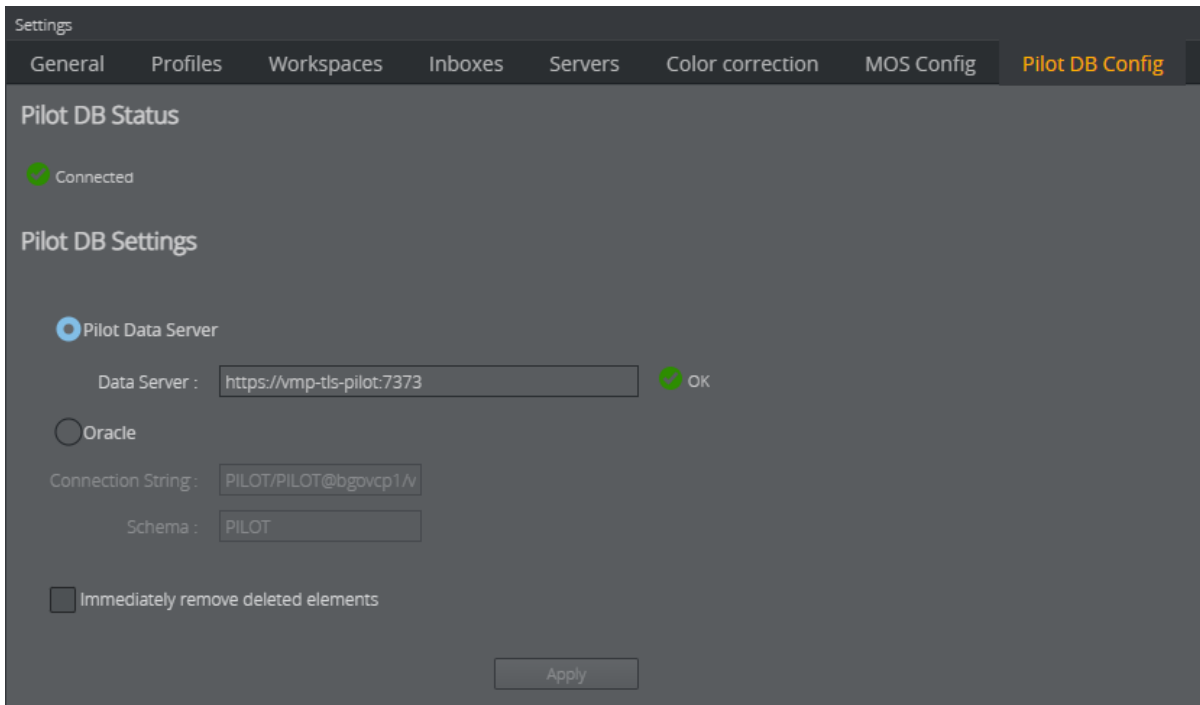

This tab configures the Media Sequencer connection to the Pilot Database. Whenever a reference to a Viz Pilot playlist element is inserted into a playlist in Viz Multiplay - this configuration will make sure that the Media Sequencer immediately downloads all relevant data from the Pilot database. The playlist element is then ready for playout through the Media Sequencer.

Note that this tab does not support the **Cancel** button. Any change in this tab will take effect when clicking Apply, and it is not possible to undo by clicking Cancel.

## 2.6.6 Profiles

### Profiles

Profiles are used to create different playout channel setups. Each playout channel represents one or more Viz Engines.

Use the **Profiles** tab under **Settings** to individually configure Profiles, Channels, Viz Engine handlers and Viz Video handlers, and to configure video walls.

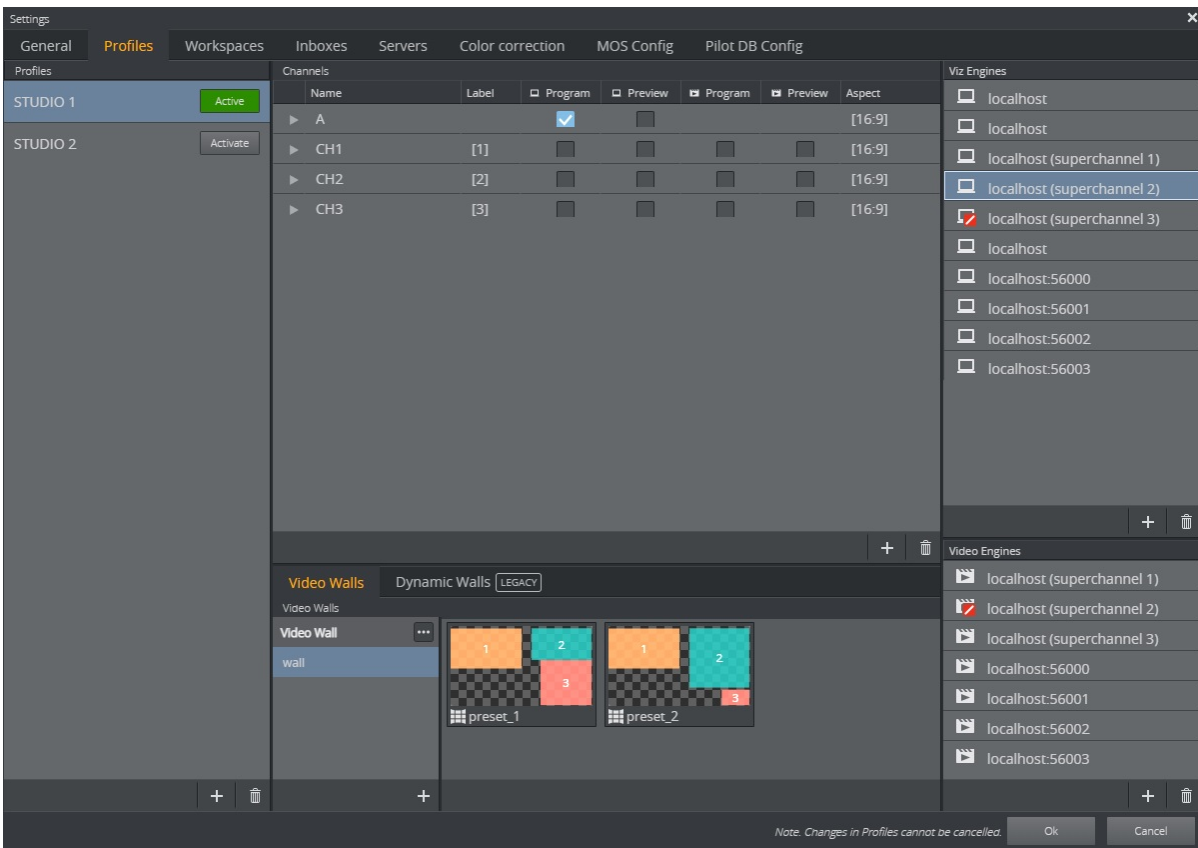

**Note:** The Profiles tab is similar to profile configuration in Viz Trio and Viz Pilot. It uses the same data as Viz Trio, so changes made via either application are reflected in both.

**Note:** Profile changes cannot be canceled.

Activate/Deactivate profiles using buttons in the Profiles list:

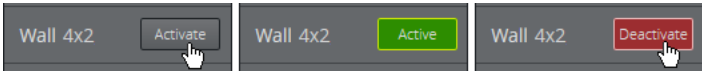

**Note:** Always set the Active Profile for a show in Viz Multiplay. If a show is activated by a Viz Trio client, then it will be deactivated if that Viz Trio client shuts down and Viz Multiplay will lose its active profile.

**Note:** Renaming an active profile (from Viz Trio or Viz Multiplay) automatically deactivates the profile. Go back to **Settings > Profiles Tab** and click the **Activate** button for the profile again.

### Configuring Channels

Content can be played out on multiple channels, with as many outputs as desired. Typically, each channel has multiple outputs and each output is a single Viz Engine. In a typical video wall setup, Viz Multiplay creates one main channel with one Viz Engine output to the default Viz Engine port

(6100) and a number of channels with one Viz Engine output for graphics and one Viz Engine output for video. Port configuration for these handlers depends on the video wall type: port numbers by default start from 55000 on legacy configuration with GFX channels, and from 56000 on Superchannel video walls. In the new Arm and Fire setup all handlers address the main channel port (6100).

**Note:** When elements are added to the channels in the [Media Pane](#), the channel name is reflected in the Viz Trio page list. However, in Viz Trio you can also specifically assign elements to channels. If an element is assigned to a channel name that is not present in the active profile, then that element will not be visible in Viz Multiplay. The element will also not be visible if the element's channel is hidden in the active workspace.

Elements that are assigned to the [PROGRAM] channel will be displayed in the channel set to viz/video program in the active profile in Viz Multiplay, regardless of the channel's name.

**Note:** Main channel refers to the main channel of a video wall, while [PROGRAM] refers to the program channel of the profile.

**Note:** Adding videos to a graphics-only channel or graphics to a video-only channel will result in the element not being played out correctly. Composite elements will only work on channels that support both graphics and video.

## Handlers

Each Viz and Video handler represents one Viz Engine with graphics or video capabilities. When creating a video wall in Viz Multiplay, all handlers are auto generated. It is also possible to explicitly create a viz or video handler:

- Click the plus button in the list of viz or video handlers.
- Fill in host and port.
- Check the Superchannel checkbox if this handler represents a Superchannel.
- Select an asset storage publishing point for transfer of Viz One clips to the given viz engine host. These storage points are read from the Viz One server specified in **Settings > Servers**.
- Set the Delay to globally delay playout on this handler by a number of seconds, including fractions, ie. 1.5. All playout commands on this Viz Engine is then delayed by the given



duration. This mechanism will not be frame accurate.

**Note:** The delay applies all attempts to play out elements in the channel from both Viz Multiplay, and other applications like Viz Trio or Director.

## Adding Custom Labels to Video Wall Channels

When adding a video wall to a profile, the different areas of the video wall are represented as channels. These are prefixed CH or GFX, for instance CH1, CH2, CH3 etc. In the different parts of the GUI, these channels are equivalent to their numbers, for instance in a video wall preset, the channel CH1 is just shown as the number 1 in the thumbnail where it appears. Though, it is possible to assign custom labels to the different video wall channels. When filling in content into the presets, it may be easier for the operator to identify the channels by names instead of number:

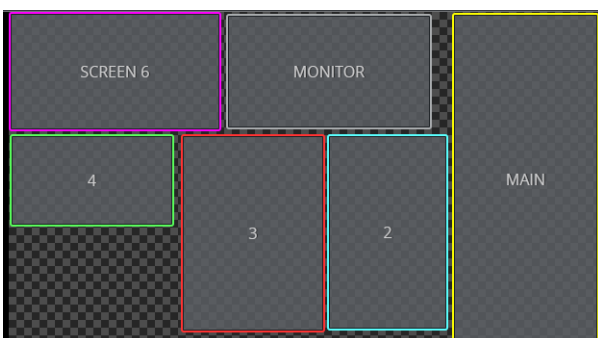

To assign labels to different video wall channels, go to **Settings > Profiles**, click a profile and modify the labels in the Channels column:

Channels	
Name	Label
▶ A	
▶ CH1	MAIN
▶ CH2	[2]
▶ CH3	[3]
▶ CH4	[4]
▶ CH5	MONITOR
▶ CH6	SCREEN 6

## 2.6.7 Servers

The **Settings > Servers** tab contains configurations for the Viz Multiplay client. The configuration is stored on Media Sequencer and will affect all other Viz Multiplay clients.

- Enter a host name or IP and click tab on the keyboard.
- Viz Multiplay will assist and suggest the full default URL of the service.
- If Viz Multiplay is hosted from a HTTPS address, the HTTPS URL of the server is suggested.

The screenshot shows the 'Settings' window with the 'Servers' tab selected. The 'SERVER SETTINGS' section includes:

- Preview Server:  OK
- Viz One:  OK
- Data Server:  OK
- Media Service:  Not Connected
- Graphic Hub:  OK

The 'GRAPHIC HUB CREDENTIALS' section includes:

- Username:
- Password:

**⚠ Note:** Multiple search providers can be used. However, we do not recommend configuring a Viz One and a Media Service simultaneously.

## Preview Server

A Preview Server is needed to create live thumbnails and to display a snapshot of graphics when being edited. Without a Preview Server, Viz Multiplay will fall back to default thumbnails from Graphic Hub, and they may not be accurate.

## Viz One

When configuring a Viz One server in Viz Multiplay, it appears in the search providers in the Media pane in Sources. To transfer videos to the playout Viz Engine, the publishing point for the video wall or video channel in the profile must also be configured. Media Sequencer will then actively monitor for added clips to the show or playlist, and start transferring a clip when needed.

## Data Server

If a Pilot Data Server is configured, you can access the Viz Pilot workflow. Access Viz Pilot concepts and templates by dragging templates from the [Templates Tab](#) to your channels. Note that this setting is private for Viz Multitplay only. To make the full system configuration work, Media Sequencer must be configured to use the same Pilot Data Server when connecting to a Viz Pilot system. This can be done in the [Pilot DB Config](#) tab in Settings.

## Media Service

A Media Service can be used in smaller setups with a limited amount of media assets. In this case the Media Service is only a proxy for the media in a folder on a disk, and will not support metadata or advanced MAM features.

## Graphic Hub

A Graphic Hub is needed to browse for scenes when importing graphics. It also appears in the search providers in the Media pane in Sources. With this workflow it is possible to use Graphic Hub as an image provider.

## Connection Status

Icons next to the URL input boxes show the status of the connection to the server. The status is indicated based on whether the service document of the given URL can be reached. Note that there is no guarantee that the service itself will work properly if the system is not configured correctly. The status only says that the URL is reachable and responds as expected.

## Graphic Hub Credentials

Enter the Graphic Hub credentials when communicating with the Viz Engine during adding or editing of video walls. This will suppress a browser popup in this case, but note that a browser popup will appear whenever the browser needs user credentials to communicate with Graphic Hub in all other cases.

## 2.6.8 Workspaces

Workspaces can be used to adapt the GUI to one specific role, such as the anchor in the studio or the person responsible for playing out a part of the video wall or control one of several different video walls. In each workspace, you can:

- Hide channels that should not be visible for the Viz Multiplay operator.
- Specify a custom set of shortcut tabs, shared or private to the workspace.
- Specify a keyboard shortcut to activate this workspace.

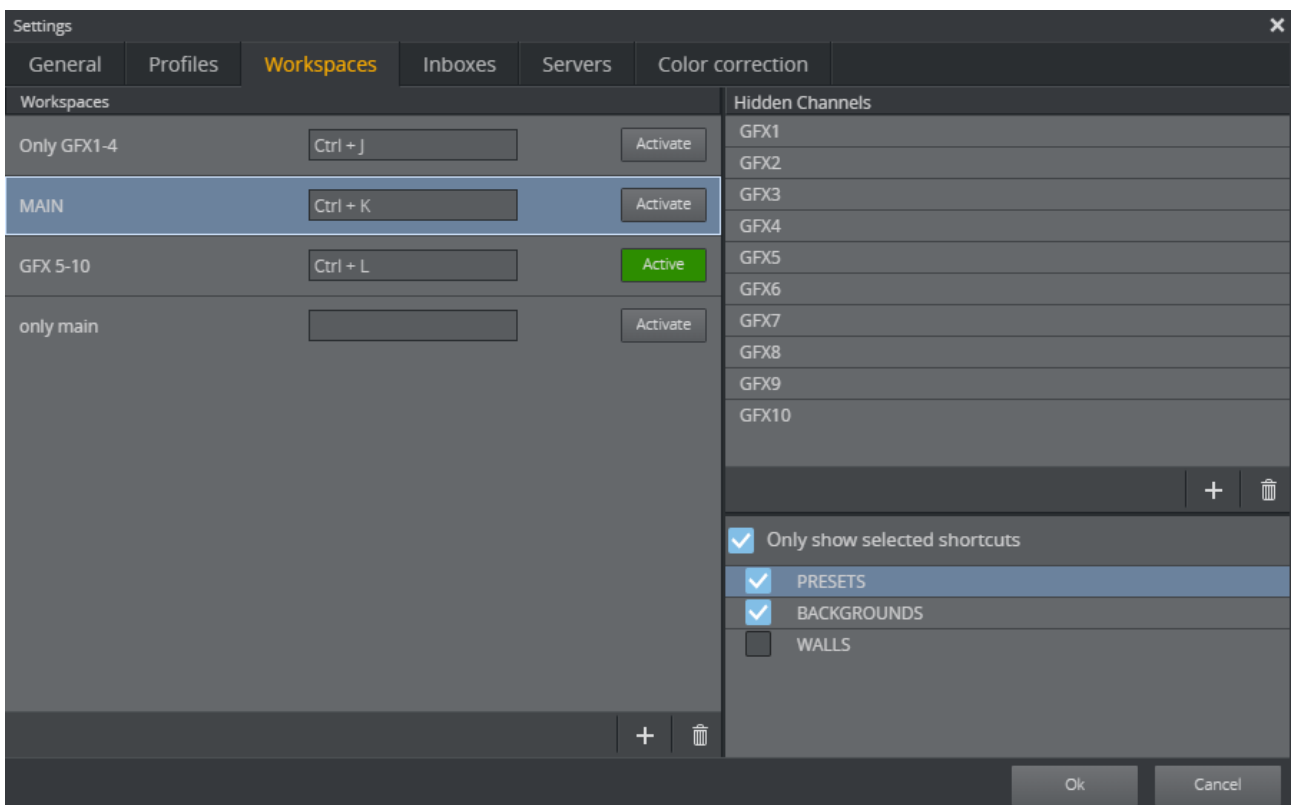

### Creating a New Workspace

1. In the **Workspaces** pane on the left, click **Add (+)**, and give your new workspace a name.
2. In the **Hidden Channels** pane on the right, click **Add (+)** and type the name of the channel that you want to be hidden in this workspace.
3. Set the active workspace for this user by clicking the **Activate** button.

### Hiding Channels

A workspace can specify channels that should not be visible. For instance, the main channel should often be hidden from the user in a video wall setup. The main channel of a video wall is used to play out the presets, which are usually located in the Shortcuts bar. It is therefore not necessary to populate or show the main channel (normally called **A**) in the GUI.

To hide the **A** channel:

1. Go to **Settings > Workspaces**.
2. Create a new workspace by clicking the **Add (+)** button in the Workspaces list.
3. Add the names of the channels you wish to hide by clicking the **Add (+)** button in the Hidden Channels list.

✓ **Tip:** Hide multiple channels by right-clicking the Hidden Channels panel and selecting the relevant channels from the context menu.

4. Enter the name of the channel to hide.

⚠ **Note:** This hides the channel regardless of which profile is active. If you hide channel **A** in the workspace, the channel called **A** is hidden for all profiles you activate.

5. Activate the workspace by clicking the **Activate** button.

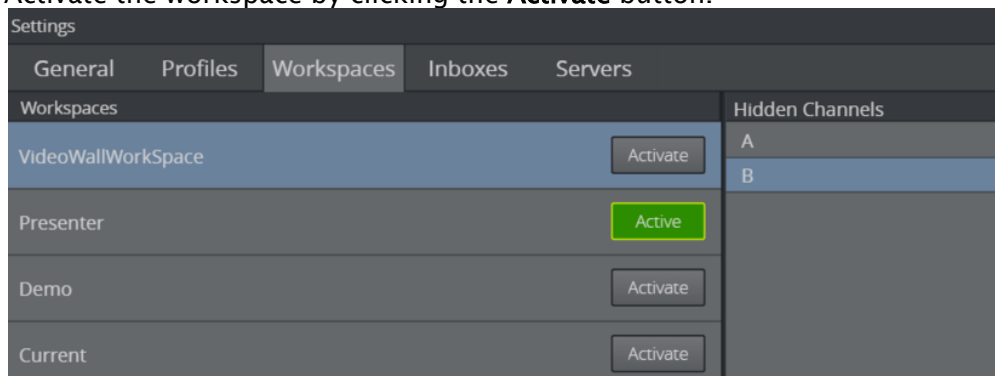

## Shortcuts per Workspace

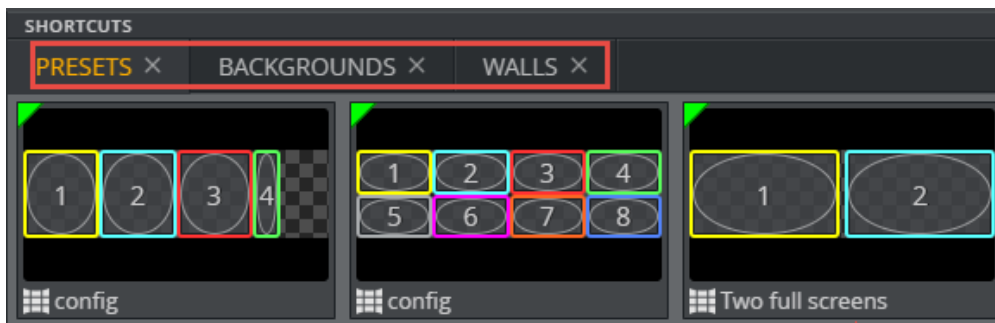

Shortcut tabs in a show can be shared between all workspaces or they can be assigned to specific workspaces.

- Go to **Settings > Workspaces**.
- Click a workspace.
- Check **Only show selected shortcuts**.
- Check one or more shortcuts group listed.

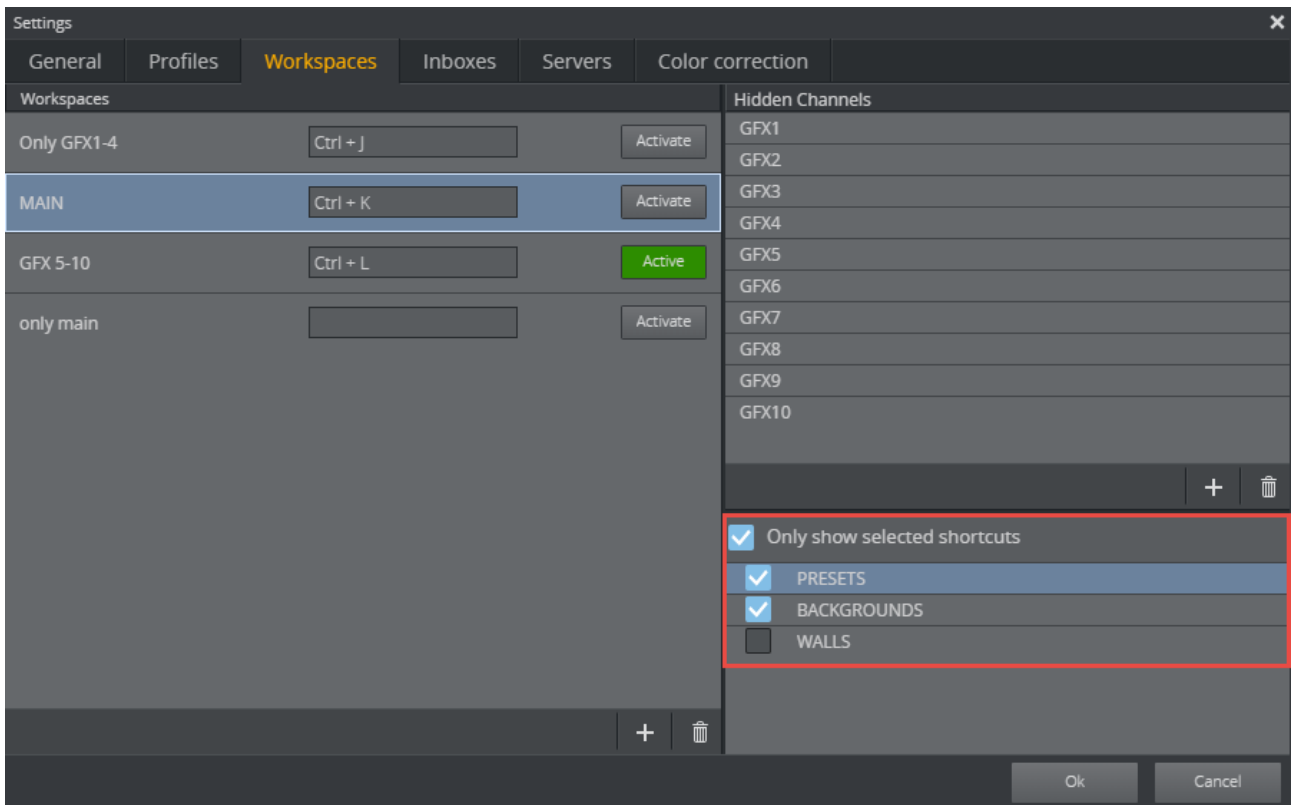

If **Only show selected shortcuts** is checked, and no workspace is active, all shortcut tabs are visible.

If **Only show selected shortcuts** is checked, and a workspace is active, only the checked shortcut tabs in the list will be active. One shortcut tab can be visible in multiple workspaces. When creating new shortcut tabs when **Only show selected shortcuts** is checked, the new tab will automatically belong to the active workspace.

## 3 The User Interface

This section describes how to work with Viz Multiplay's user interface:

- [Overview](#)
- [Keyboard Shortcuts](#)
- [Status and Logs](#)
- [Toolbar and Channels Layout](#)

### 3.1 Overview

Once a show is selected using the **Open** button, the Viz Multiplay window displays the following areas:

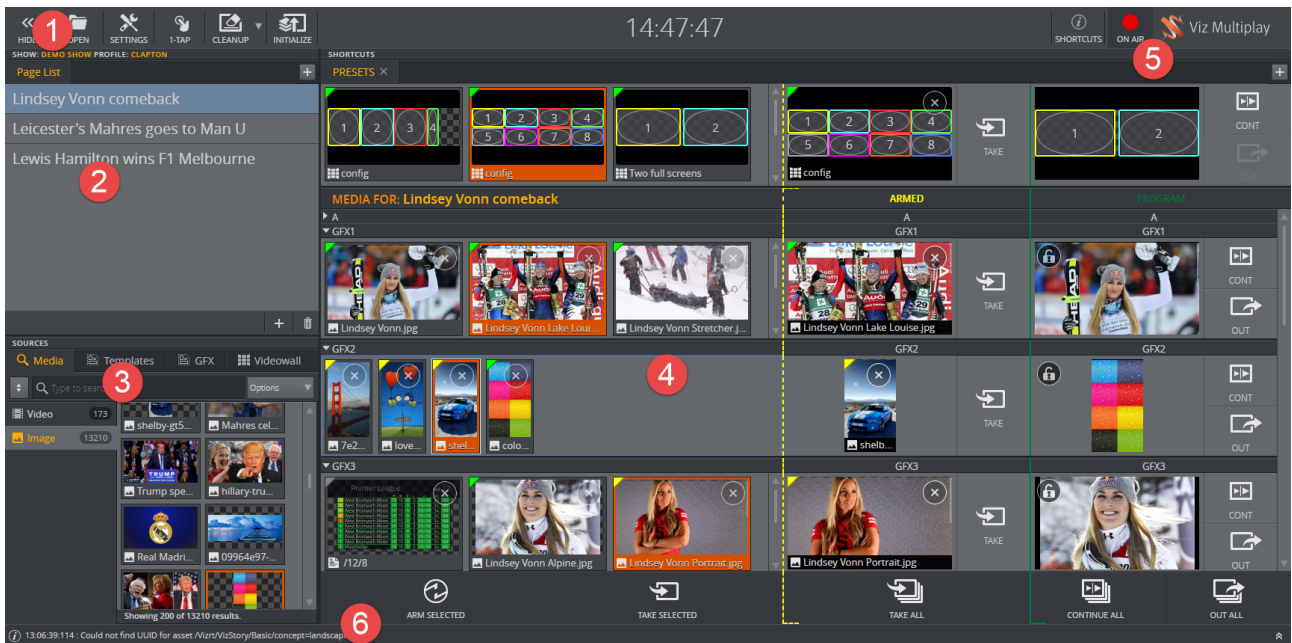

The window contains the following main areas. Click the links below for more information:

1. [Toolbar](#)
2. [Show Pane](#)
3. [Finding Media and Content in Sources Pane](#), which includes:
  - [Media Tab](#)
  - [Inbox Tab](#)
  - [GFX Tab](#)
  - [Videowall Tab](#)
  - [Templates Tab](#)
4. [Media Pane](#), which includes:
  - [Using the Shortcuts Bar](#)
  - [Media Column](#)
  - [Armed column](#)
  - [Program column](#)

- [Action Bar](#)
- 5. [On Air Mode](#)
- 6. [Status Bar](#)

## 3.2 Keyboard Shortcuts

There are different keyboard shortcuts available depending on where in Viz Multiplay you are.

The different areas where you can use keyboard shortcuts are:

- [Main Window](#)
- [Profile Configuration](#)
- [Video Editor](#)
- [Workspaces](#)
- [Video Wall Designer](#)

### 3.2.1 Main Window

Clicking this button will display a window with all the available keyboard shortcuts in the [Main Window](#) in Viz Multiplay:

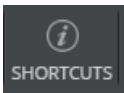

Shortcut	Action	Comment
<b>A, [number]</b>	Arm on channel.	Arm the currently selected or first element on the channel. If in 1-Tap mode, do nothing.
<b>T, [number]</b>	Take on channel.	If in 1-Tap mode, take the currently selected/first element on the channel. If not in 1-Tap mode, take the armed element.
<b>C, [number]</b>	Cue armed element on channel.	Cue the currently armed element. If in 1-Tap mode, do nothing.
<b>ALT + T</b>	Take all armed or selected elements.	Depends whether 1-Tap mode is enabled or not. If enabled, the key press will take all selected elements, and if not, all armed elements are taken.
<b>ALT + C</b>	Cue all armed elements.	



Shortcut	Action	Comment
ALT + U	Unarm all armed elements.	
P, [number]	Continue current element on channel.	Continue the currently running element(s).
O, [number]	Out the current element on channel.	Take OUT the currently running element(s).
ALT + P	Continue all elements in the Program channel.	
ALT + O	Out all elements in the Program channel.	
SHIFT + R, [number]	Re-Cue the current video on channel.	Re-cue the video element currently set on the channel.
SHIFT + P, [number]	Pause the current video on channel.	Pause the currently playing video on the channel.
SHIFT + V, [number]	Play the current video on channel.	Play/continue the currently cued/paused video on the channel.
SHIFT + C	Collapse all channels.	
SHIFT + E	Expand all channels.	
SHIFT	Reveal channels.	Hold the <b>SHIFT</b> key to reveal more info on thumbnails in the Media Pane: GFX channels on filled presets, channel on shortcuts elements, and full description.
ENTER	Take or Arm the selected element.	
DELETE	Delete the selected item.	
F2	Rename group.	

The **[number]** in the above table refers to the index of the visible channels in the Viz Multiplay GUI. The first visible channel has shortcut key 1, the second visible channel has shortcut key 2 etc. This means that if the GUI contains two channels A and B then A has shortcut key 1 and B has 2.

**Note:** [number] should be typed without any modifiers (**CTRL**, **SHIFT**, **ALT** etc.). If the combination is a key and a number, the key must be pressed and released followed by the number in two separate consecutive key presses, not a simultaneous key press combination.

### 3.2.2 Profile Configuration

The following keyboard shortcuts are related to the **Channels** list in the **Profiles** tab in **Settings**.

Click a channel and apply the shortcuts to reorder channels.

Shortcut	Action
<b>CTRL + UP ARROW</b>	Move a channel up in the list.
<b>CTRL + DOWN ARROW</b>	Move a channel down in the list.

### 3.2.3 Video Editor

The following keyboard shortcuts are available when previewing a video from the [Video Editor](#) window:

Shortcut	Action
,	Move one frame back.
.	Move one frame forward.
<b>M</b>	Mute.
<b>I</b>	Mark In.
<b>O</b>	Mark Out.
<b>SHIFT + I</b>	Go to In point.
<b>SHIFT + O</b>	Go to Out point.
<b>SHIFT + C</b>	Clear In/Out points.
<b>J</b>	Fast reverse playback.
<b>K</b>	Pause.

Shortcut	Action
L	Fast forward playback.
SPACE or CTRL + SPACE	Play/Pause.
ALT + J	Play backward at 0.5x speed.
ALT + L	Play forward at 0.5x speed.
SHIFT + J	Move ten frames back.
SHIFT + L	Move ten frames forward.
SHIFT + K	Keyboard shortcuts.
Scroll wheel	Timeline zoom.

### 3.2.4 Workspaces

In the Workspace settings, you can assign your own keyboard shortcuts to switch between workspaces. To assign shortcuts, see [Shortcuts per workspace](#).

### 3.2.5 Video Wall Designer

In the [Designing Video Walls](#), a help page for keyboard shortcuts is displayed when clicking the  button:

Shortcut	Action
ARROW KEYS	Move selection.
SHIFT + ARROW KEYS	Move selection more.
CTRL + resize	Keep the aspect ratio when scaling.
N	Enable/disable snap.
SPACE	Enable/disable the pan tool.
A	Enable/disable to keep the aspect ratio.
Z	Zoom in.

Shortcut	Action
X	Zoom out.
CTRL + click	Select/deselect multiple options.
CTRL + ALT + click	Select behind current selection.
CTRL + F	Bring selection to the front.
CTRL+ B	Bring the selection to the back.
BACKSPACE or DELETE	Delete selected items.
CTRL + Z	Undo.
CTRL + Y	Redo.
CTRL + S	Save changes.
CTRL + SHIFT + S	Save changes as.

## 3.3 Status And Logs

### 3.3.1 Status Bar

Display the Status bar by selecting **Show status bar** in the [Settings](#) window.

When minimized the Status bar shows the latest status message:

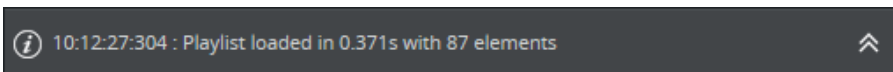

### 3.3.2 Logs

Click **Expand**  to show the Log Messages pane.

Messages can be filtered by type (Messages, Warnings, Errors) or download them into a file using the **Save log** button. Logs can be deleted by clicking the **Clear log** button.

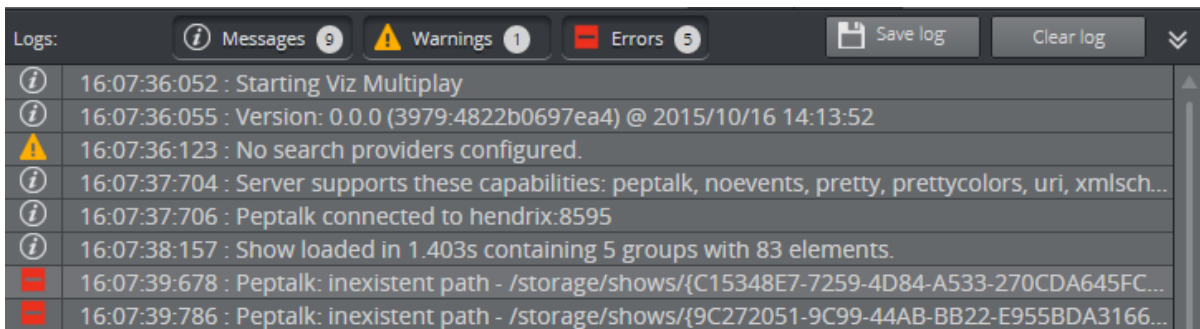

### 3.3.3 Version Information

Scroll to the beginning of the log messages to find the Viz Multiplay version information.

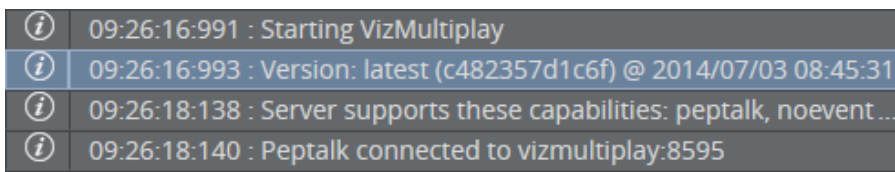

#### See Also

- [Troubleshooting](#)

## 3.4 Toolbar And Channels Layout

This section covers the following topics:

- [Toolbar](#)
  - [Tablet Set-up](#)
- [Resizing and Collapsing Channels](#)
  - [Set Custom Channel Size](#)
  - [Resizing Channels from the Context Menu](#)
  - [Collapsing Channels](#)

### 3.4.1 Toolbar



Configure how Viz Multiplay looks in your display from the toolbar using Settings, Show and Hide Sources Pane, and 1-Tap Mode.

Click on the Viz Multiplay logo for version information, as well as links to documentation and third party licenses.

- **Show/Hide:** Toggle both the [Show Pane](#) and [Finding Media and Content in Sources Pane](#) on/off.

- **New and Open:** Create a new Show or open an existing one.
- **Settings:** Open the Viz Multiplay settings window from the tool bar.
  - From the **General Tab**, you can change the thumbnail size, show/hide the status bar, and set whether to display a preview in the **Program** column when clips are taken to air.
  - Use the **Profiles Tab** to individually configure Profiles, Channels, Viz Engine handlers and Viz Video handlers, as well as easily configure video walls.
  - Use the **Workspaces Tab** to create Workspaces, which define which sets of channels are hidden from view for each type of user.
  - The **Inboxes Tab** allows setup of one or more global shows in which multiple users can ingest new elements (images, clips, graphics) simultaneously. These elements are available to the Viz Multiplay operator instantly.
  - Use the **Servers Tab** to configure preview servers and MAM systems that help to search media quickly.
- **1-Tap Mode:** When enabled, the **Armed** column is hidden and tapping an element or shortcut in the Media column will take it directly to **Program**. In this mode, elements can still be dragged between channels, or dragged to the program channel. When 1-Tap is disabled, tap arms an element. Tap in the Arm column to take it to Program. Drag elements to the preview pane to preview them.
- **Cleanup and Initialize:** Cleanup unloads resources from the Viz Engines in the current profile, while Initialize loads the scene resources of the Show onto the Viz Engines in the profile. See [Preparing and Playing Out Content](#).
- **Shortcuts:** Display the keyboard shortcuts in Viz Multiplay. See [Keyboard Shortcuts](#).
- **On Air Mode:** Click this button to toggle between on and off air mode. In On Air Mode, the button turns red and is labelled **ON AIR**. In Off Air Mode, the button is grey and labeled **OFF AIR**. Some functions in the user interface that are used for sending items to air in On Air Mode are not available in Off Air Mode. This is in order to hinder elements from accidentally being sent to air while editing a show or channel.  
The following panels and columns are hidden in Off Air Mode:
  - The **Arm and Take Multiple Elements** Action Bar.
  - The **Armed** column.
  - The **Program** column.

## Tablet Set-up

As space is limited on a tablet, a compact layout is provided automatically. You can also consider using the following display settings:

- Hide the Status bar (see [Settings](#)).
- [Hide Sources Pane and Show pane](#).
- Enable **1-Tap Mode**.
- Adjust the icon size (see [Settings](#)).

## 3.4.2 Resizing and Collapsing Channels

Channels can be custom-sized, expanded by row or collapsed entirely.

## Set Custom Channel Size

1. Hold down **ALT**.
2. Hover the cursor over the top edge of a channel header until the cursor turns into a row separator (row resize cursor).

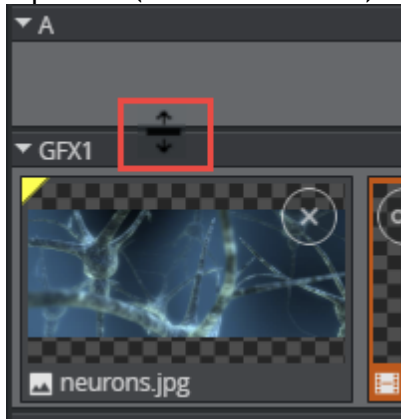

3. Drag the separator up or down as desired. When holding ALT the channels can be resized freely. Without ALT the channels are resized to a factor of the thumbnail height.

## Resizing Channels from the Context Menu

1. Right-click the channel header and select the **Set Height** menu item:

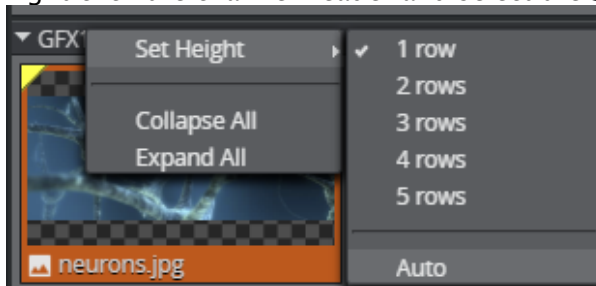

2. Select the desired row height. Select **Auto** to enable automatic creation of new channel rows when new items are added to a full row.

## Collapsing Channels

1. Click the channel header to collapse individual channels.
2. Click **Collapse All** (or **Expand All** depending on the objective).

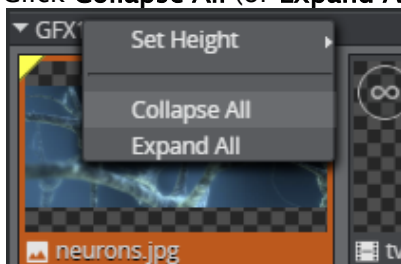

✔ **Tip:** Use the keyboard shortcuts **SHIFT + C** and **SHIFT + E** to collapse and expand all channels, respectively.

✔ **Tip:** If a profile contains several video walls, the interface can quickly become crowded with channels. Create different workspaces to hide channels. The workspace is a personal setting that is specific to each Viz Multiplay client.



## 4 Workflows

This Chapter provides an overview of supported workflows in Viz Multiplay:

- Designing Video Walls
- Importing Graphics
- Setting Up and Organizing Content
- Preparing and Playing Out Content
- Working with Filled Presets
- Working with Viz Pilot and MOS Rundowns
- Using a Switcher
- Using Graphic Hub Image Staging
- Finding Media and Content in Sources Pane
- Editing Graphics, Videos and Images
- Arming and Taking Elements
- Organizing Shows and Playlists
- Using the Shortcuts Bar

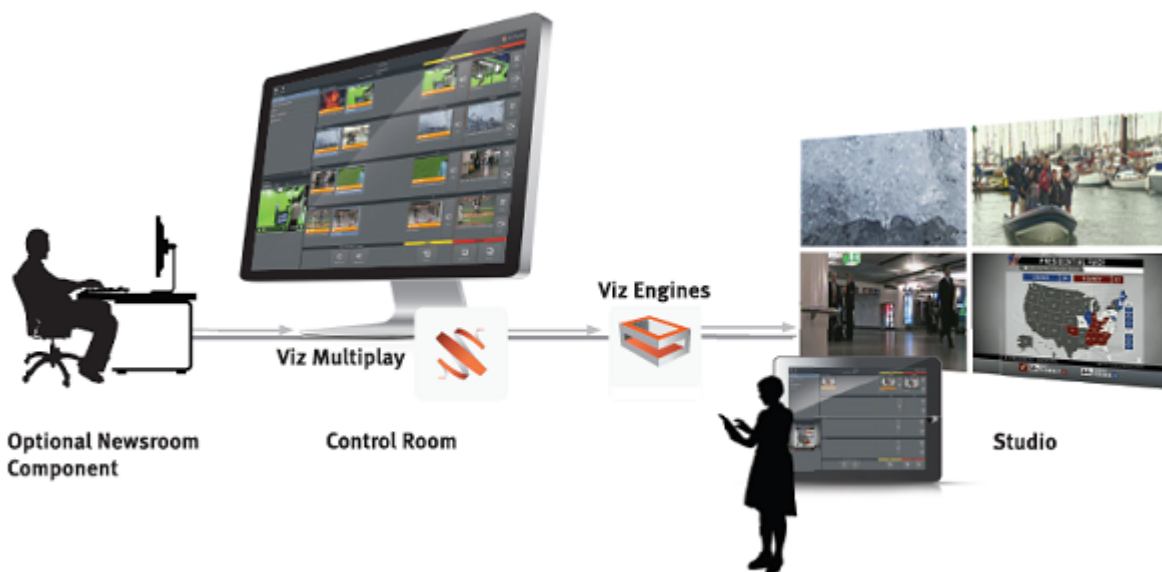

**Note:** All instances of Viz Multiplay are linked, so changes in one are reflected to all users. Users can **work in collaboration**: for example, a control room operator sets up elements for the studio presenter to take to air.

---

## 4.1 Roles In Viz Multiplay

### 4.1.1 The Journalist

1. Prepares the show. Either:
  - Browses Viz Multiplay for content (images, clips and graphics) and add to a show.
  - Prepares a show in Viz Trio or your newsroom control system.
2. Defines the channel or channels on which the content will be triggered.

### 4.1.2 The Control Room Operator

Triggers the show as it was created in the rundown or rearrange elements on-the-fly:

1. Prepares a normal rundown in the control room or newsroom. Viz Multiplay is fully MOS enabled so clips can be managed through the normal newsroom workflow using our ActiveX component.
2. In Viz Multiplay, opens a show.
3. Selects and activates a profile.
4. Selects and edits elements from the Sources pane. For example, media items, graphics, video wall layouts, or Viz Pilot templates.
5. Drags elements and arranges them in each channel:
6. Edits or previews the selected elements.
7. Drags or taps elements or video wall layouts to arm them, or take them to air: Viz Trio can trigger events from Viz Multiplay and control the content available in Viz Multiplay. Manual changes to the Viz Multiplay show are **immediately reflected** in the Viz Trio show and vice versa.

### 4.1.3 The Presenter

Controls the output on screen using a tablet:

1. Selects a media element to play.
2. Drags or taps elements to take them to air.

 **Note:** The presenter's tablet can automatically follow the control room's Viz Multiplay client to reduce the number of actions required by the presenter.

 **Note:** The physical video wall hardware is outside the scope of this chapter.

---

## 4.2 Designing Video Walls

Use the Video Wall Designer to create and modify video wall presets. Each area in the designer represents a channel where content can be played out. Create the desired layout by moving, layering and resizing the channels.

### 4.2.1 Superchannels–based Video Walls

For Superchannels-based video walls, the video wall designer is accessible from within the video wall in the profile. It is important to understand that a video wall layout (a set of presets) is represented by a Viz Artist scene. The video wall designer in this case represents all the presets inside the scene.

**Note:** One difference from the previous behavior (using Dynamic Channels) is that pressing **Save now** writes the complete scene back to the Graphic Hub and it's necessary to refresh the renderer.

#### Opening the Video Wall Designer

1. Go to **Settings > Profiles**.
2. Click the profile containing the video wall to edit.
3. In the Video Wall manager, the different video walls and their associated Viz Artist scenes are now listed.
4. Right click a preset and select **Edit Preset**.

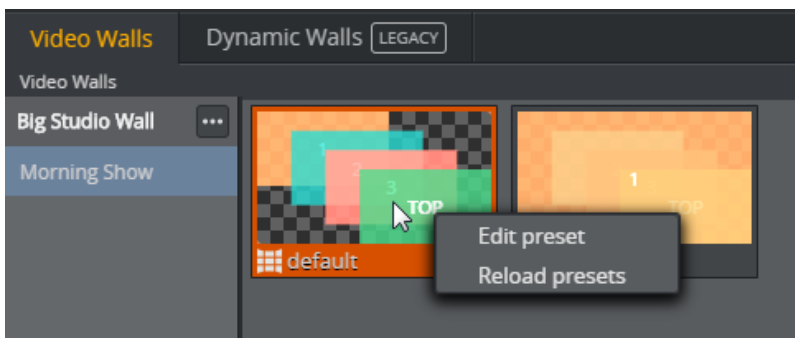

If the preset scene has changed (for instance when a designer changes the scene in Viz Artist), select **Reload presets** to display the latest changes.

### 4.2.2 Dynamic Channel–based Video Walls

There are two ways to open the Video Wall Designer using the DynamicChannels based video walls:

1. Right-click a preset in the Shortcuts Bar.

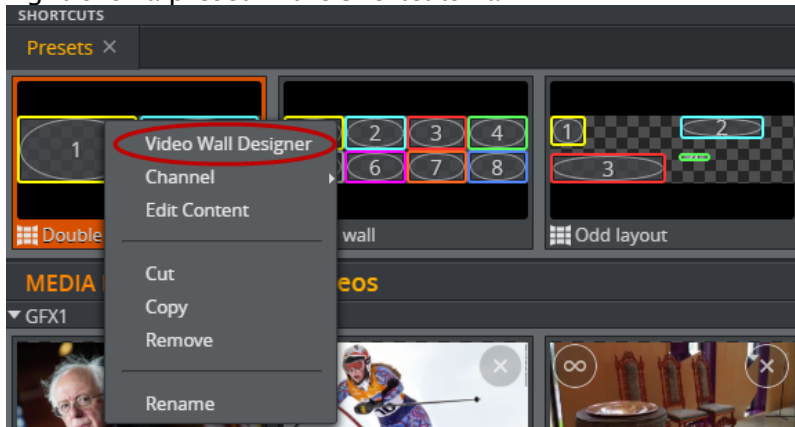

2. Right-click a preset in the Videowall Tab.

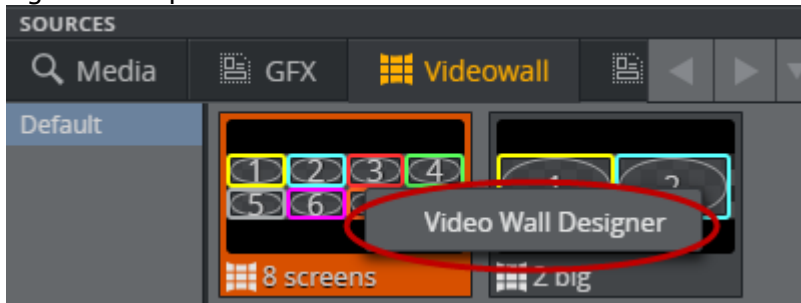

### 4.2.3 Video Wall Designer Layout

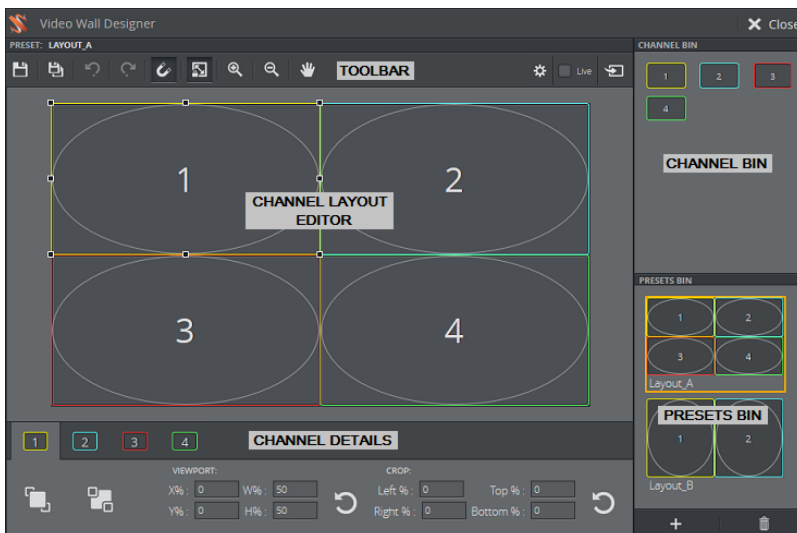

The Video Wall Designer is organized into the following areas:

- [Toolbar](#)
- [Channel Bin](#)
- [Presets Bin](#)

- [Channel Details](#)
- [Channel Layout Editor](#)

The backdrop of the Video Wall Designer layout is called the Active Areas Editor.

## Toolbar



## Left Side:

- **Save:** Save changes to the current preset (DynamicChannels) or save the preset scene back to Graphic Hub (Superchannels).
- **Save As:** Save the layout as a new preset. Not available in Superchannels mode.
- **Undo/Redo:** Undo/redo last move.
- **Toggle snapping:** Snap to a grid, to the edges of Active Areas and GFX channels.
- **Number of snap points:** The number of snap points (grid) distributed across the underlying Active Areas (the snap areas). For instance: 4 snap points will make the GFX channel snap to the edges of the underlying Active Area, and 2 in between. Increasing the snap points will make the grid finer.
- **Keep aspect ratio:** Maintains aspect ratio of the channel when the frame is cropped or resized. Also enforce the aspect given for the channel in the Profile when the GFX channel is dragged from the Channel Bin or reset.
- **Zoom in/out:** Click to zoom in or out.
- **Center:** Center the view of the video wall area. (Hint: Use the scroll wheel to zoom in and out.)
- **Pan mode:** When Pan mode is *on*, pan by dragging the background or a channel. When Pan mode is *off*, you can still drag the background to pan, but dragging a channel moves the channel. Dragging a handle always moves the handle.

## Right Side

- **Active Areas editor mode:** Hides the GFX channels and makes the underlying Active Areas become editable. The Active Areas represents the physical dimensions of the screens in the video wall. The Active Areas are snap points to which the GFX channels will snap. See [Active Areas Editor](#).
- **Import Datapath configuration:** When the setup of the display controller hardware is done, the layout of the screens can be imported from the PC hosting the Datapath device. Only enabled in Active Areas editor mode.
- **Open:** Advanced Settings.
- **Live:** When *Live* is checked, all changes done to the preset and Active Areas are taken on air immediately. This is useful while adjusting and testing video wall configurations.
- **Color Active Areas:** When adjusting the Active Areas and being in *Live mode*, the purpose is to create a backdrop in the Video Wall Designer that matches the physical screens. When adjusting this backdrop (the Active Areas) it is useful to fill the area with a color. When clicked - the selected Active Area will be drawn with a color on the renderer, so the area can

be adjusted to whether it matches the physical screen. Only enabled in Active Areas editor mode. If not clicked - and being in *Live mode* the Active Areas will be filled with whatever content that is already played in the corresponding GFX channels.

- **Take Presets:** When the *Take* button is clicked, the current state of the preset, including any unsaved changes, is taken on air. This is useful while adjusting and testing video wall configurations.
- **i:** Opens the keyboard shortcuts window.

#### 4.2.4 Channel Bin

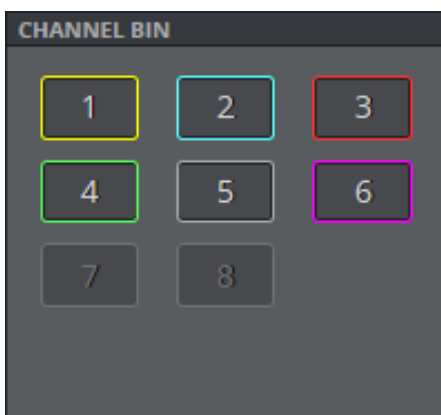

Click an item in the Channel Bin to turn it on or off in the [Channel Layout Editor](#). You can also drag channels from the Channel Bin to the video wall.

#### 4.2.5 Presets Bin



The Presets Bin lists the DynamicChannel presets which are available in the current preset group (DynamicChannels). The Preset Bin is not enabled in superchannels mode.

In the Presets Bin you can:

- **Add** or **delete** presets.
- Double click on the preset to **open** it in the editor.
- Double-click the name to **rename** it.

**Note:** If the preset or element is shown in a playlist in Viz Trio, the name given in Viz Multiplay will be shown in the *Description* column in Viz Trio.

## 4.2.6 Channel Details

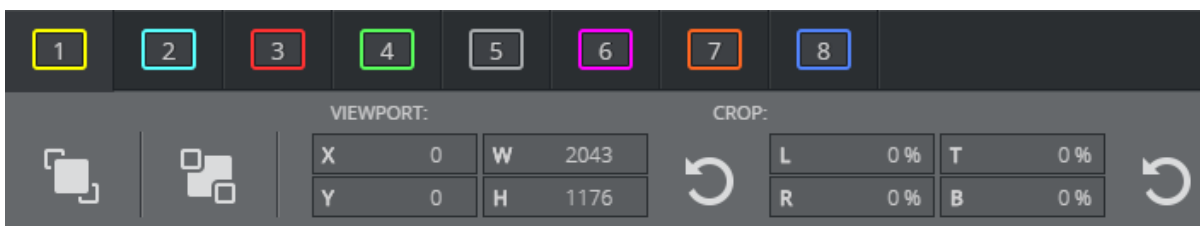

For each channel, you can modify the [Layer Order](#), [Viewport](#) and [Crop](#).

### Layer Order

- **Bring to front / Send to back:** Move the selected channel to the front or back. This changes the order in which items are layered, from front to back. Each channel is drawn on its own layer, which means all channels are independent and can be moved on top of, or behind, other channels.

A dashed line indicates that a part of the channel is behind another channel.



- **Change layer order by dragging the channels:** The left most channel box will appear on top. Drag the channel box to reorder the Z-order of the channels.

### Viewport

Position of the channel frame relative to the video wall. Either type inside the text boxes, or drag your mouse to change the values.

- **X/Y:** Position of channel's top-left corner given in the wall coordinates specified in the Video Wall Dialog. These coordinates can be pixels.
- **W/H:** Width/height of the channel's frame given in the wall coordinates specified in the Video Wall Dialog. These coordinates can be pixels.
- **Reset:** Resets the Viewport values to relocate the channel to the first Active Area of the video wall.

- ✓ **Tip:** When a GFX channel should not be visible - do not hide them by making them invisible. Instead, shrink the size to 0 (zero) and/or place them outside the visible video wall. The Viz Engine performance can be better when all channels are visible. All channels should be colored in the Channel Bin.

## Crop

Position of the content of the channel relative to the content size. With this control you can perform cropping, shifting and zooming. Any part of the frame which is not filled with content will be transparent. Alternatively, use the [Crop Editor](#) to make these changes.

The **Crop values** in the channel tabs control the cropping. Either type inside the text boxes, or drag your mouse to change the values.

- **Left %/Right %:** Position of channel content's left/right border, relative to the channel frame (positive values push content outside the frame, negative values bring the content inside the frame).
- **Top %/Bottom %:** Position of channel content's top/bottom border, relative to the channel frame.
- **Reset:** Resets the Crop values to (0,0,0,0), so that the content fills the frame.

- ✓ **Tip:** Adjust the **Snapping** and **Keep aspect ratio** settings in order to achieve the precise crop you require.

### Example

In this case, the user has set the crop values in order to shift the entire content to the left by 10%, and zoom in by 5%.

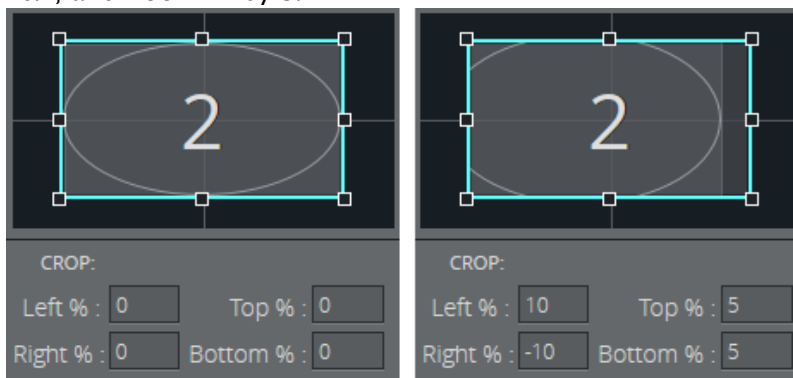

## 4.2.7 Channel Layout Editor

Use the Channel Layout Editor to arrange and resize the channels on your video wall.

- ⚠ **Note:** Hold **SHIFT** down when resizing the viewports to **scale from center**.



Each channel is drawn on its own layer, which means all channels are independent and can be moved on top of other channels.

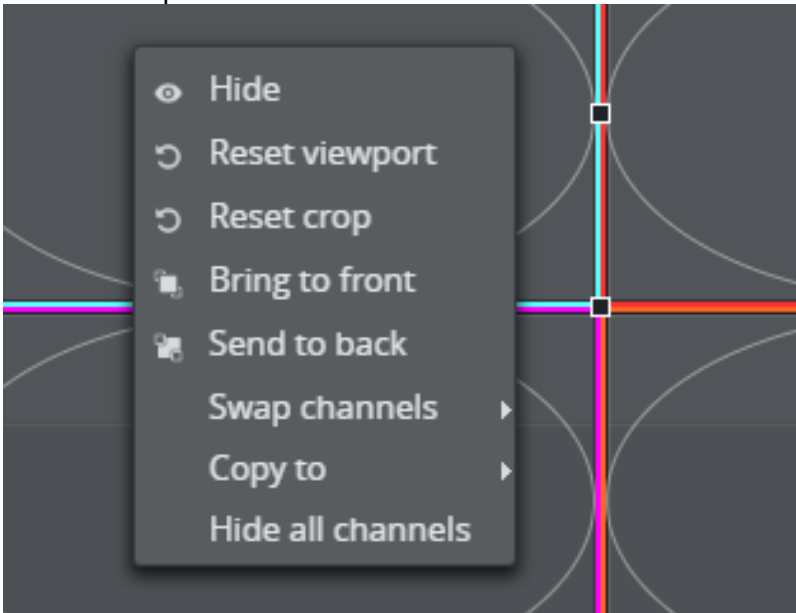

## Context Menu

Right-click a channel to access the context menu:

- **Hide:** Hide this channel from the video wall. To show it again, choose it in the [Channel Bin](#), either by clicking it or dragging it from the Channel Bin onto the video wall surface.
- **Reset viewport:** Reset [Viewport](#) to the first Active Area.
- **Reset crop:** Reset [Crop](#) to (0, 0, 0, 0).
- **Bring to front:** Put this channel in front of the other channels. See [Layer Order](#).
- **Send to back:** Send this channel behind the other channels. See [Layer Order](#).
- **Swap channels:** Select another channel with which to swap all [Viewport](#) and [Crop](#) values.
- **Copy to:** Copies the size and crop values from the channel that was clicked into the channel selected on the context sub menu.
- **Hide All Channels:** Hide all GFX channels.

## Crop Editor

Double-click a channel frame to allow dragging and resizing the channel content, relative to the frame. In this mode, aspect ratio is forced on. Press ESC, or double-click the channel, to exit this mode. Any part of the frame which is not filled with content will be transparent. Alternatively, use the [Crop](#) values in the channel tabs to make these changes.

### Example

In the image below, the user has double-clicked Channel 1 to enter edit mode. They have dragged the handle (left-hand image) and then pressed ESC to see the final result (right-hand image).

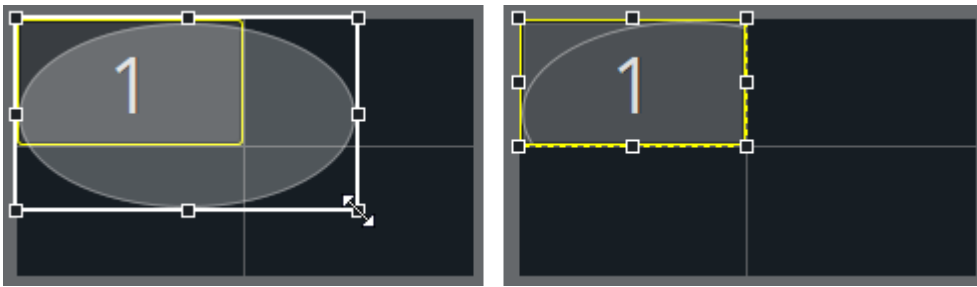

### Animation Between Presets

You can move channels outside the visible area of the video wall area, by dragging them or setting the Viewport values. This allows interesting in/out animations to be made when switching between presets.

#### Example 1

When switching from *Preset\_A* to *Preset\_B* (see diagrams below), channels 2, 3 and 4 become smaller and sweep to the right, off screen, and channel 1 stretches to fill the whole video wall.

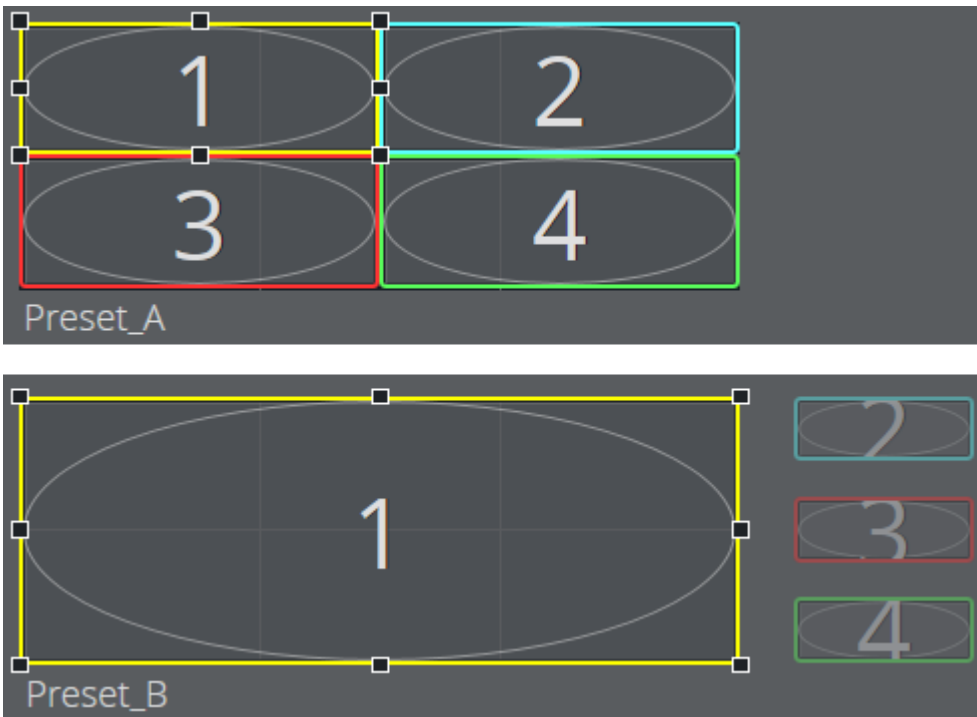

#### Example 2

Animate a channel so that it shrinks into nothing by using the [Viewport](#) settings to set the channel frame width and height to (0, 0).

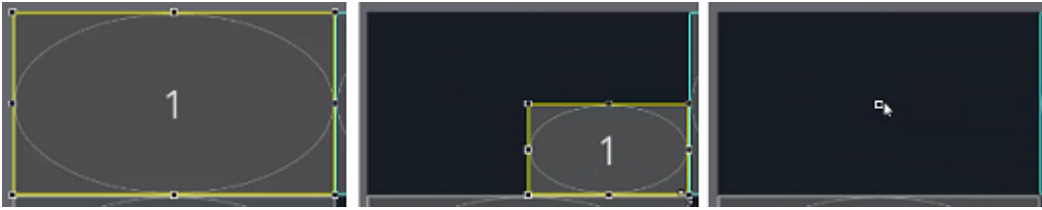

### Example 3

Control the order of the items using the layering of the channels relative to one another. Either right-click a channel frame and select Send to back/Bring to front, or select a channel frame and use the Layer Order buttons.

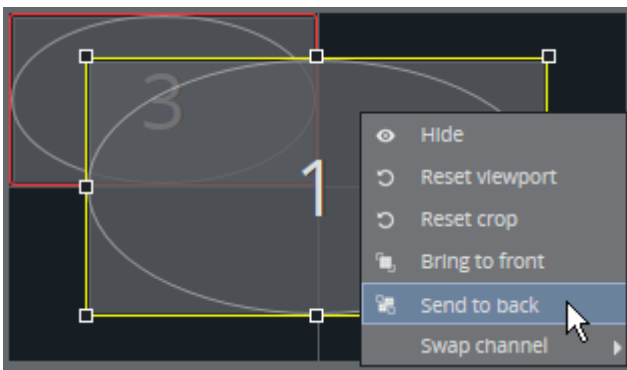

## 4.2.8 Active Areas Editor

In Active Areas mode, the backdrop of the video wall layout can be edited. These areas work as snap points for the GFX channels. They make it easier to create precise GFX channel layouts (presets). The backdrop represents the active areas on the video wall - for instance separate physical screens. When designing a preset, it can be useful to use the active areas to indicate where in the physical world the pixels are located. The Viz Engine draws its output on one surface - but through the use of NVidia Mosaic or the Datapath Fx4 display controller - the pixels from the renderer surface can be mapped to active areas on physical screens.

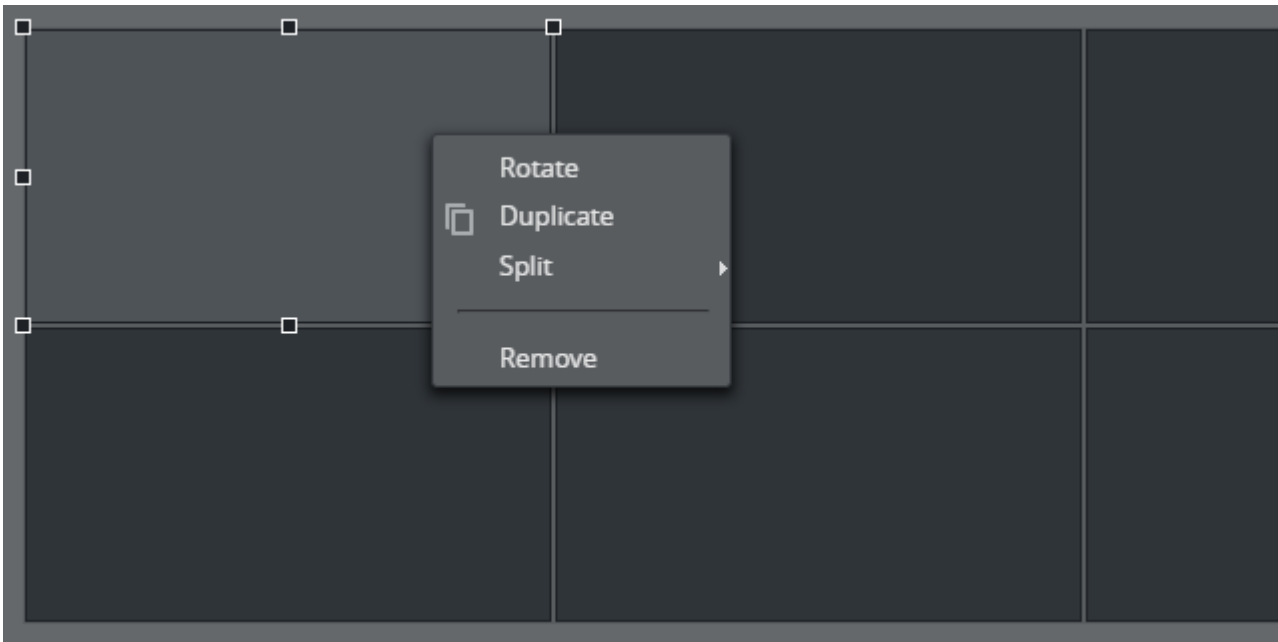

Active Areas in this editor can be created in either of three ways:

1. **Imported from a Datapath Fx4 configuration file.** When using one or more Datapath Fx4 devices, the wall layout from these boxes can be imported into the editor. The backdrop will then have the same layout as the configured layout in the boxes.
2. **Auto generated** based on rows, columns and screen size in the Video Wall dialog. When adding a new video wall in Profile Configuration, it is possible to specify the screen size (normally the resolution), and rows and columns of the screens. This info is used to auto generate a backdrop.
3. **Created from scratch** in the editor. Clear existing areas and start by clicking the plus button down to the right of the editor:

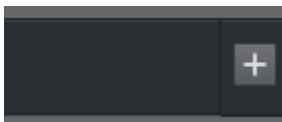

When right-clicking an Active Area, the context menu contains:

- **Rotate:** Rotates the active area 90 degrees. Free rotation is not supported. The content on the wall is not rotated. Only the aspect is changed.
- **Duplicate:** Duplicate the active area.
- **Split:** Split the active area into 2 or 4 new areas.
- **Remove:** Removes the active area.

✓ **Tip:**

- Use the live function to play out either the existing content of the corresponding GFX channel in the Active Areas - or a fill color. This is useful when a part of the renderer output should be mapped to a physical screen.
- Use the arrow keys to fine tune a position.

Active areas can be grouped by clicking and CTRL+ clicking areas, and right-clicking on one of the areas:

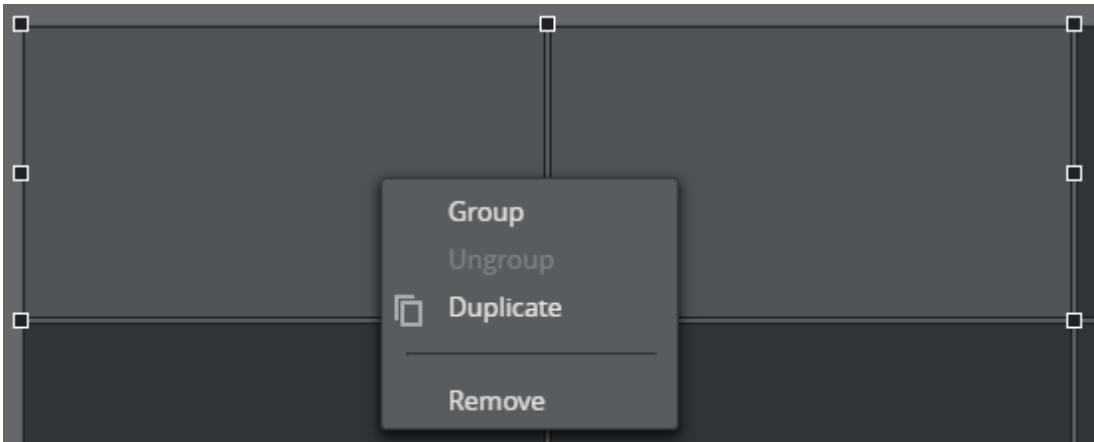

Create a group of the selected areas. The areas can be moved, resized and deleted as one unit. The group number is located at the bottom of the editor:



The highlighted numbers indicate whether a group or an individual Active Area is selected. To toggle between individual selection and group selection - click the active area. Keep an eye on the highlighted numbers and the selection markers around the active areas to see whether the selection contains a group or an Active Area.

 **Tip:** It is possible to undo and redo operations in Active Areas mode. The configuration is saved automatically.

## 4.3 Importing Graphics

In a Vizrt system, graphics are created in Viz Artist and saved as scenes. The scenes are stored in Viz Graphic Hub. The scenes can contain control fields that the scene designer decides to expose to the user which contain default values. This is the general process for playing out a scene with custom control field data (for example, specifying a name and picture on a nameplate):

- In a control client (for example Viz Trio, Viz Pilot or Viz Multiplay) the user must browse to a scene in Viz Graphic Hub and *import* it.
- The control client stores its own representation of the graphical scene in its backend (in a Viz Pilot Database or in the Media Sequencer). They are stored as *templates*.
- In a daily context, a user opens the control client, selects a template, fills in custom data in the control fields and stores a specific instance of the template as an *element*.
- The element can then be played out on a Viz Engine as a part of a broadcast. For instance, overlay graphics with the name and title of a person being interviewed.

### 4.3.1 Three Ways of Accessing Graphics in Viz Multiplay

1. Import graphics directly into Viz Multiplay. See [Basic Scene Import](#) below.
2. Use Viz Trio to import scenes and create pages usable within Viz Multiplay. See [Working with graphics](#).
3. Use a Viz Pilot system and access the graphics via templates and elements in the [Templates tab](#).

### 4.3.2 Basic Scene Import

In Viz Multiplay, it is possible to do basic scene import from the Graphic Hub directly into the GFX source tab or the Shortcuts tab or directly into any channel. To import a scene into the GFX source tab:

- Create a new group.
- Click the **Import graphics** button 
- In non-empty groups, right-click anywhere in the group and select **Import graphics** to start the import process:



The import window now appears. This window contains all the scenes created in Viz Artist. Search for the scene with free text and click **OK**.

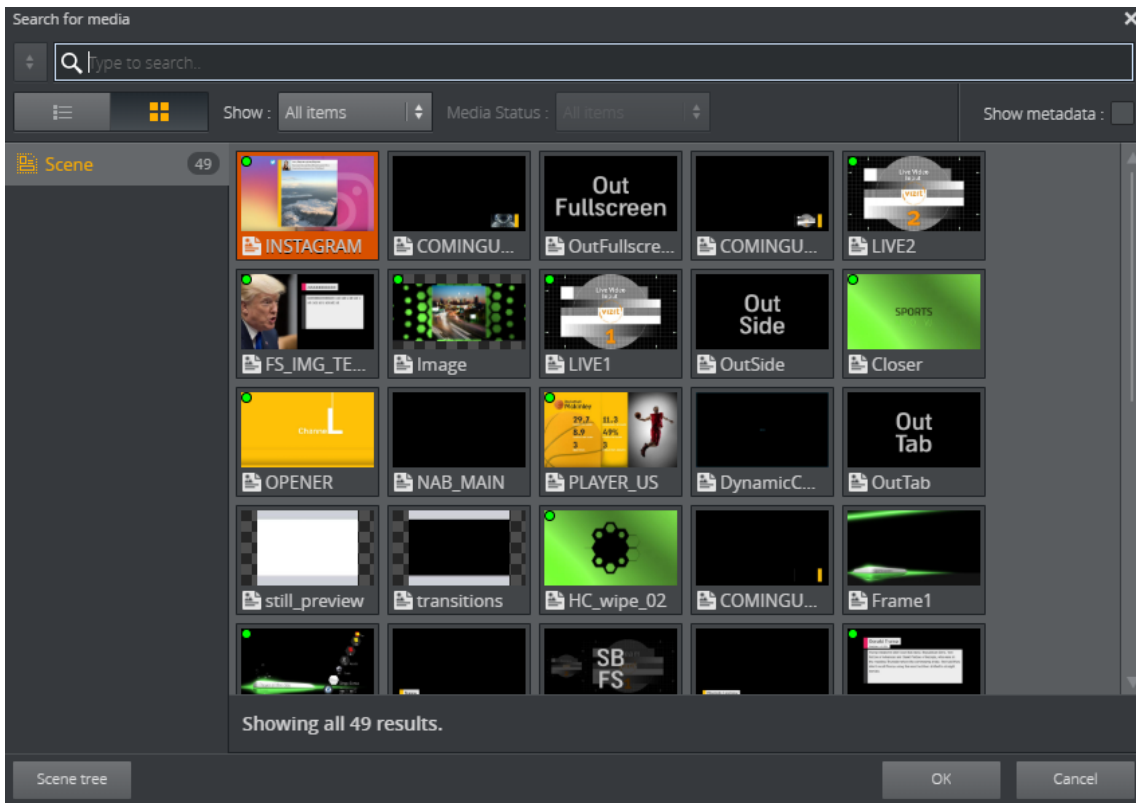

It is also possible to browse the scene tree in Viz Graphic Hub. Click the **Scene tree** button to switch to the scene browser:

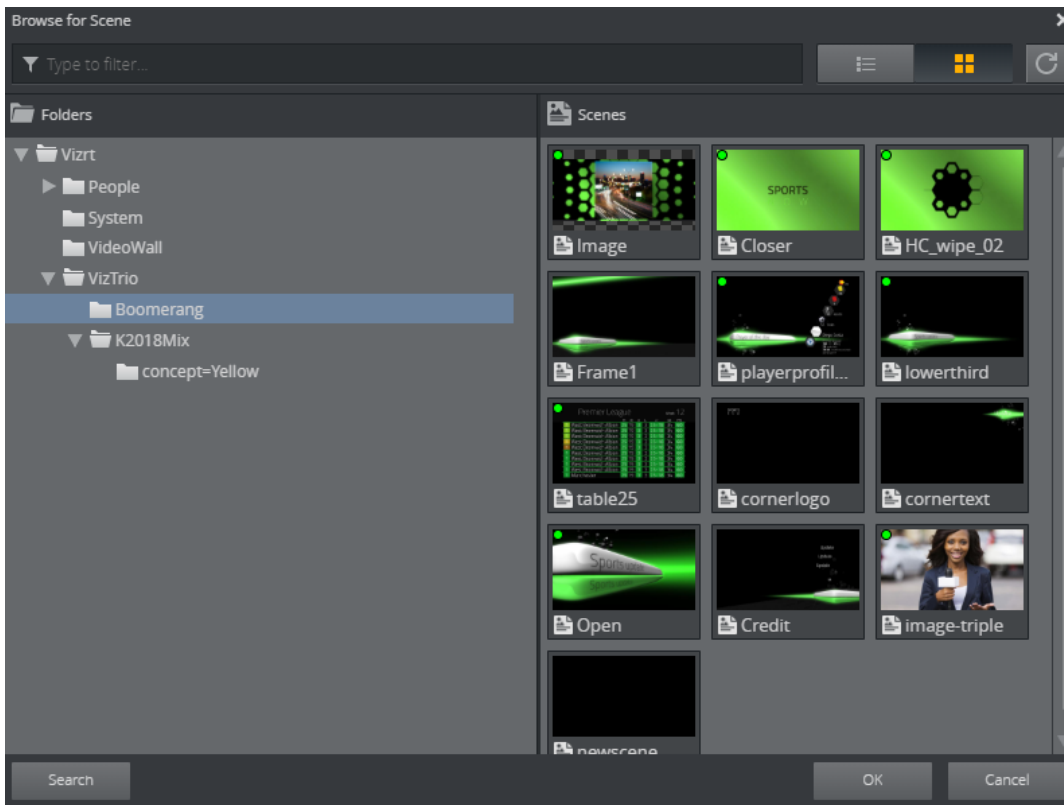

Click **Search** to switch back to the search window again.

Scenes that are already imported into the currently opened show are marked with a green dot:

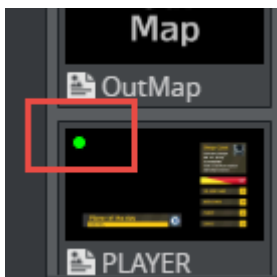

Importing a scene with a green dot will create a new instance of the template in Viz Multiplay. For instance, you may want several instances of this scene available in the GFX source tab with different default data. A good example is importing a nameplate graphic several times, and editing the different templates to contain names that are frequently used:



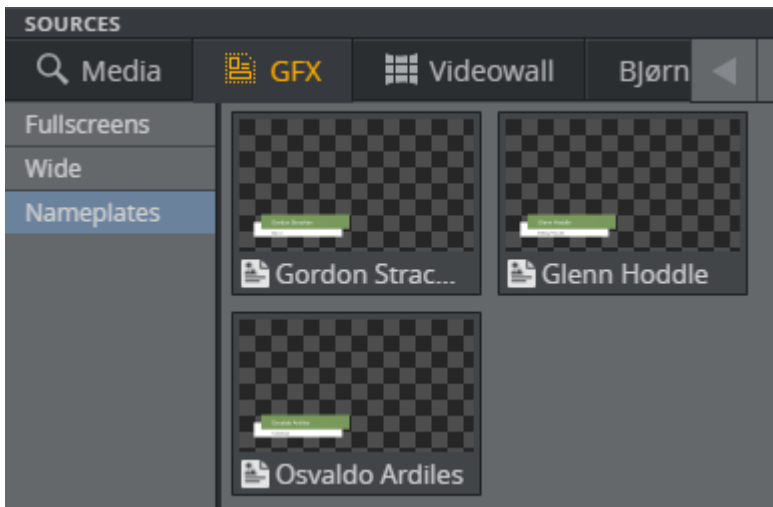

## Reimporting Graphics

If the scene designer changes the scene, for instance by adding or removing a control field, the scene must be re-imported. This can be done by right-clicking any instance of the scene in the GUI (in a channel, in the Shortcuts panel or in the GFX source tab) and selecting **Reimport**:

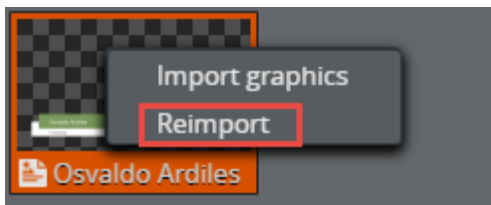

The result is that the scene is re-imported from Graphic Hub, and all elements based on this scene are now changed. The change is visible when editing the element in the Fill in form for graphics. If a control field is added, the elements based on the re-imported scene will contain default data specified by the scene designer in Viz Artist.

## 4.4 Setting Up And Organizing Content

This section covers how to import graphics and set up servers to fill Viz Multiplay with content ready to be played out on the video wall:

- [Using Custom Thumbnails for Media Elements](#)
- [Setting Up a Preview Server](#)
- [Working With Shows and Profiles](#)
- [Shortcuts](#)
- [Working with Graphics](#)
- [Inboxes](#)
- [Working with Images and Videos](#)
- [Edit Graphics, Videos and Images](#)

### 4.4.1 Using Custom Thumbnails for Media Elements

All media elements (images, graphics, clips), can have their own custom thumbnail. This is useful for elements that are used often or have a special significance to the operator, or if the thumbnail generated by default is not adequate.

Assigning a New Thumbnail to Media Elements:

1. Right click any media element.
2. Select **Set thumbnail**.
3. Upload a new thumbnail from file, or
4. Enter a URL to a thumbnail, or
5. Revert to the default thumbnail.

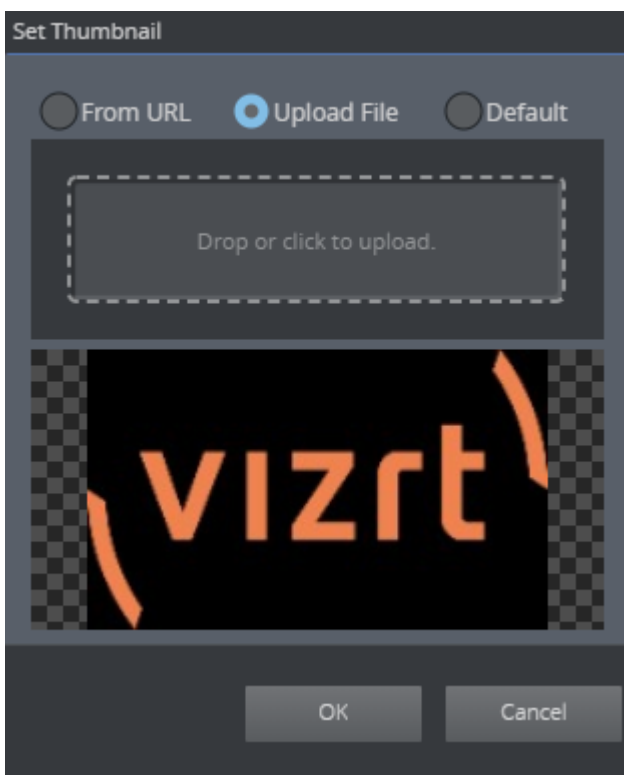

### 4.4.2 Setting Up a Preview Server

The Viz Multiplay GUI contains thumbnails for video clips, images, graphics and other elements.

Video clip and image thumbnails are fetched from the asset management system; graphics thumbnails are generated on the fly by Preview Server, which ensures that the thumbnails contain the actual element data:

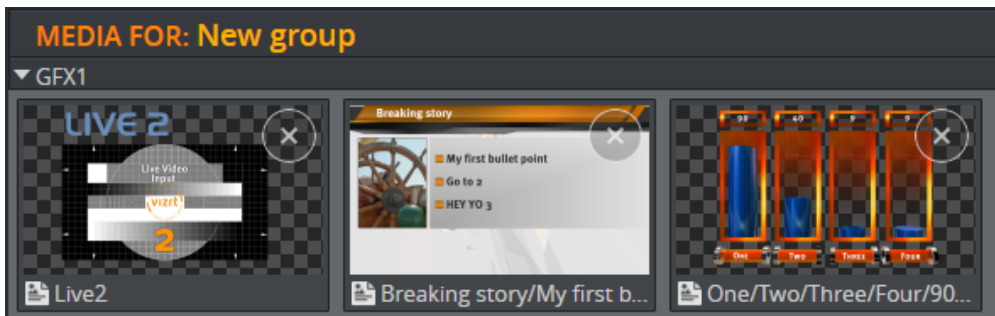

**Note:** Graphics thumbnails remain blacked out if no Preview Server is configured.

**Tip:** Viz Multiplay uses the Preview Server configuration in Media Sequencer. No actions need to be taken in Viz Multiplay if you are using Media Sequencer with a pre-configured Preview Server.

### Running Preview Server

A separate Viz Engine in VGA mode is required to run Preview Server.

**Note:** If a Viz Engine is used to generate snapshots for Preview Server, it cannot simultaneously perform other tasks such as running Viz Trio or Viz Artist.

1. Once a Preview Server is up and running, click **Settings > Servers**.
2. Enter the hostname of the Preview Server in the input field:

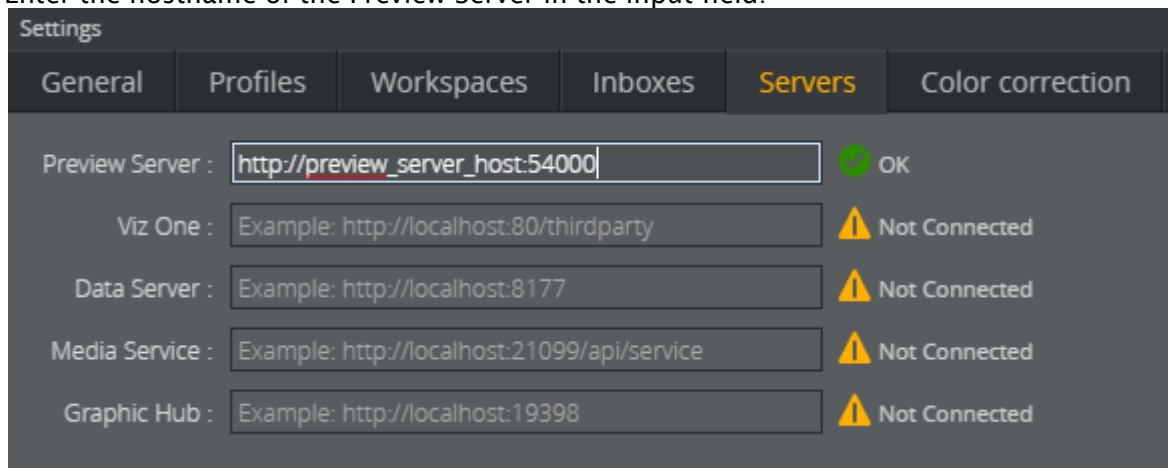

3. Press the **TAB** key. Viz Multiplay will fill out the rest of the URL.
4. Click **OK**.
5. The thumbnails will now appear on the GUI if you have graphics in your show or playlist.

✓ **Tip:** Viz Engine normally generates snapshots requested by Preview Server very quickly. However, it may take a few seconds before the thumbnails appear if your show or playlist contains a large number of elements. The HUI will refresh more quickly once thumbnails are cached in Preview Server or the web browser.

✓ **Tip:** Bear in mind that the Preview Server is connected to one or more Viz Engines that are connected to one Graphic Hub database with the scenes and resources. When importing graphics from different sources like Viz Trio or Viz Pilot Data Server, the scenes used in these graphics must be stored on the Graphic Hub used in the Preview Server. It's best to have only one Graphic Hub on the system that contains all your graphics.

### 4.4.3 Working With Shows and Profiles

Creating shows and profiles involves the following steps:

- [Create a New Show](#)
- [Create a Profile](#)
- [Create Playout Channels in the Profile](#)
- [Activate the Profile](#)

#### Creating a New Show

The first step is to create a new show.

1. Click the **New** button:



2. Give the new show a name.
3. Click **OK**.

⚠ **Note:** The show structure in Viz Multiplay is compatible with a Viz Trio show.

The **Show Pane** now has one tab with a **Page List**:

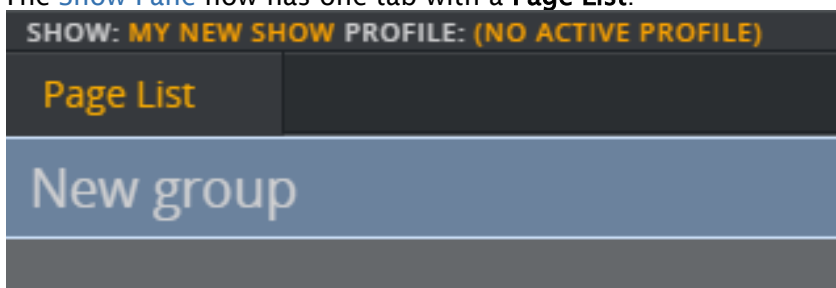

**Page List** displays the content of the page list in the Viz Trio show. Create additional playlists as required.

## Differences between Viz Trio and Viz Multiplay Page Lists

- In Viz Trio, the page list is mostly used to host pages with unique callup codes, while in Viz Multiplay the page list is a free structure that can contain any type of element with any name.
- Viz Trio displays the page list and playlists as a tree, while Viz Multiplay organizes the playlist per channel. For instance, all elements in a group assigned to GFX2 are placed in the row representing GFX2 in the GUI in Viz Multiplay. You must therefore create and activate a profile for your show in Viz Multiplay containing the channels Viz Multiplay needs to organize the elements.
- Viz Multiplay does not display any playlist or page list elements in the root group. All elements must be placed in groups to appear in the GUI.

## Creating a Profile

A profile with Output channels is required. Viz Multiplay creates one row for each channel in the GUI. The profiles you create in Viz Multiplay are compatible with any Media Sequencer client that uses profiles, such as Viz Pilot or Viz Trio.

1. Click **Settings > Profiles**.
2. Create a new profile by clicking the **Add (+)** button at the bottom of the Profiles list.
3. Enter the name of the new profile.

## Creating Playout Channels in the Profile

There are two ways to create playout channels in the profile:

1. **Create channels manually (usually for a non video wall scenario):** Add Viz Engines and Video Engines in the window to the right in the Profile Configuration. Next, create channels in the window in the middle and drag engines over to the channels. A single channel can contain multiple Engines.
2. **Create a video wall:** Channels and engines are created automatically.

## Activating the Profile

You must activate the profile for a show in order to view the output channels in the GUI. Once activated, Media Sequencer actively takes control over the show resources, monitoring and transferring clips and scene resources to the Viz Engine.

 **Note:** Since activation can be a demanding operation for Media Sequencer if a show contains many assets, it is recommended to activate the profile before the show starts and deactivate it after the show has ended.

1. Go to **Settings > Profiles**.

- Click the **Activate** button for your profile.

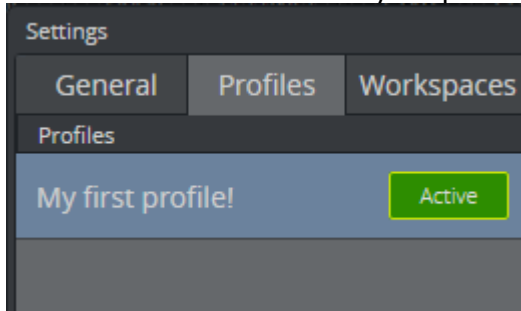

**⚠ Note:** Since activating a profile is a Media Sequencer operation, your show will be activated for all clients who have the show open. Your show can only be active in one profile.

#### 4.4.4 Shortcuts

When a new show is created, Viz Multiplay generates a special playlist called **shortcuts**. The shortcuts playlist is a regular playlist with groups and elements.

If desired, you can select a different playlist to be the shortcuts playlist under **Settings > General**. Select a playlist from the **Shortcuts** dropdown:

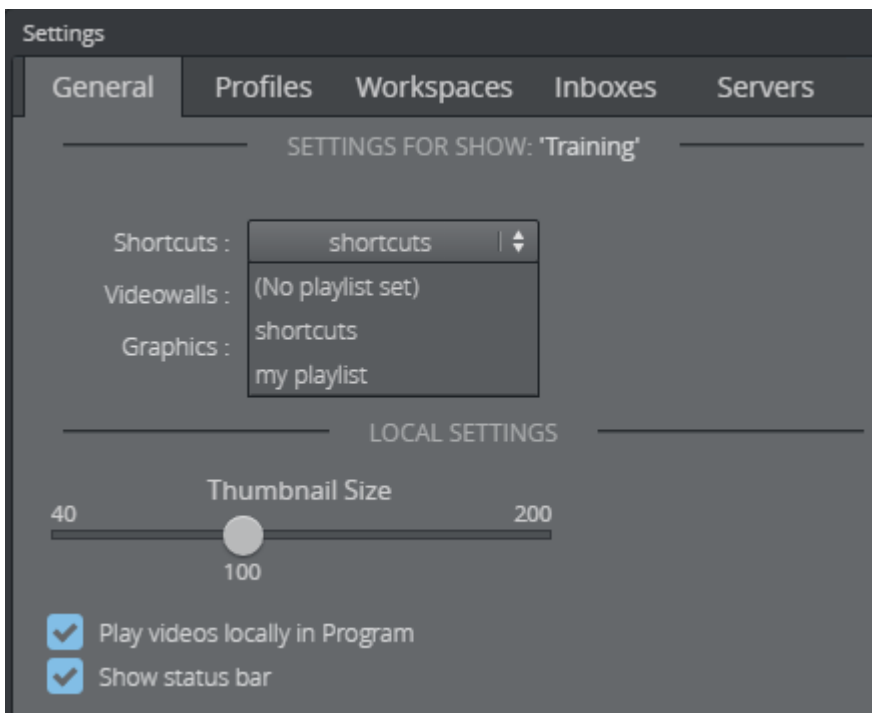

The shortcuts playlist appears in the [Using the Shortcuts Bar](#). Each tab is a group in the playlist.

Create a new group in Viz Trio or click **Settings > General** and remove it as the shortcuts playlist. Select **(No playlist set)** as the value in the **Shortcuts** dropdown. It now becomes a regular playlist in Viz Multiplay, where you can add or remove groups.

Unlike other channel groups in Viz Multiplay, playlists in the Shortcuts bar are not assigned to a specific channel. Elements in the shortcuts bar play out on the channel assigned for each element. This means that if you drag an element from the GFX playlist directly to the Shortcuts bar, the element will keep its assigned channel. If the element has no assigned channel, it will play out on the Program channel in the profile.

✔ **Tip:** The Shortcuts bar normally contains the video wall presets, “filled” video walls (presets with content) and backgrounds. These should be played out on the main channel of the video wall using the defaults from Viz Multiplay. The main channel is called **A**. Right-click elements on the Shortcuts bar to ensure that they have the correct playout channel.

## 4.4.5 Working with Graphics

Import graphics from Graphic Hub.

### Basic Scene Import

For basic scene import (without support for Transition Logic) - use the Import scene function directly in Viz Multiplay to import graphics created in Viz Artist. Right-click anywhere and select **Import graphics**:

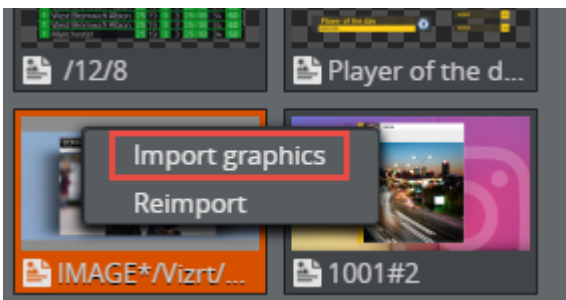

### Importing Scenes with Viz Trio

Graphics can be imported into Viz Multiplay using Viz Trio. This is handy if you need to import Transition Logic scenes or already have a graphics system running with Viz Trio. In Viz Trio:

1. Select **Import Scenes** in the Page Editor menu.

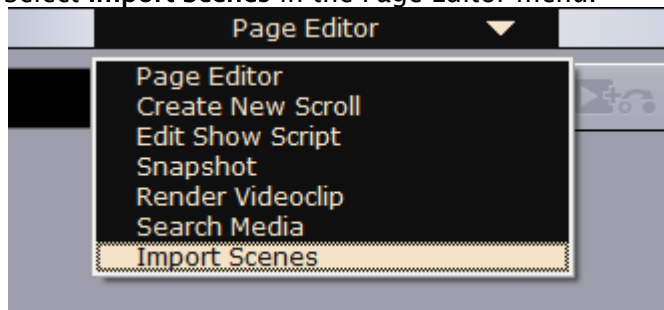

2. Browse the scene tree in Graphic Hub and import the scenes you want to use.

**Note:** You now have one template per scene you imported. These are not visible in Viz Multiplay.

3. Create a page for each of the templates.

**Note:** These pages end up on the root level of the page list in Viz Trio and are not visible in Viz Multiplay. To make them visible, move the pages into groups.

## 4.4.6 Inboxes

Inboxes are global shows that are always available in the Sources pane. They can contain any type of element (images, clips and graphics), and the content does not need be placed in groups.

### Inboxes are Typically Used

- For a special show that is a target for Sequencer Ingest. New ingested material then appears automatically in the inbox, ready to be used in Viz Multiplay.
- For listing available live source elements. These can be dragged to any group channel in Viz Multiplay and played out.
- For graphics created during a broadcast or event that are imported by a Viz Trio operator into the inbox show. The graphics are then instantly available in Viz Multiplay.

### Using a Show as an Inbox

1. Click **Settings > Inboxes**.
2. Create a new show or select an existing show.



3. Drag the show over to the **Inboxes** list to the right.

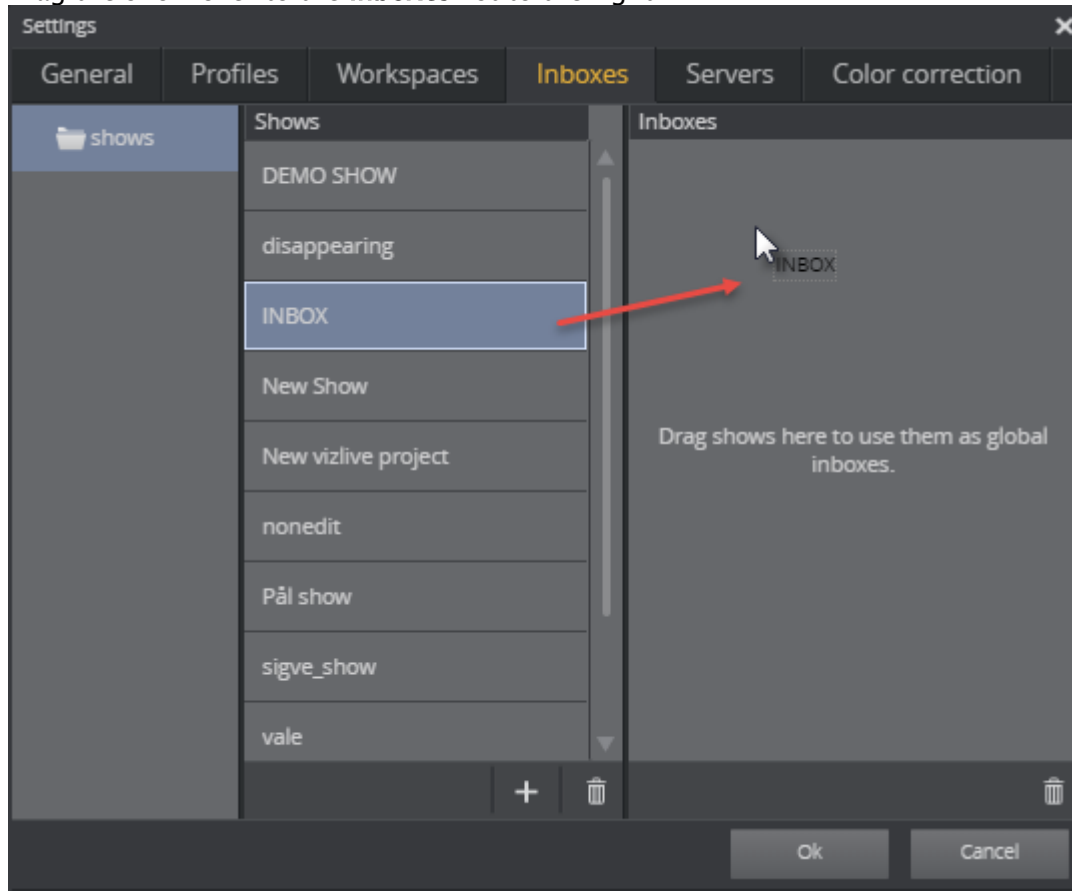

4. The show now appears in the Sources pane:

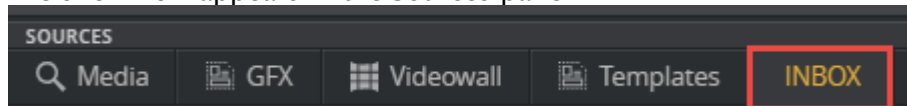

#### 4.4.7 Working with Images and Videos

**Note:** A MAM system such as Media Service, Viz One or a Graphic Hub REST service (images only) is required in order for Viz Multiplay to access media assets.

Once a MAM system is up and running:

1. Go to **Settings > Servers**.
2. Enter a hostname in the input field for the service.
3. Press TAB, and Viz Multiplay will fill out the full URL.

4. Click **OK**. The **Media Tab** in the Sources pane now contains your MAM system as a search provider.

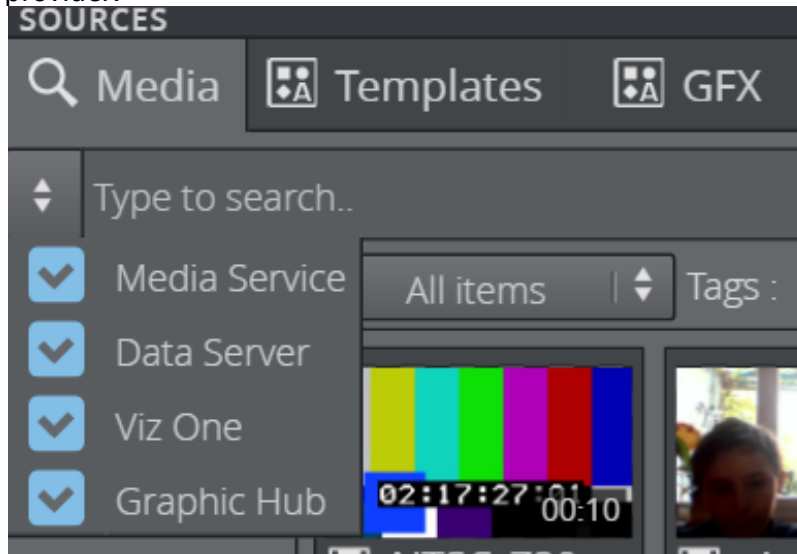

**Note:** Videos in Viz Multiplay are limited to the broadcast formats and aspects supported by the clip channels in Viz Engine.

## Setting Asset Storage

The Viz One setting is global for Media Sequencer. When asset storage is configured, the Media Sequencer starts to monitor shows and playlists and transfer assets to the Viz Engines.

**Note:** If you have a Viz One system, you also need to set Asset Storage in the video wall dialog box by clicking **Settings > Profiles** and double-clicking the video wall in the selected profile.

**Note:** If you don't have video walls, the Asset Storage must be set for each Viz Engine and Video Engine in the list to the right. Failure to do so will result in videos not being transferred to the Viz Engine.

## Configuring Media Service by Entering the Hostname in Media Service

1. Click **Settings > Servers**.
2. Enter the Media Service URL (or hostname) in the Media Service input field.

This setting is only visible to Viz Multiplay and is not shared with Media Sequencer, which will not register asset storage as configured. Since Media Service is designed to host its clips on the clip root of the Viz Engine, clips do not need to be transferred and it is therefore not necessary for asset storage to be registered by Media Sequencer. However, since error messages may appear from MSE and in Viz Trio, another way of configuring Media Service is outlined below:

## Configuring Media Service by Entering the Hostname in the Viz One Input Field

1. Click **Settings > Servers**.
2. Enter the Media Service URL (in addition to the hostname) in the Viz One input field.

Media Sequencer now thinks it is communicating with a Viz One service, and Media Service uses the same API as Viz One even though no file transfers are needed. You can use this method if it is OK that the Media Sequencer is configured with Media Service. Bear in mind that this configuration is common to all Media Sequencer users.

If you use Media Service, all the Viz Engines must use the Media Service clip folder as their clip root - as a shared disk. This can affect playout performance. If you have a single Viz Engine, Media Service is well suited to run on the same computer as the Viz Engine, where they both have access to the local clip root folder.

**Note:** If you have set up a **Graphic Hub REST service** you have access to images in the Graphic Hub. The play-out performance will be best for these images as they can be pre-loaded. Images from Viz One and Media Service are loaded when they are played out, which can cause a short delay.

Configure all search providers and limit searches using the boxes in the search provider's list in the search panel:

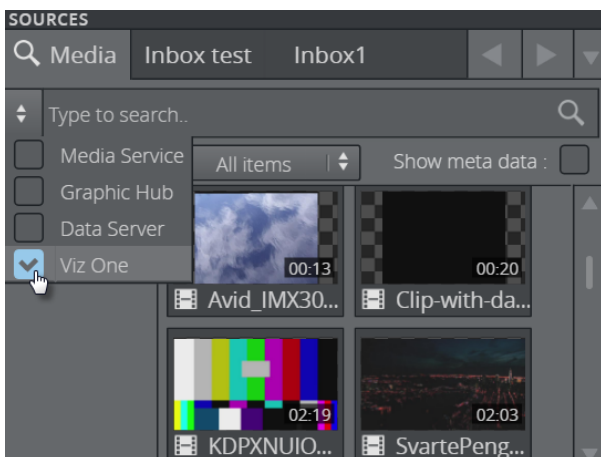

### 4.4.8 Edit Graphics, Videos and Images

If a show is prepared properly and an asset provider is set up, you can add and edit elements during a broadcast or event.

This sub-section covers the following topics:

- [Example Workflow](#)
- [Editing Elements](#)
- [Setting In and Out Points in Video Clips](#)
- [Zooming and Cropping Images](#)
- [Editing Graphics](#)

## Example Workflow

### In Viz Trio

1. Prepare a show by importing scenes from Graphic Hub into the show. These scenes become templates in the show.
2. Create pages for the most frequently used graphics and drag them into groups in the GFX playlist.
3. These pages are now available in Viz Multiplay.

### In Viz Multiplay

1. During the broadcast or event, select the page list or a playlist in the [Show Pane](#).
2. Click a group. Each group channel is now populated with the relevant elements.
3. The Viz Multiplay operator needs a new element (a video, an image or graphics) and finds it in a source (Media tab, inbox, GFX playlist, etc.) before dragging it into the channel where it will be played out.
4. The operator can now edit the element by right-clicking and selecting **Edit**.

## Editing Elements

**Caution:** Changes made to elements being edited are made in real time on the elements in the Media Sequencer for all operations. These changes are saved immediately and it is not possible to undo them.

**Tip:** Copy an element by dragging it and pressing **CTRL**.

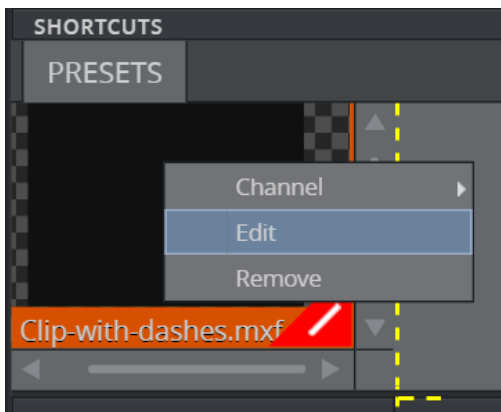

## Setting In and Out Points in Video Clips

Scrub through video clips and set new in or out points:

1. Drag a video into the channel where it will be played out.
2. Right-click the video and click **Edit**.
3. Scrub in the timeline to where you want to set an in point.

4. Click the **Set Mark In** icon or press the **i** key to set an in point.

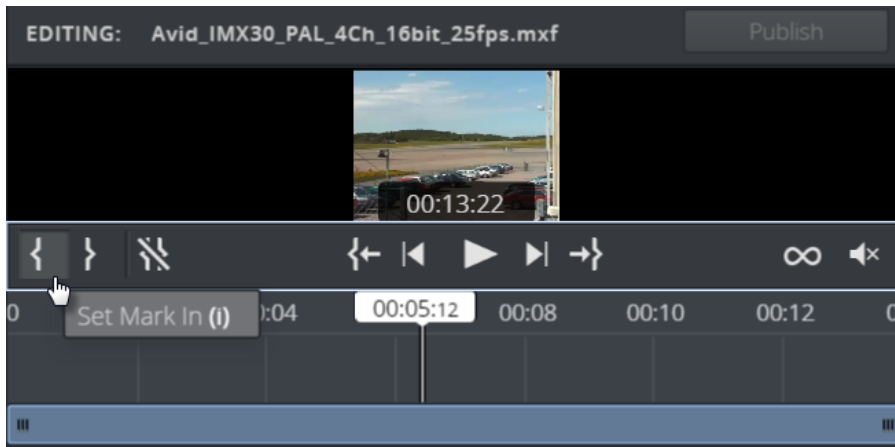

5. Click the **Set Mark Out** icon or press the **o** key to set an out point.

## Zooming and Cropping Images

Add a zoom or crop effect to images:

1. Drag an image into the channel where it will be played out.
2. Right-click the image and click **Edit**.
3. Click either **Crop** or **Animation**.

## Editing Graphics

For graphics, the operator can enter data in the fields exposed by the scene designer.



## See Also

- [Editing Videos](#)
- [Importing Graphics](#)
- [Editing Images](#)
- [Preview Server Administrator Guide](#)

## 4.5 Preparing And Playing Out Content

This section covers:

- [Preparing Content](#)
- [Cleaning and Clearing the Renderers](#)
- [Arming](#)
- [Playing Out Content](#)
- [Swapping Content between Armed and Program](#)
- [Auto-playlist](#)

### 4.5.1 Preparing Content

#### Initializing





Initializing means that the renderer will load all resources in the current show and playlists needed to play out the graphics into the memory of the Viz Engine(s), graphics will then appear instantly when taken on air. The Initialize function works the same way as it does in Viz Trio, if the graphics are not loaded, it may take some time before the renderer plays the graphics when a Take operation is executed.

It is also possible to initialize single scenes by right-clicking the thumbnail and selecting **Initialize**.

**⚠ Note:** **Initialize** loads content but does not refresh it. If changes have been made to a scene that was already loaded, a **Cleanup** renderer command must first be issued, followed by an **Initialize** command. If single scenes need to be reloaded from the Graphic Hub, right-click the thumbnail for the element and select **Reload Scene**.

#### Initializing a Show

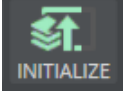
To initialize a show, click the **Initialize** button. The button shows the status and progress of the loading process:

Icon	Status
	Action needed. No scenes are loaded on the renderer. Click the button to start the process.
	Not loading. Action needed. Scenes are partly loaded on the renderer, but the loading operation is currently not active. Click the button to restart the process.
	Loading. No action needed. The scenes are partly loading, and the loading process is active. Hover your cursor over the button to view detailed progress status.
	No action needed. All scenes are loaded into the renderer.

Hovering your cursor over the **Initialize** button makes a tool tip with more detailed loading progress appear. Note that the colored progress on the **Initialize** button reflects the aggregated status for the page list and the playlists.

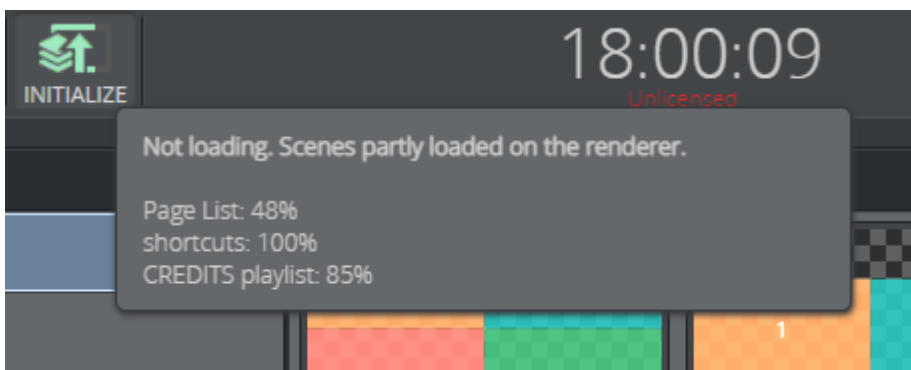

**Warning:** Initializing during a broadcast may impact the frame rate of scenes playing On Air. Initializing should be done in advance or when Off Air in order to avoid affecting the content in the renderer.

## Initializing Elements

Initialize single graphic elements and filled presets in Viz Multiplay by right-clicking the graphics and selecting **Initialize**:

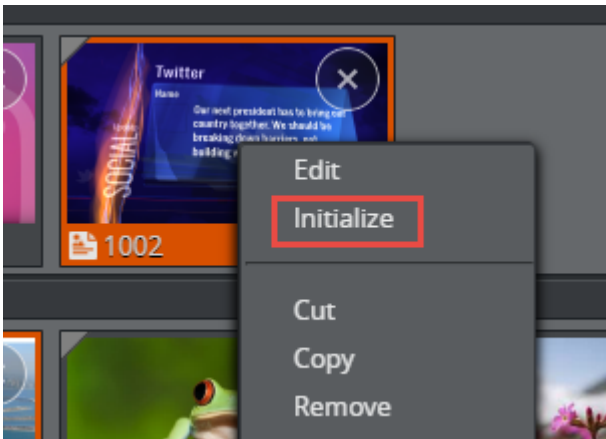

**Warning:** Initializing single elements will likely affect the frame rate on the renderer. Flickering or frame drops may occur.

### GUI Feedback

The colored symbols in the upper left corner of the elements in the Media column will indicate whether the element is not loaded (gray), partially loaded (yellow) or fully loaded (green) on the renderer.

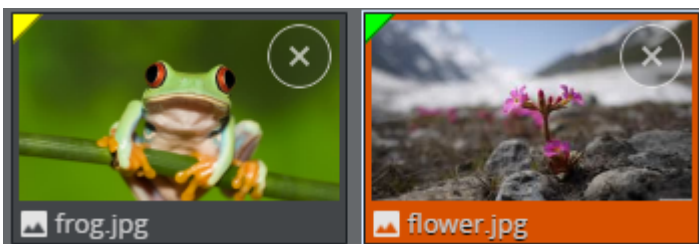

The initialized status in the Media Pane shows the loaded status for graphics. Clips may remain unavailable even if the graphics are loaded. For filled presets: although there may be a green status for the graphics, some of the clips may still be unavailable:

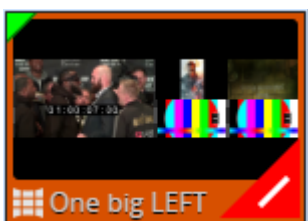

Clicking the red error mark, or hovering your cursor over it, will display detailed status on the availability of individual clips in the filled preset.



## 4.5.2 Cleaning and Clearing the Renderers

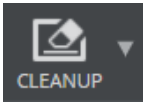

Clean up all output channels and video walls, or a particular wall or channel in a profile using the **Cleanup** button above. Cleaning up a wall unloads all the resources from the memory of the renderer, avoiding space issues and the inadvertent use of media from a previous session. Cleanup should be done before initializing a new show or in order to re-initialize the same show into the renderer's memory.

**Warning:** Cleanup also removes media for all other operators using the Media Sequencer.

- Clean up the renderer for **all** channel and walls in a profile: Click the **Cleanup** button to clean up the renderer for all walls for the currently-active profile.

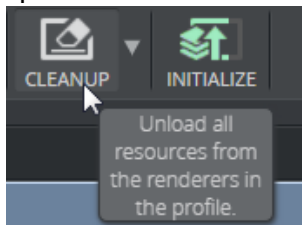

- Click **Yes** in the warning dialog that appears to clean up the renderer for **all** walls and channels in a profile.

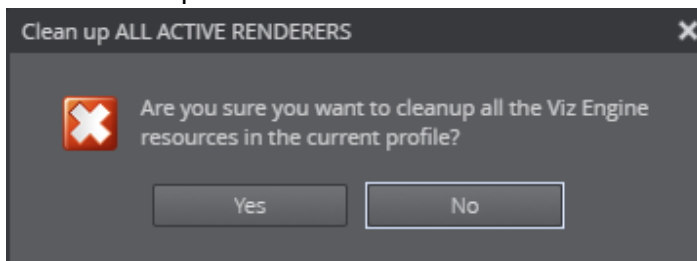

- Clean up the renderer for a particular wall in a profile: Click the **downward-facing arrow** in the cleanup button to expose a menu and select the wall you want to clean up.

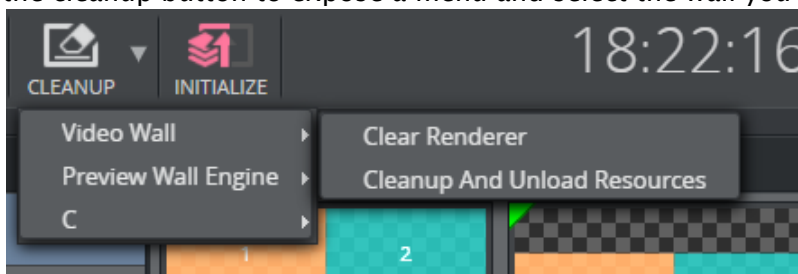

Note that each video wall and channel has a sub menu with two items:

- **Clear Renderer.** The renderer will go black, but this will not unload resources from the Viz Engine.
- **Cleanup And Unload Resources.** This will unload all resources from the Viz Engine.

### 4.5.3 Arming

You can arm elements, which means preparing them to be played on air, in Viz Multiplay. This can have somewhat different meaning for different element types and for configurations.

In Arm and Fire workflow, Viz Engine prepares and readies armed elements on an inactive sub-superchannel, and then just switches onto that when Take ("Fire") is called. With this feature set even synchronous playout is guaranteed for multiple elements within a video wall.

In legacy video wall setup only videos are prepared by the MSE, images and graphics are not pre-loaded in any explicit way.

To arm elements, disable 1-Tap mode so the Armed column becomes visible.

Armed elements are visible in all Viz Multiplay clients connected to the same MSE. A conflict will arise if two operators want to arm their own private content on the same channel, ready to be played out. In legacy setups or superchannel videowalls without Arm and Fire configuration it is possible to work around this by selecting different workspaces for the two operators. In this case armed elements will be visible per workspace, if the first operator has activated his own workspace, his armed elements are not visible to the second operator in another workspace.

### 4.5.4 Playing Out Content

There are several ways of playing out elements in the renderer. The simplest way is to click an element, which sends it to the armed column or directly on air if 1-Tap mode is enabled.

✓ **Tip:** Select elements manually from one or more groups and click **Take Selected** or **Arm Selected**. You can de-select elements by holding down the **CTRL** key.

Viz Multiplay also has another, more story-centric way of playing out elements:

1. Organize your material in groups, for example one group per story.

✓ **Tip:** Each group can have one or more elements placed in the order they will be played on air. Elements can also be assigned to the channel where they are to appear.

2. The first element in each channel will be selected when the operator clicks a group (story).
3. All the selected elements can now be played out or armed by clicking **Take Selected** or **Arm Selected**.
4. The selection now jumps to the next element in each group.
5. When this procedure is repeated, Viz Multiplay can be used as a tool for sequential playout of elements ordered in a story-centric fashion.

✓ **Tip:** There should always be a preset on air when using Viz Multiplay with video wall presets. The preset element plays out in the middle layer on the main channel of the renderer (normally host:6100). The GFX channels will not show without a preset On Air.

### 4.5.5 Swapping Content between Armed and Program

It's possible to test content that you plan to play out on the actual video wall itself. You can do this by exchanging (swapping) the content in both columns. For instance, the Multiplay operator can prepare a set of media elements in the Armed column for playout when the wall is off air. If the Extra Armed button **SWAP** has been enabled, you can test the content on the wall by clicking the **SWAP ALL** button.

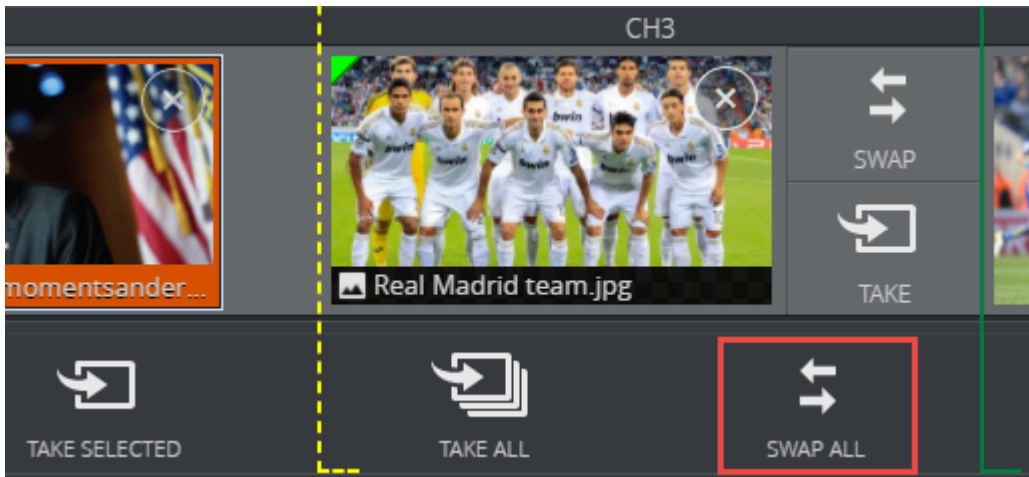

Any content currently in the Armed column will play out on the wall, while the media elements currently playing out on the wall will move to the Armed column. When the operator sees that everything is okay, a new click on the **SWAP ALL** button will toggle the content back again. The wall will then resume playing out the content from a minute ago, and the Armed column will once again contain the media elements that are ready to be played on air.

In this way, the operator can test content on the actual wall.

It is also possible to swap single elements by clicking the **SWAP** button in the Armed column:

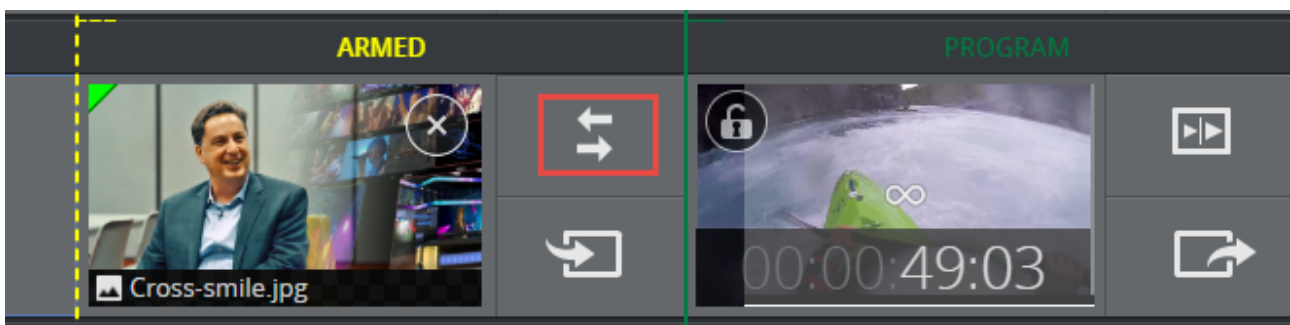

**Info:** If a channel in Armed does not contain any media elements when **SWAP ALL** is clicked, the existing content in the channel will remain on the Program engine. This ensures that the wall will never go black when **SWAP ALL** is used.

## 4.5.6 Auto-playlist

Viz Multiplay features an option to play out media elements automatically in succession. This can be handy if you have a set of media elements you want to loop on the video wall. Auto-playlists play out media elements in a specific channel, and the media elements must be a part of the same group.

**Info:** When playing out elements from an auto playlist, it is not possible to use the advanced features of the Arm and Fire workflow.

### Creating an Auto-playlist

- Create a group in a playlist where your media elements for the Auto-playlist will be placed.
- Drag media elements into this group. All media element types can be used in an Auto-playlist: Graphics, images, clips, and live sources.
- Right click each media element (or go to Off Air mode and multi-select media elements) and select **Add to Auto-playlist**:

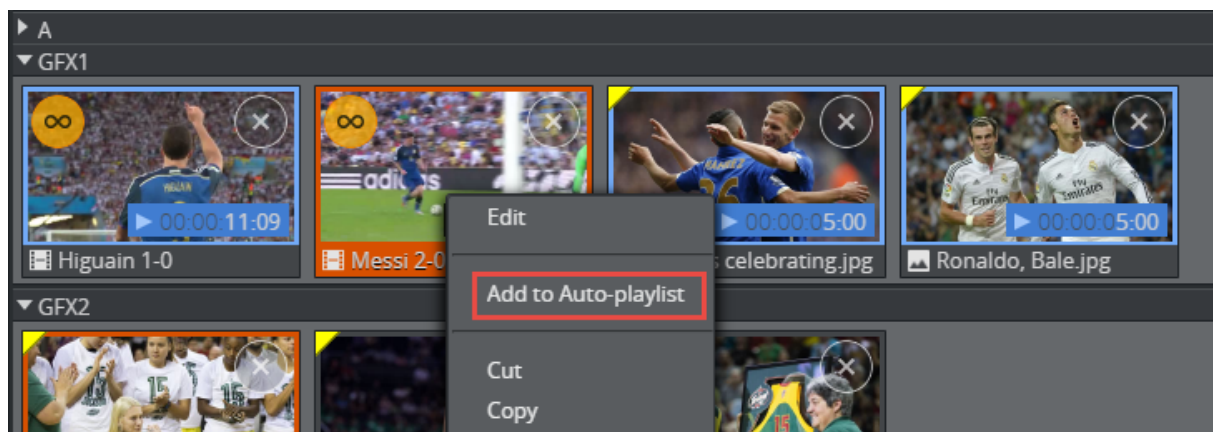

**Info:** Media elements added to an Auto-playlist have a blue duration field and a blue frame to differentiate them from regular media elements. The blue duration field shows how long the Auto-playlist element will stay in the renderer until the next element is played. The default duration for media elements is 5 seconds where no other duration has been specified.

## Editing and clearing items in an Auto-playlist

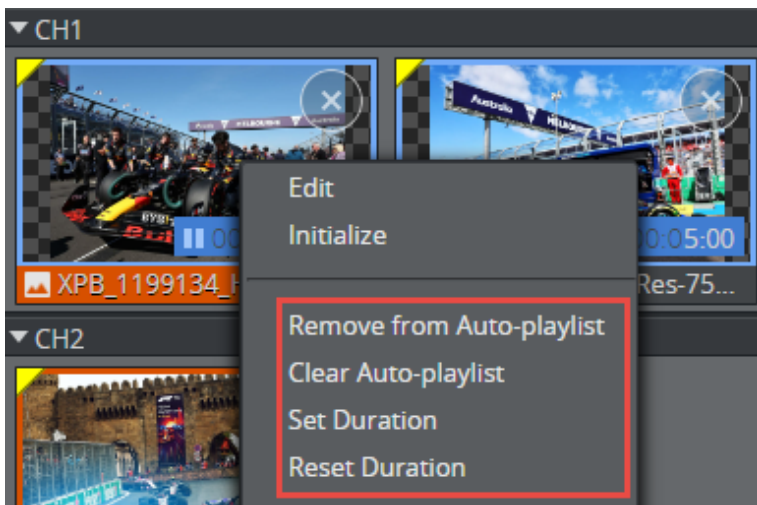

- **Remove an item** by selecting Remove from Auto-playlist on the context menu. Note that this does not delete the playlist item - it will only remove it from the Auto-playlist.
- **Remove all items** by selecting Clear Auto-playlist.
- **To set a new duration for clips in auto-playlist:** Edit the clip and set a new mark in and/or mark out. The new duration of the clip will be used as the duration in the Auto-playlist.
- **To set a custom duration for other media elements in auto-playlist:** Right click the element and select **Set Duration**. A dialog will pop up prompting you to enter a number in seconds.
- **To reset the duration back to the default duration in auto-playlist:** Right click the element and select **Reset Duration**. The default duration for clips is the actual clip length between Mark in and Mark out. For images with an image effect, the default duration is the image effect duration. Although graphics may have a specific duration (for instance, if the graphic is a continuously running animation), graphics with stop points do not have a specific duration - all media elements added to an auto-playlist have a 5 second default duration if no other duration is specified.

✓ **Tip:** It's possible to add and remove media elements while an Auto-playlist is running.

## Starting and Stopping an Auto-playlist

Once all media elements in a group have been added to the Auto-playlist, and the duration has been set on each element, you can start the Auto-playlist:

- Click one of the Auto-playlist elements. This starts the automatic playout of these elements.
- Each media element stays in the renderer for as long as the duration indicates. When the element is finished, the next element plays out.
- When the last element is finished, playout restarts from the first element.

- If a playlist contains a group with an Auto-playlist, a red blinking light at the top left indicates that it's running:

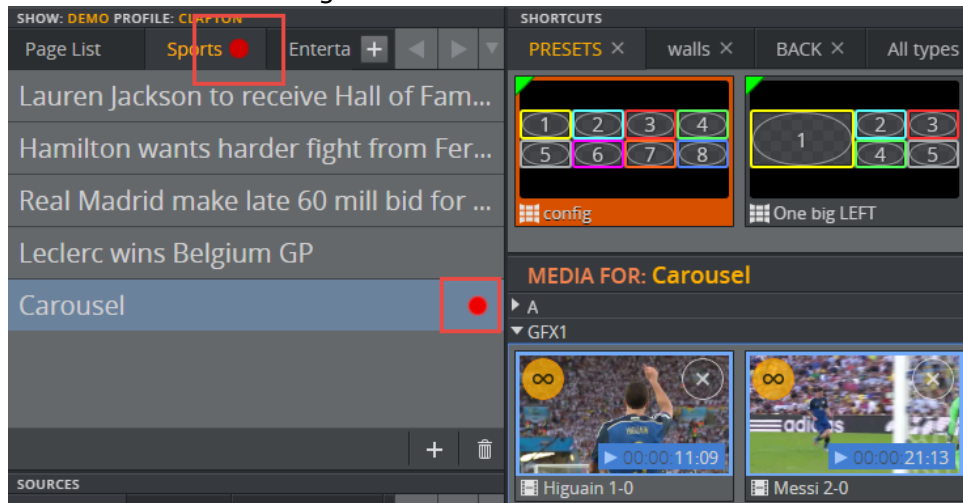

To stop an Auto-playlist, right click the Program column and select **Stop Auto-playlist**, or take the current element Out.

## 4.6 Working With Filled Presets

Presets describe the layout of the video wall regions (channels) on the video wall.

### 4.6.1 For Dynamic Walls, Presets with GFX Channels are:

- Regular graphic elements playing out the DynamicChannel scene, which keeps track of the position of GFX channels.
- Pages in a show that are not technically tied to one particular video wall configuration in a profile. Since the presets of a show will not be usable for a different video wall setup, presets created in a show should only be used together with one particular profile.

### 4.6.2 For Video Walls with Superchannels, Presets are:

- Regular playlist elements with a special master template, naming one preset in the Superchannel scene behind the master template.
- Each Superchannel video wall is represented by one Viz Artist scene, imported into Viz Multiplay as one master template.
- The Superchannel scene is imported in a profile.
- When opening a show and activating a profile, the presets must be imported into the show.
- The imported presets become invalid if a new profile is activated for the show.

**Note:** Presets can be filled with content using both workflows.

This section covers the following topics:

- [Common Workflow](#)
- [Adapt the GUI for Pre-filled Walls](#)
- [The Preset Content Editor](#)

### 4.6.3 Common Workflow

#### Sample Workflow

1. Create a new group in the shortcuts playlist.

**Note:** The shortcuts playlist already contains one group called **Presets**. You will now add an additional group for your pre-filled walls, this group will appear as a tab in the Shortcuts bar.

2. Drag a preset from the **Videowall** tab to your new group in **Shortcuts**, or the main channel (usually channel **A**).
3. Right-click the preset and select **Edit**.
4. You can drag and drop elements from the different tabs (Media, inboxes, GFX playlist) from the editor to the GFX channels in the video wall.

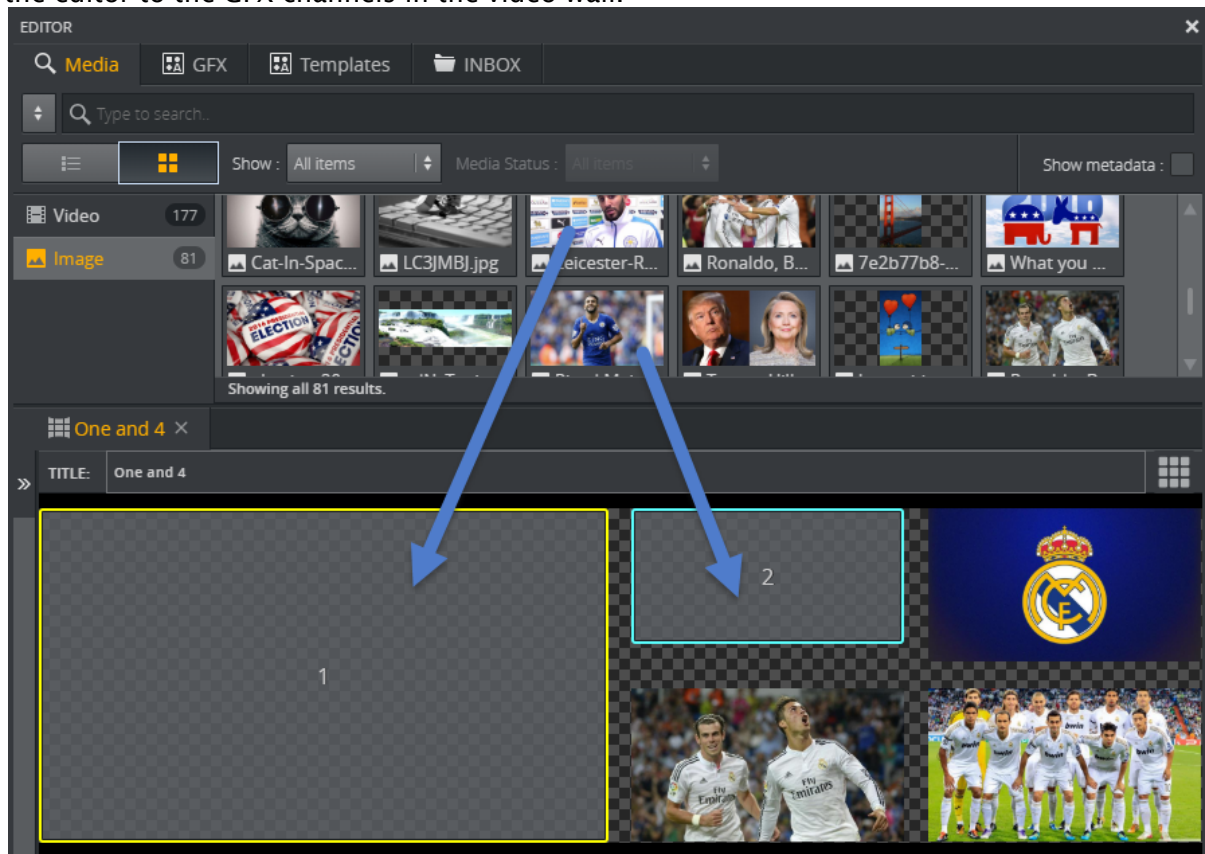

5. Edit individual elements in a video wall by clicking the **play icon**, or by right-clicking and selecting **Edit** or simply double-clicking content in a GFX area.

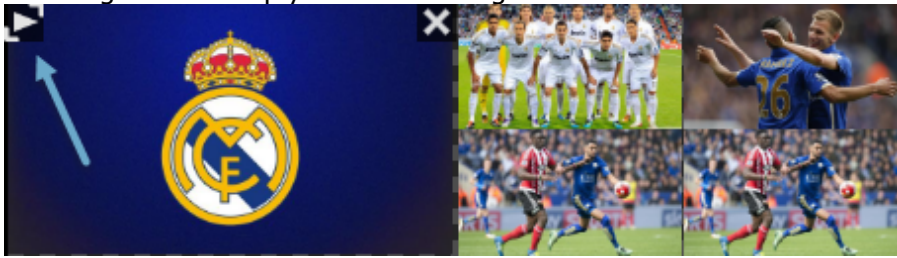

6. A GFX area may occasionally be outside the editor, or two GFX channels might partly or fully overlap. If this happens, hold **SHIFT** down to reveal the GFX channel numbers behind the content and click **Reveal** to show a secondary view where all the GFX channels are stacked out:

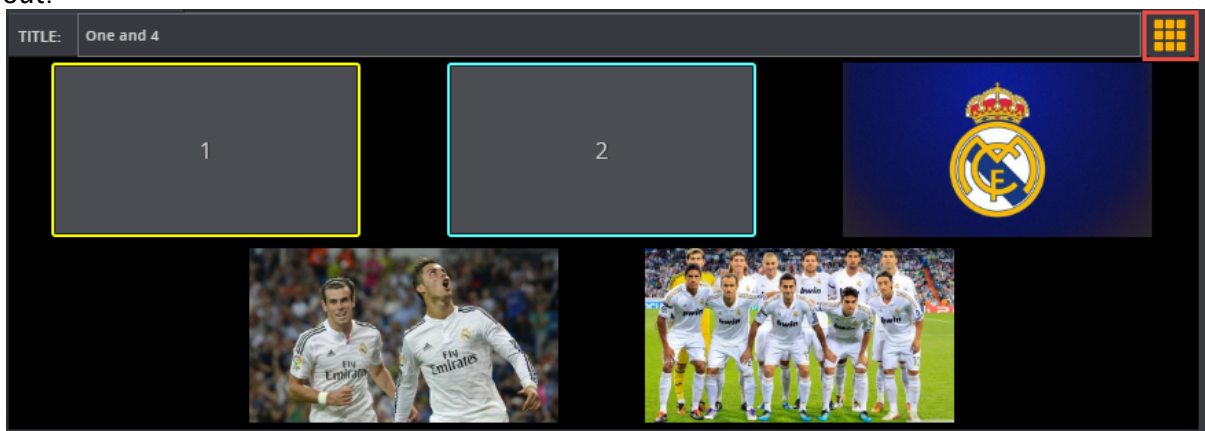

7. Once the video wall preset is filled (partly or completely) with elements, you can close the editor.
8. The preset thumbnails in the **Walls** group in the shortcuts playlist now reflect the content put into the video wall preset.

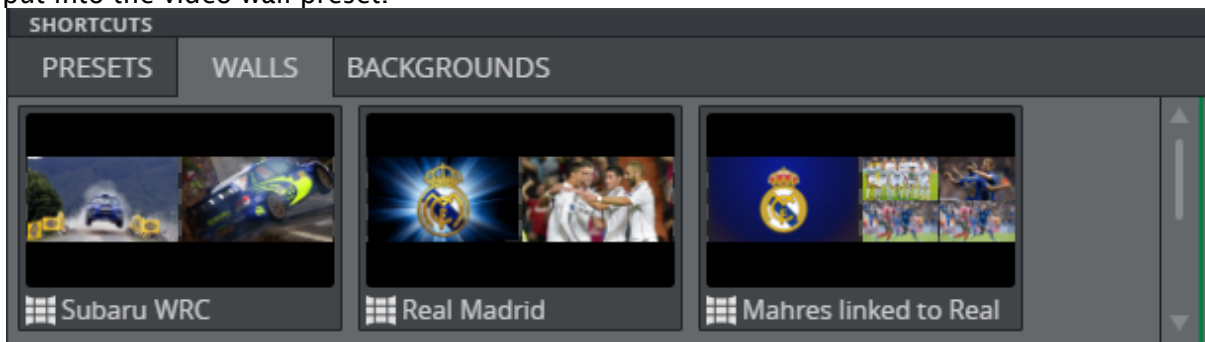

✔ **Tip:** It is possible to fill one or more GFX channels in a filled preset. The existing content of the non-filled GFX channels that are on air will then remain on air when a partly-filled preset is played out.

#### 4.6.4 Adapt the GUI for Pre-filled Walls

A nice workflow is to create a workspace where you hide all GFX channels and only show the main channel. Remove the shortcuts playlist and increase the thumbnail size to 200. You can then drag



presets from the Videowall tab over to the A channel and fill them with content. You then have a GUI where the operator can control full walls with a single tap:

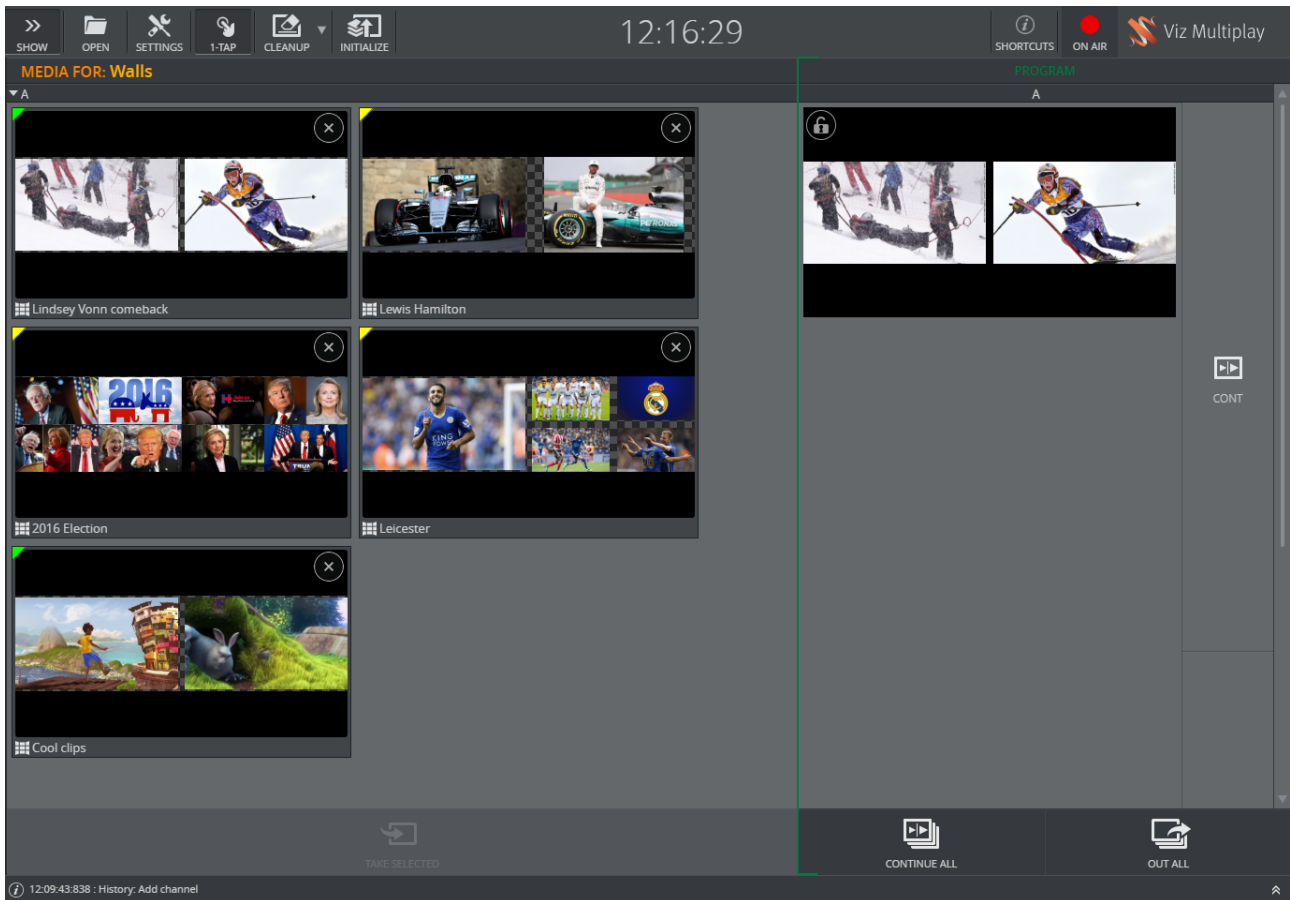

Only the main channel is visible in this workspace, and the thumbnails have a maximum size. With one click or tap, the Viz Multiplay operator can now toggle complete walls with layout and content.

#### 4.6.5 The Preset Content Editor

The Preset Content Editor is an editor for filling video wall [Presets](#) with predefined content, which are then referred to as [Filled Presets](#).



In the editor, search for content (videos, graphics, images) and drag it into a preset. Depending on your configuration, content is contained in various tabs, including the Templates, GFX and Media tabs etc. When the filled preset is ready, drag it either into the group for the main channel of the video wall, or to the shortcuts bar in the show.

1. Right-click a preset in the [Using the Shortcuts Bar](#) or in the main channel of the video wall.

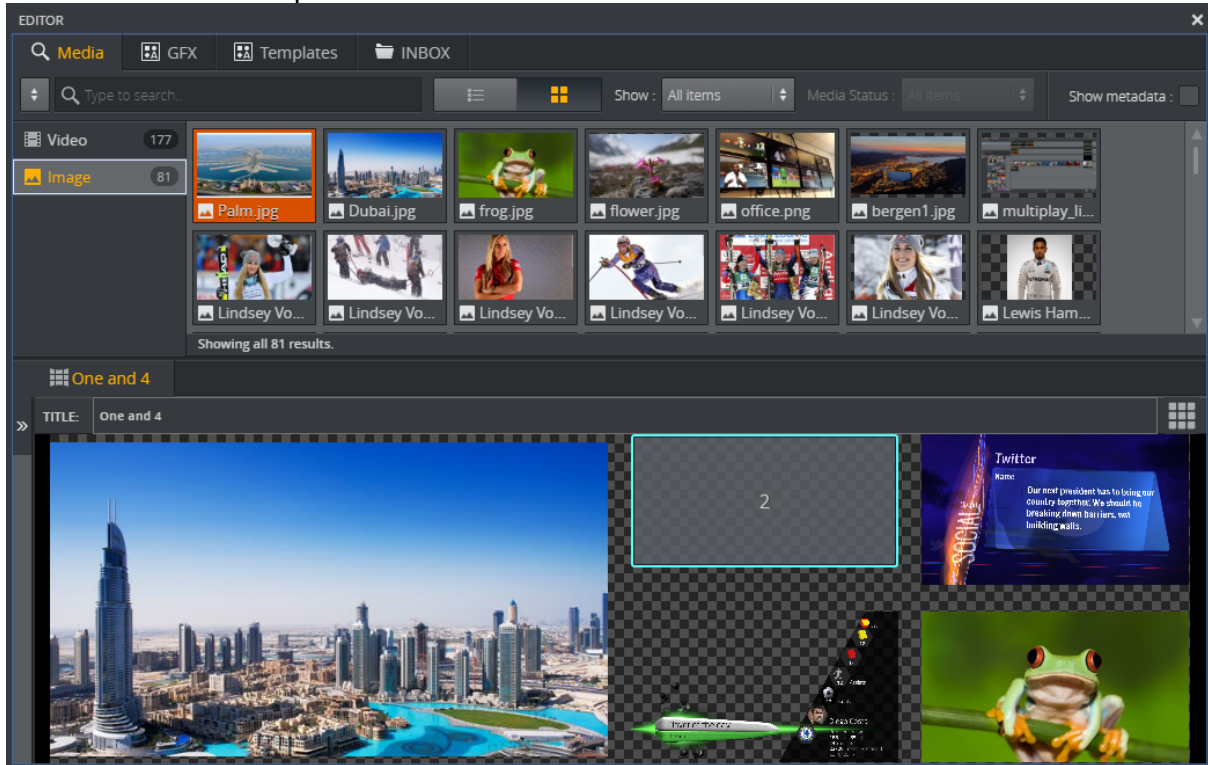
2. Click **Edit Content** to open the Preset Content Editor:



In this editor, you can create a video wall layout with content filled into the GFX areas:

- From the top tab bar, select a source for the content. This can be Media assets, graphics or content from an inbox.
- Drag selected content into the GFX areas.
- Click the Play button  on the thumbnails to edit, or alternatively double-click content or right-click and select **Edit**.
- Click the View Mode button  to switch between actual video wall layout and all GFX channels visible.
- Images that are dragged into an output channel, will automatically be cropped to fill the entire output area. The image is centered either vertically or horizontally, so it may be required to enter the image crop editor and adjust the auto cropping.

## 4.7 Working With Viz Pilot And MOS Rundowns

This section shows you how to set up a Pilot Data Server directly in Viz Multiplay and how you can use Viz Multiplay as a client to play out content from a newsroom rundown.

These are the following topics:

- [Working with Playlists](#)
- [The Newsroom Workflow](#)
- [Pilot Data Server](#)

## 4.7.1 Working with Playlists

Playlist definitions:

- **Internal playlists (show playlists)** are owned by the show, exported together with the show, and deleted when removed from the show. Viz Multiplay automatically creates three internal playlists when creating a new show: Shortcuts (for frequently used presets), GFX (for source graphics) and Videowall (for source presets that can be dragged into the show or into shortcuts).
- **External playlists** are created by an external system such as Viz Pilot or a MOS playlist from a newsroom system. External playlists are not owned by the show and are only referred to from the show. External playlists have the same appearance as internal playlists, but will not be deleted when removed from the show.

### Adding a Viz Pilot Playlist

These can be added as external playlists to your show:

1. Click the **Add (+)** button to the right of the tabs in the Show pane.
2. Click **Add external playlist**.
3. Find the playlist you want to add and click **OK**.

 **Tip:** Organize elements in shows and playlists in groups to ensure that they appear, as Viz Multiplay does not support playlist elements on the root level.

 **Note:** You cannot edit elements in Viz Pilot playlists if Media Sequencer is set up with an Oracle connection to the Viz Pilot database. You must then use Viz Pilot to edit the elements.

## 4.7.2 The Newsroom Workflow

In a newsroom workflow, the newsroom system (NRCS) is connected to a Viz Gateway. This configuration can be done in **Settings > MOS Config**.

When the newsroom rundown is activated, Media Sequencer synchronizes with the newsroom and contains one or more newsroom playlists. Media Sequencer is responsible for communicating with the Newsroom system through the MOS protocol and keeping MOS playlists up to date. Any changes are immediately reflected in Viz Multiplay.

### Adding a Newsroom Playlist to Your Show

1. Click the **Add (+)** button to the right of the tabs in the Show pane.
2. Select **Add external playlist**.
3. Browse to the MOS rundown you want to add and click **OK**. The playlist is requested from the gateway automatically.

## Requesting and Releasing a Rundown

To release and request a rundown again from Viz Gateway, right-click the MOS status label and select **Release** or **Request**.

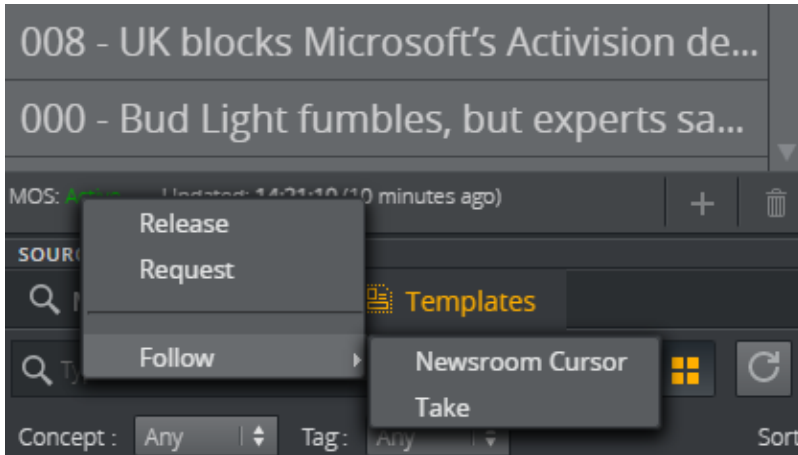

Media Sequencer now takes ownership of the MOS playlist and updates it live whenever the rundown changes. Because MOS playlists are organized in stories (groups), the elements will be visible in Viz Multiplay, and each story becomes one group in Viz Multiplay. Clicking the group exposes the elements in the group, organized per channel. The order of the elements in a MOS playlist is owned by the newsroom system, but single graphics elements can be edited in Multiplay. You can also drag elements from one channel to another channel.

Release the MOS playlist from Media Sequencer by right-clicking the MOS status bar and selecting **Release**.

**Warning:** Media Sequencer will stop updating the playlist for all clients connected to Media Sequencer once you have selected **Release**. Exercise caution when releasing a MOS playlist.

## The MOS Status Bar

The MOS Status Bar contains the status of the MOS playlist, showing active or inactive and the last-updated time and date:

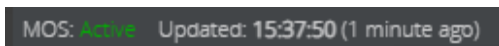

Additional information can be displayed when hovering the mouse over the updated-area:

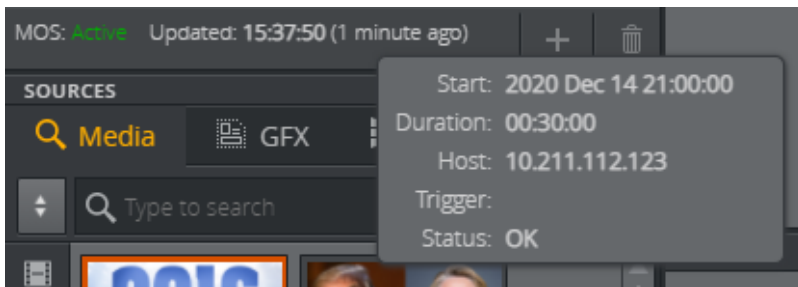

**Note:** Not all newsroom systems support all the fields in the information panel. An empty value can mean that the newsroom system does not support this information.

## Follow NCS Cursor

If the Newsroom system supports this feature, a check on the **Follow > Newsroom Cursor** on the MOS menu will make the current story in the newsroom system automatically select the corresponding group in Viz Multiplay. For instance, the ENPS newsroom system can be configured to send information about NCS cursor position by checking Timing Bar Position in the ENPS server configuration:

MOS Configuration				
Address *	Update MOS...	Block Item Cha...	Status Time Local	Timing Bar Position
<a href="#">Click here to add a new row</a>				
MSETEAM	<input type="checkbox"/>	<input type="checkbox"/>	<input type="checkbox"/>	<input checked="" type="checkbox"/>

When a cursor is moved from story to story in the newsroom system, the corresponding group in Viz Multiplay is selected. The operator can now play out elements in this group. If you select another group and want to get back to the newsroom cursor, uncheck the menu item and re-check it. This will select the group currently having the newsroom cursor.

**Info:** The Follow Newsroom Cursor functionality only works if the newsroom system supports `<roElementStat>` introduced in MOS protocol version 2.8.5.

## Follow Take

If a MOS playlist is controlled through an external system, it is possible to make the Viz Multiplay client automatically select the group of the latest taken element. For instance, an automation system can use the REST API of Media Sequencer to play out playlist items. The **Follow > Take** menu item will make Viz Multiplay listen to the last taken element cursor on Media Sequencer and jump to this.

## Assigning a Channel

In Avid iNEWS, you can specify the playout channel by right-clicking the item in the story and selecting **Assign Channel**.

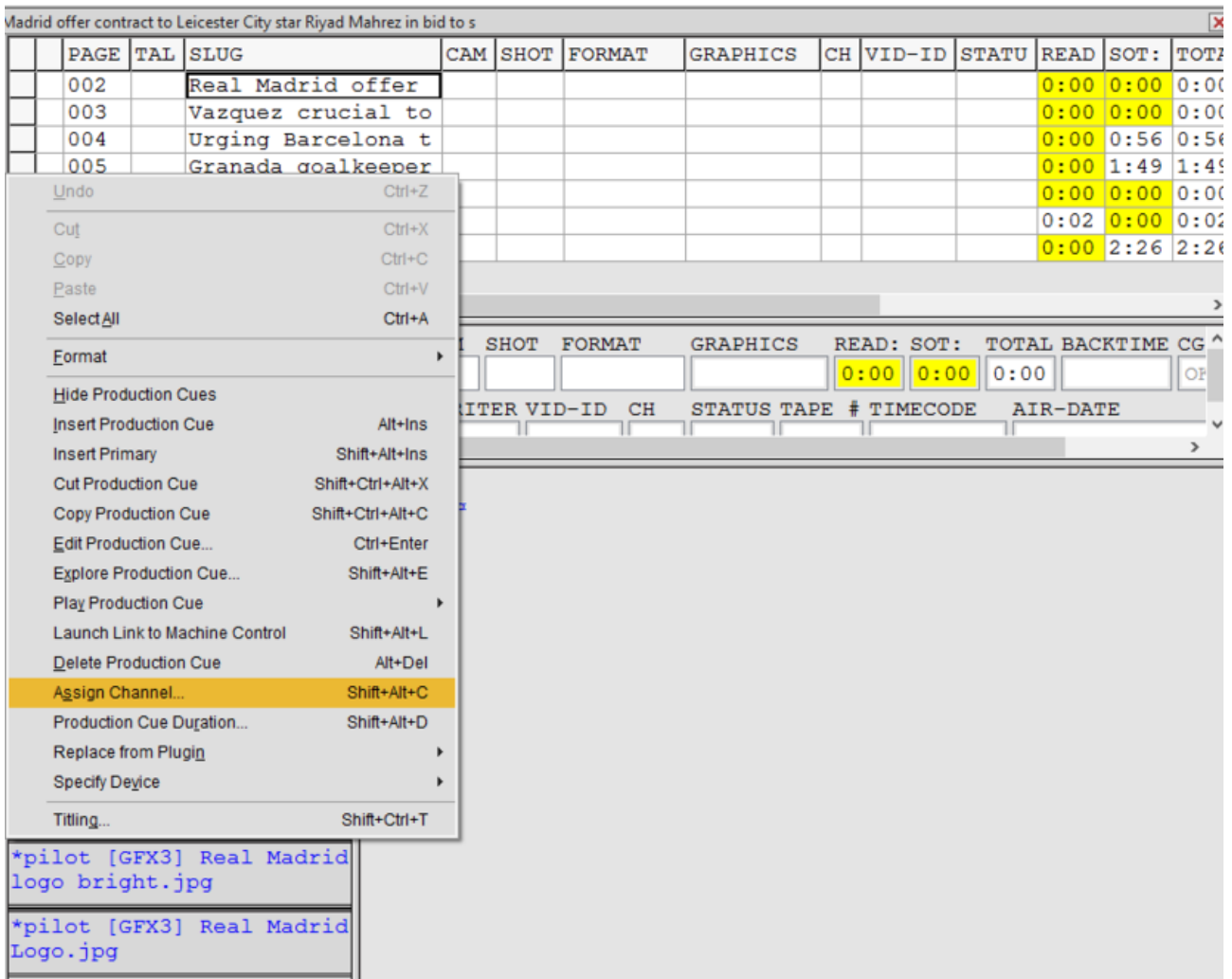

When Media Sequencer receives the MOS playlist, it sets the channel on the elements so Viz Multiplay can organize them under the correct channel in the GUI. This channel must exist in the active profile, elements without a channel will appear under the channel set as the Program channel.

### Writing a Channel to the Newsroom System

If you drag a MOS element in Viz Multiplay to another channel, it is possible to write the new channel back to the newsroom system. This feature must be enabled in MOS configuration:

**Warning:** Media Sequencer will stop updating the playlist for all clients connected to the Media Sequencer. Exercise caution when releasing a MOS playlist.

### 4.7.3 Pilot Data Server

If it is installed on your system, Viz Multiplay can connect to a Pilot Data Server and use the graphics directly without using an external Viz Pilot playlist.

To set up this workflow, both Viz Multiplay and Media Sequencer must be configured to use the same Pilot Data Server.

## Configuring Pilot Data Server in Viz Multiplay

1. Go to **Settings > Servers**.
2. Enter the URL or hostname to the Pilot Data Server in the Pilot Data Server input field.

✔ **Tip:** Enter only the host name and press **TAB**, Viz Multiplay auto completes the full URL.

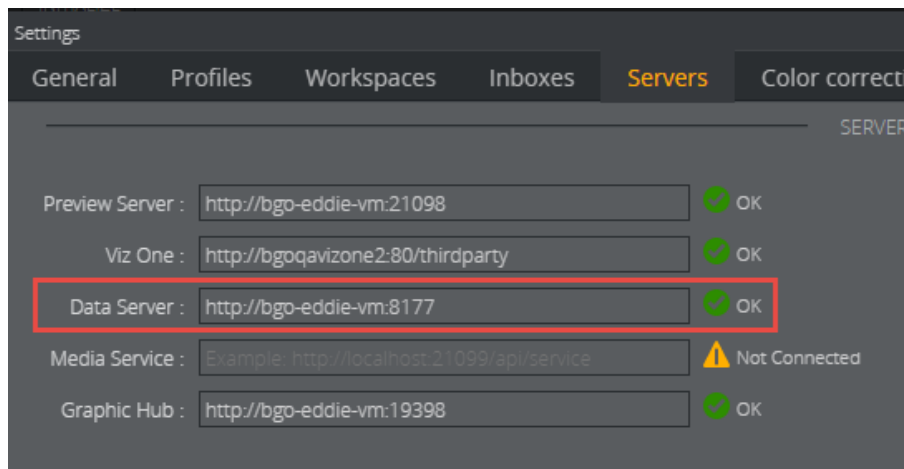

3. The **Templates** tab appears in the Sources pane once Viz Multiplay connects to the Pilot Data Server:

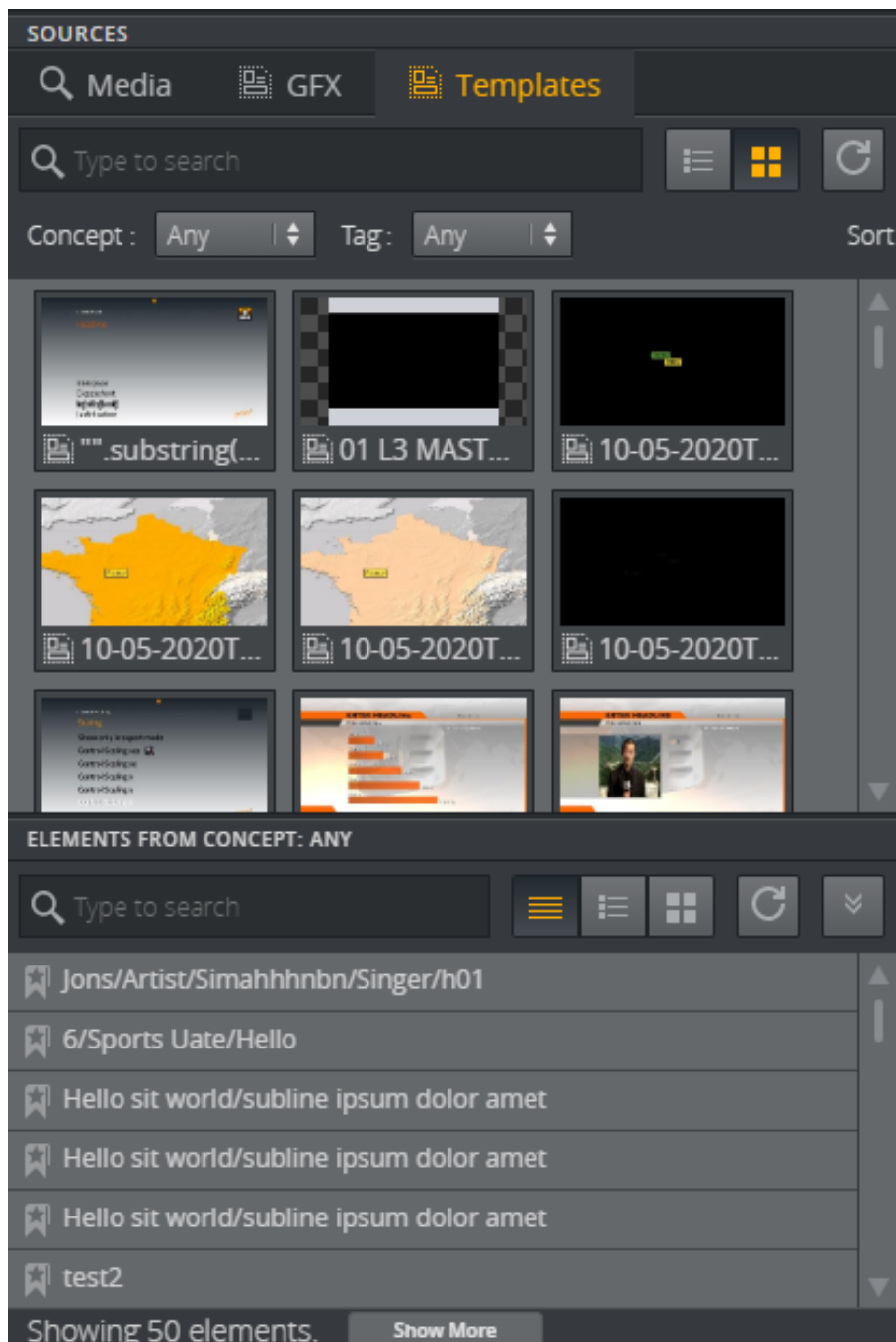

- ✓ **Tip:** The URL may be unreachable if the **Templates** tab does not appear after configuring the Pilot Data Server URL. Type the URL in a browser to see if you can connect to a Pilot Data Server.

The Templates tab contains Viz Pilot concepts and templates. Drag a template over to the playlist area, Viz Multiplay will now create a new Viz Pilot database element and insert a reference to it in Media Sequencer. Media Sequencer is responsible for connecting to the Viz Pilot database and inserting the element into Media Sequencer so it can be played out, and it also keeps the element up to date whenever a change is made to the database element.



## Connecting Media Sequencer to Pilot Data Server

Media sequencer needs to know which Pilot Data Server to connect to when a MOS playlist or a Pilot playlist is opened in Viz Multiplay. This is a one time configuration that can be done in **Settings > Pilot DB Config** panel.

For older Viz Multiplay clients, these are the manual steps:

1. In a browser, go to *http://mse\_host:8580/app/pilotdbconfig/pilotdbconfig.html*.
2. Add the host and port to the Pilot Data Server in the config GUI.

## Editing Pilot Elements in Viz Multiplay or Viz Pilot Edge

When you edit the Viz Pilot elements in Viz Multiplay (right click and select **Edit** or **Edit in Pilot Edge**), the changes are sent directly to the Viz Pilot database through HTTP. Media Sequencer detects any changes and updates the element in Media Sequencer automatically.

 **Note:** To set up editing Pilot elements in Viz Pilot Edge, the *mos\_plugin\_url* setting must point to the URL of Viz Pilot Edge. Viz Multiplay will pick up this setting and open Viz Pilot Edge from this URL.

---

## 4.8 Using A Switcher

This section covers using a switcher to control elements in the Media Sequencer. The switcher must support the PBus protocol.

A switcher provides an alternative to using the user interface to perform an action such as Take or Out on an element.

 **Note:** The various actions that can be performed on elements are described [here](#).

### 4.8.1 Background

The Peripheral Bus (PBus) protocol enables controlling the Media Sequencer from a switcher using a serial interface and a few simple commands. The hardware hookup is a serial line running from the switcher to the Media Sequencer machine. Since PBus is a one-way protocol, data flows only from the switcher to the Media Sequencer. The Media Sequencer supports three commands: Recall, Learn and Trigger.

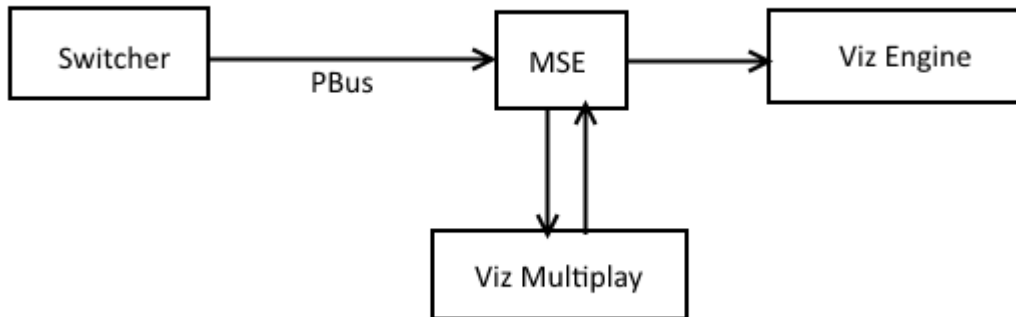

## 4.8.2 Workflow

- The switcher sends a **Learn** command with an ID to the Media Sequencer. This means that the Media Sequencer is now ready to connect this ID to an element.
- The Multiplay operator selects an element (a preset, a video, graphics, image etc.).
- The Media Sequencer has now connected the ID to an element.
- The switcher later sends a **Recall** command with an ID to the Media Sequencer. Now the Media Sequencer is ready to perform an action on this element.
- The switcher sends a **Trigger** command with a number representing an action. The Media Sequencer performs this action on the recalled element.

## 4.8.3 Configuring the Media Sequencer

From the **Settings > General** tab in Viz Multiplay, click the **PBus Switcher Config** button. A new browser window opens with the configuration application.

The screenshot shows a configuration window with the following settings:

- Config** (selected tab), Recalls, Actions
- Enabled
- Note: For changes to take effect, you might need to Disable and Re-Enable the PBus handler
- Port: COM4
- Device: 0
- Baudrate: 38400
- Stopbits: 1
- Databits: 5
- Parity: Odd
- Flowcontrol: None

Consult the manual for the switcher to find the settings that enable communication between the switcher and MSE. The Device number must match the device number of which the switcher sends commands to, because the switcher can be connected to multiple devices. Commands can thus be

sent from the switcher to one or multiple devices, by specifying the device number when sending the command.

There is no established connection between the switcher and the Media Sequencer, so it is not possible to test whether the connection is up or lost. The best way to test the connection is to send a Learn command from the switcher and monitor the result in Viz Multiplay. If a successful Learn command is sent from the switcher, a panel appears in Viz Multiplay. The following section explores this in more detail.

**Note:** You may need to disable and enable the PBus settings to make them take effect in the Media Sequencer. Click the Enabled checkbox twice.

#### 4.8.4 Learning Elements

A learn panel replaces the clock when the switcher successfully sends a Learn command to the Media Sequencer. This happens for all Viz Multiplay clients connected to the Media Sequencer.

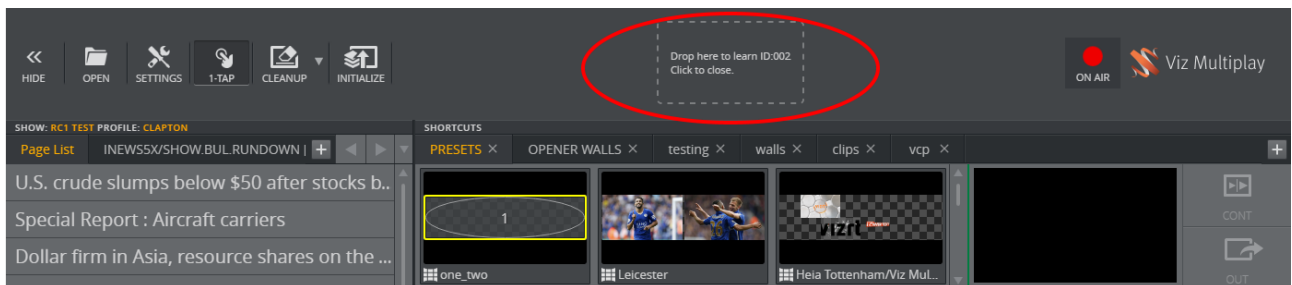

Drag any element from the Viz Multiplay GUI onto the learn panel. The panel then disappears. When this operation is done - the dropped element is connected to the ID given from the switcher. This completes the "learn" operation. The dropped element is now "learned" by the switcher, and can later be recalled with the given ID.

Verify and monitor learned elements by opening the PBus Config application.

1. Click the **PBus Switcher Config** button in the **Settings > General** tab in Viz Multiplay.

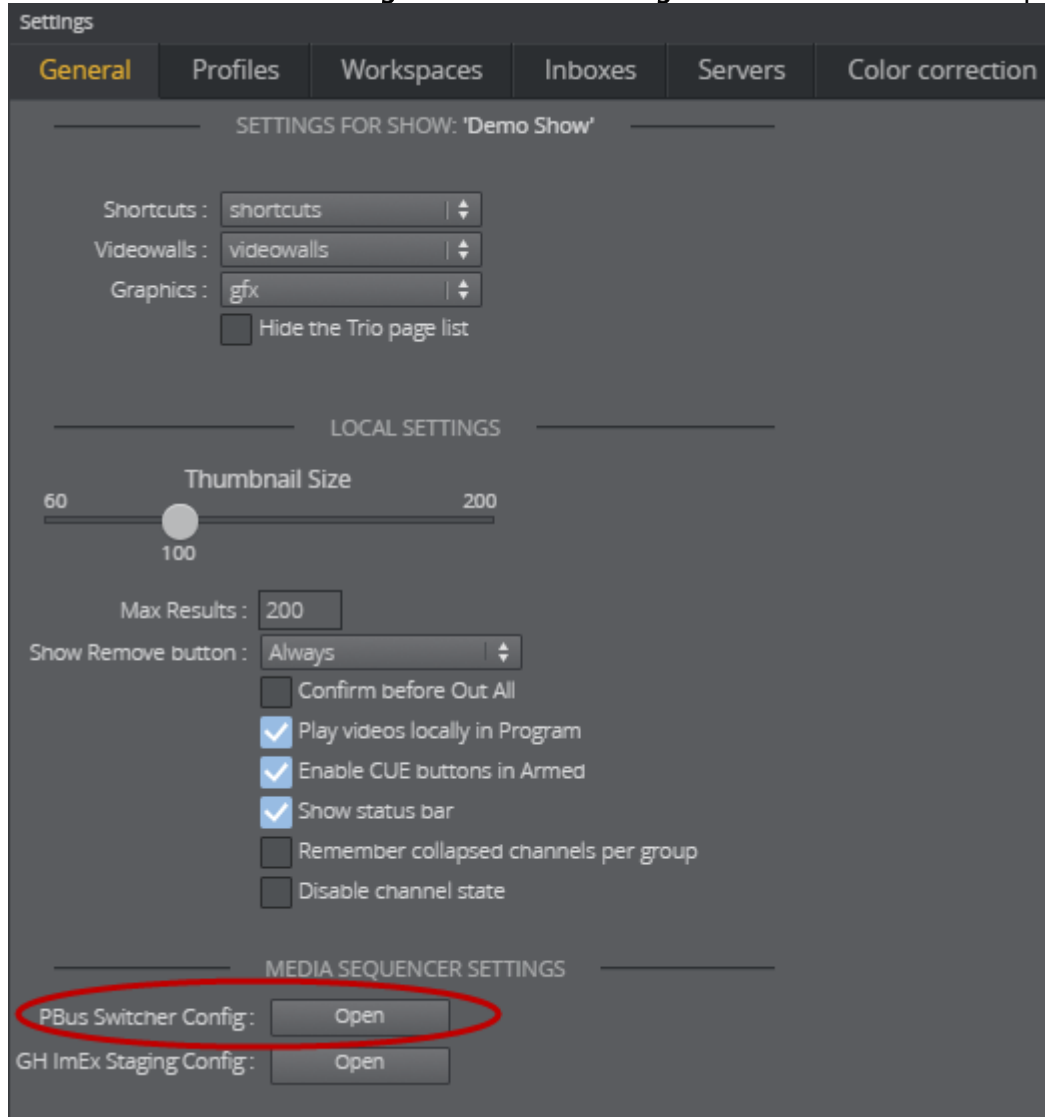

2. Click the **Recalls** tab, which contains a list of all the elements learned by the switcher.

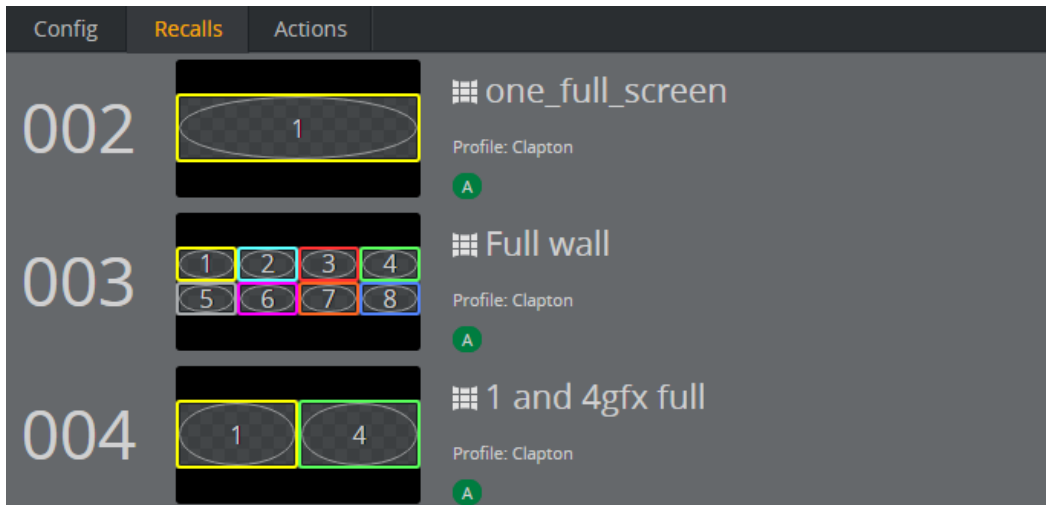

**Note:** Click the cross to the right in the window to remove a learned element from the list.

### 4.8.5 Recalling and Triggering

When the switcher wants to control a learned element, it sends a Recall command with an ID. The PBus Config then marks the recalled element.

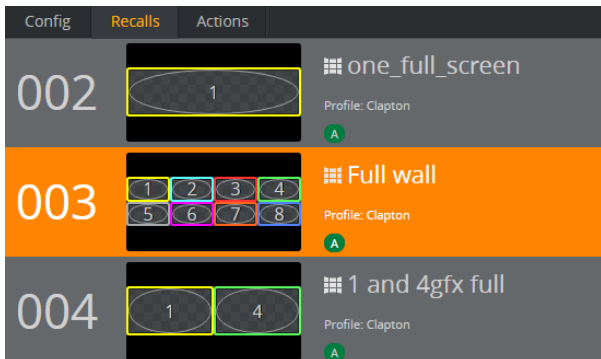

Now the recalled element is ready to receive actions. The switcher then sends a Trigger command with a number representing the action it wants to perform. The actions and their associated numbers defined default by the MSE are listed in the **Actions** tab.

Config	Recalls	Actions
ID	Action	
1	Take	
2	Continue	
3	Out	
4	Cue	
5	Pause	

✓ **Tip:** Configure switcher actions differently by editing the number associated with an action. For instance, the switcher sends a Trigger command with ID 0 to take an element on air, click the ID to the left of Take and change it to 0.

## 4.9 Using Graphic Hub Image Staging

This section covers how to use the Viz GH ImEx Agent, a Graphic Hub staging mechanism that automatically transfers images from URL resources to Graphic Hub.

The agent downloads and prepares the URL resources with the suitable compression level before transferring them to Graphic Hub. This means they use minimal resources on the renderer when taken to air, playing out without any framedrop.

These are the following topics:

- [Required Components](#)
- [Configuration and Setup](#)
  - [Install](#)
  - [Create Image Staging Folder](#)
  - [Set Publishing Point](#)
- [Workflow in Viz Multiplay](#)

### 4.9.1 Required Components

The workflow requires:

- Viz Graphic Hub
- Viz Graphic Hub REST service
- Media Sequencer version 5.0 or higher
- The [Viz GH ImEx Agent](#)

## 4.9.2 Configuration and Setup

Install and configure Graphic Hub ImEx over three steps by installing the ImEx Agent, creating an image staging folder and setting a publishing point.

**Info:** This procedure requires the following components to be installed: Media Sequencer 5.0 or higher, Graphic Hub and the Viz Graphic Hub REST service.

### Install

Install the [Viz GH ImEx Agent](#).

### Create Image Staging Folder

Create a folder in Graphic Hub where images should be staged to. See the Servers and Folders section in the *Graphic Hub Administrator Guide* on how to create a folder.

### Set Publishing Point

Use the Viz GH ImEx Agent to set up a publishing point to the folder through the GH REST service.

1. Enter the URL to the Viz GH ImEx Agent, then click **Options** and **GH REST Hosts**.

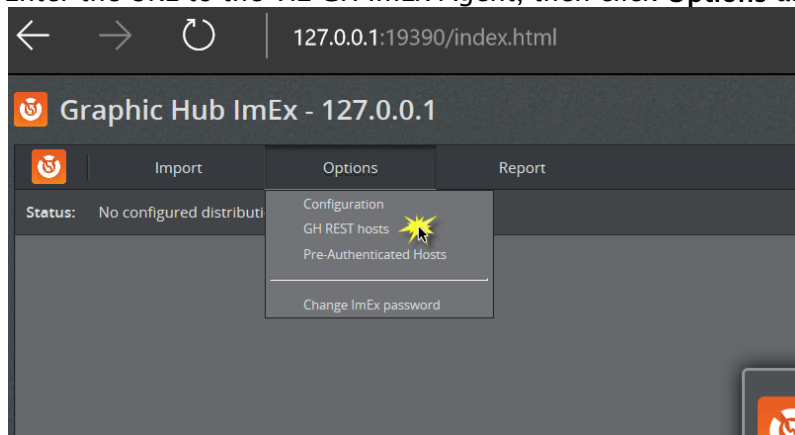

2. Click **Add GH REST Host**.
3. Select a server or enter the service document from a GH REST AGENT manually.

## 4.9.3 Workflow in Viz Multiplay

Enable media transfers via the ImEx Agent using the Viz Multiplay interface.

1. Click **Settings > General**, then click the **GH ImEx staging config** button.

- The configuration application opens in a new tab in the browser:

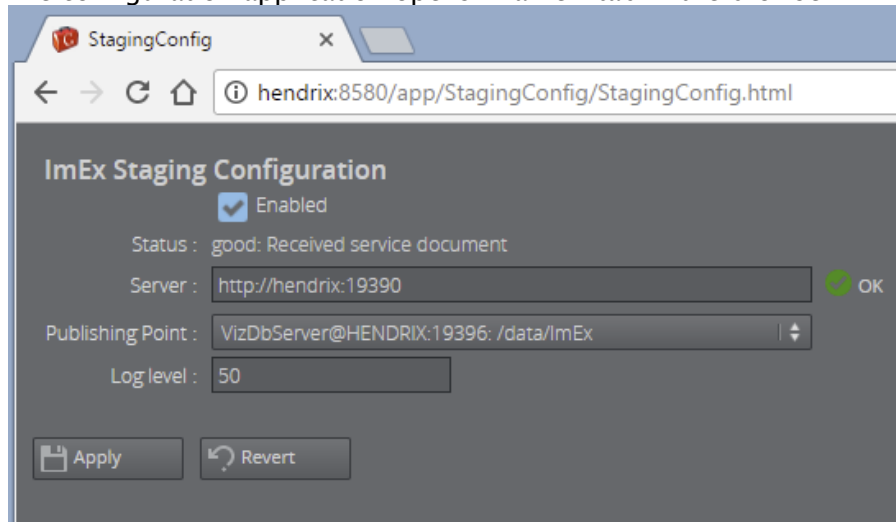

**Info:** The **Server** field contains the URL to the Viz GH ImEx Agent. This service is usually found on port 19390 on the host where it is installed.

**Note:** If Media Sequencer is configured with HTTPS, the ImEx Staging application will be opened through the HTTPS protocol. The ImEx Staging Configuration application does not support HTTPS, which means that the HTTP address of the config app must be manually used in the browser: <http://mse-host:8580/app/stagingconfig/stagingconfig.html>.

- If the connection is good, the **Publishing Point** dropdown is populated with possible Graphic Hub backends, where the images will be transferred.
- After activating a show profile, Media Sequencer monitors images in the show and transfers from the URL source to the publishing point.
- During the publishing operation, the progress is shown on the image, as shown here:

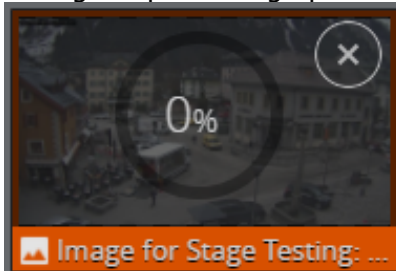

When the image is ready, the progress disappears:





**Info:** Set the **Log level** to a value between 0 and 100 to adjust the amount of log messages from the Image Staging handler on Media Sequencer. A higher level generates more log messages. This can be useful when inspecting the system during debugging. The log messages appear in the Media Sequencer log.

The **Revert** button undoes any local changes in the config window. It does not reset anything on Media Sequencer.

The **Apply** button applies the current settings to Media Sequencer.

## 4.10 Finding Media And Content In Sources Pane

See the Sources Pane to find media for your show:

- **Media Tab:** Search for assets in specified search providers.
- **Inbox Tab:** Content that is always available, across all shows.
- **GFX Tab:** Graphical elements to be used in your show.
- **Video Walls Tab:** Presets for Superchannel-based video walls.
- **Dynamic Walls Tab:** Presets for DynamicChannels based video walls.
- **Templates Tab:** Viz Pilot templates and elements.

**Note:** The **Show/Hide** button on the **Toolbar** allows you to **Hide Sources Pane and Show pane**.

### 4.10.1 Media Tab

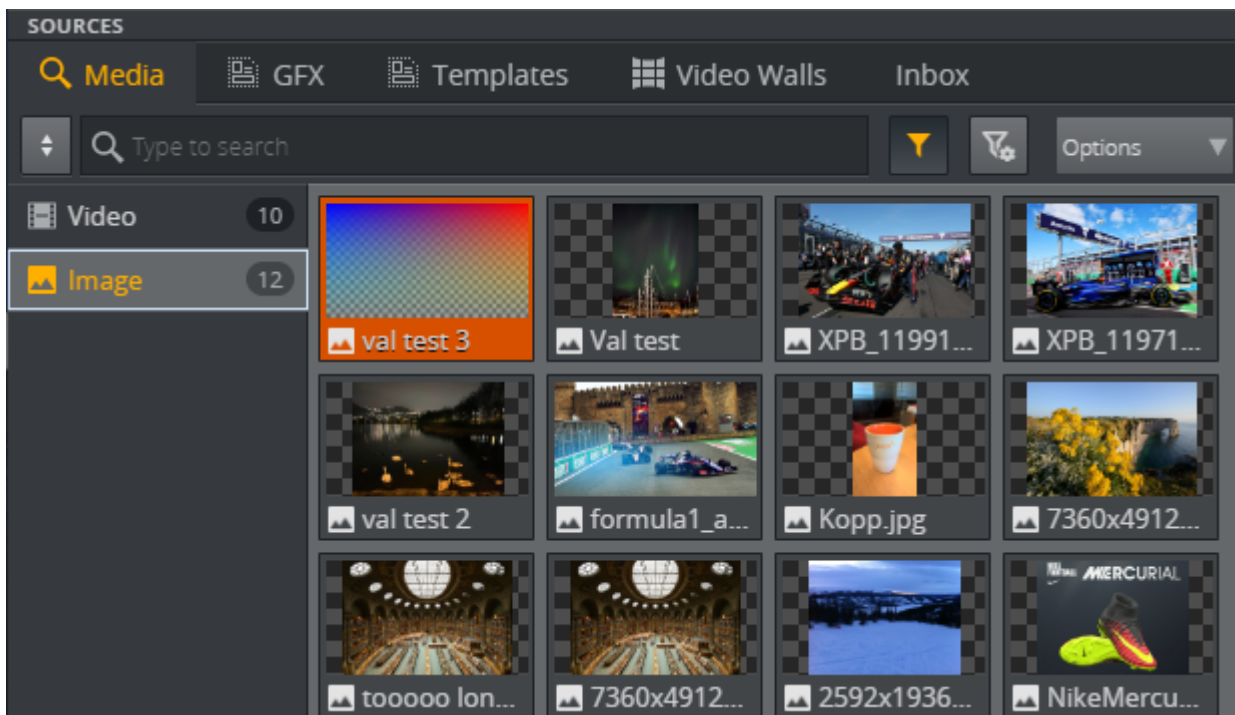

**Note:** Before using the Media Tab, make sure your search providers have been configured in **Settings > Servers Tab**.

In the Media tab, you can search for video and images in any of the search providers you have connected to, including Viz One, Media Service and Graphic Hub.

Once the element is found, drag it from the **Media Tab** to your channels.

## Add Items to Channels from the Media Tab

Drag individual items or groups of items into channels from the Media tab.

1. Click the Media tab.
2. Select a media type.
3. Drag an item into a channel.
4. Hold **CTRL** and click multiple items to drag them as a group into a channel.

## Standard Media Search Filters

**Note:** Not all search criteria is supported to all search providers. Unsupported criteria is hidden if unavailable.

**Keyword search:** Search descriptions

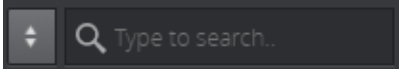

**Media type:** Video or Image

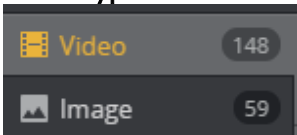

**Date range:** Filter by date. All items, Last hour, Last day, Last week, Last month. Works with media from Viz One, Media Service, Pilot Data Server.

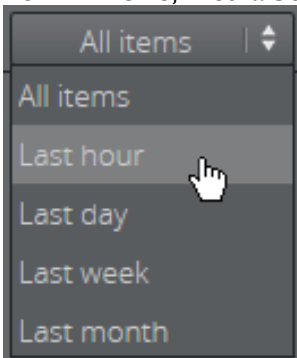

**Tags:** Works with media from Viz One. Only one tag can be selected at a time.

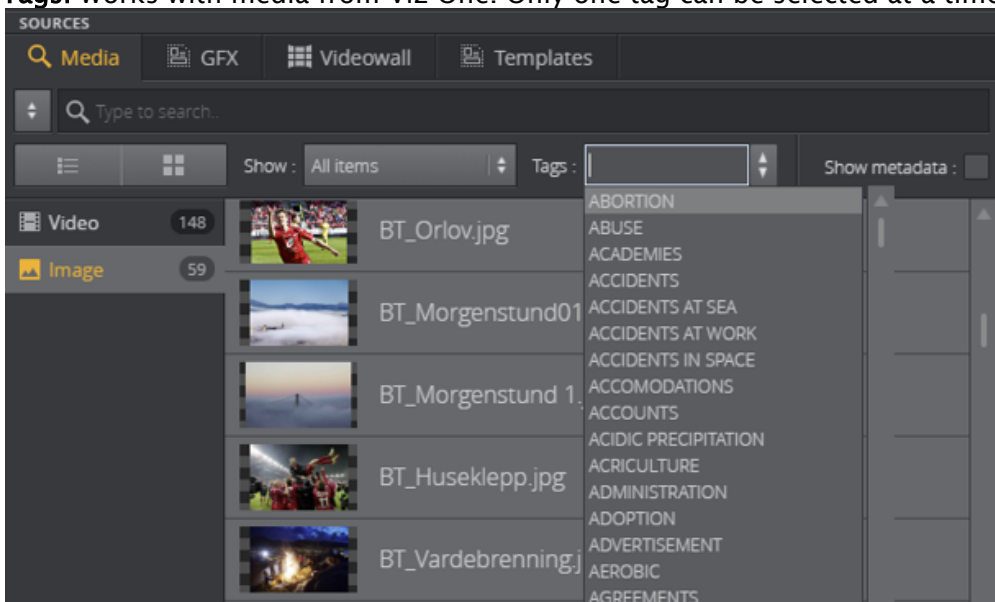

**Search Provider:** Select media sources for your search (Media Service, Viz One, Graphic Hub and Graphic Hub: default folder).

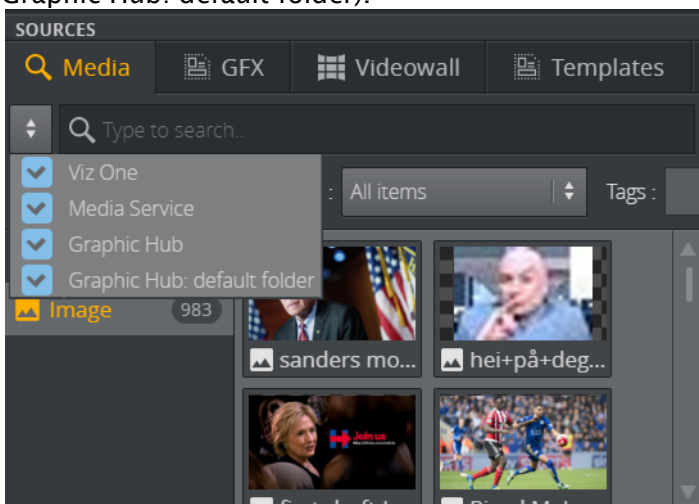

**Note:** Graphic Hub REST versions higher than 2.0.1 support **Graphic Hub: default folder** as a search provider, in addition to Graphic Hub. The default folder only contains images ingested through the Graphic Hub REST API, while the **Graphic Hub** search provider exposes the full content of the Graphic Hub.

**Note:** Viz One items marked as **Blocked** in the MAM system appear in search results with a visual mark. They are not usable in Viz Multiplay until they are unblocked in Viz one.

## Advanced Viz One Metadata Search

Viz One items can contain metadata specified on ingest. Viz One supports multiple metadata schemas in the same database. When searching for Viz One items, it is possible to search for items containing specific meta data. Any metadata field is searchable, and the advanced search filter can contain multiple metadata fields. If multiple fields are specified in the search, they act together with AND operator.

- Click the Media tab.
- Select Viz One as a search provider in the dropdown.
- Click the filter icon  to expose the metadata search filters.

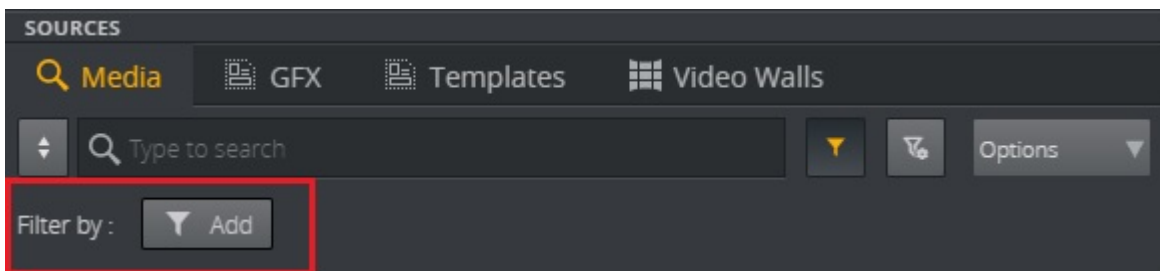

Now, clicking the **Add** button will expose an aggregated list of metadata fields in all the metadata schemas configured on the Viz One server. Start typing to look up a specific field. For each field, add a search criteria and click Add or Update to apply the new filter to the current search.

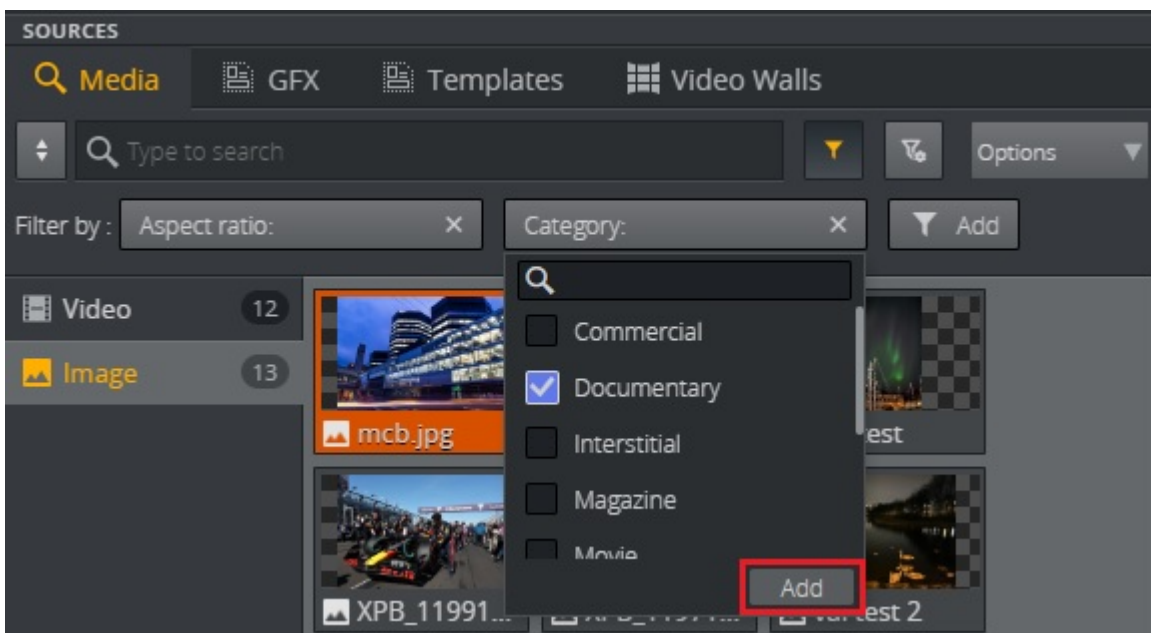

To load or save a specific set of metadata search fields, click the filter cogwheel button: 

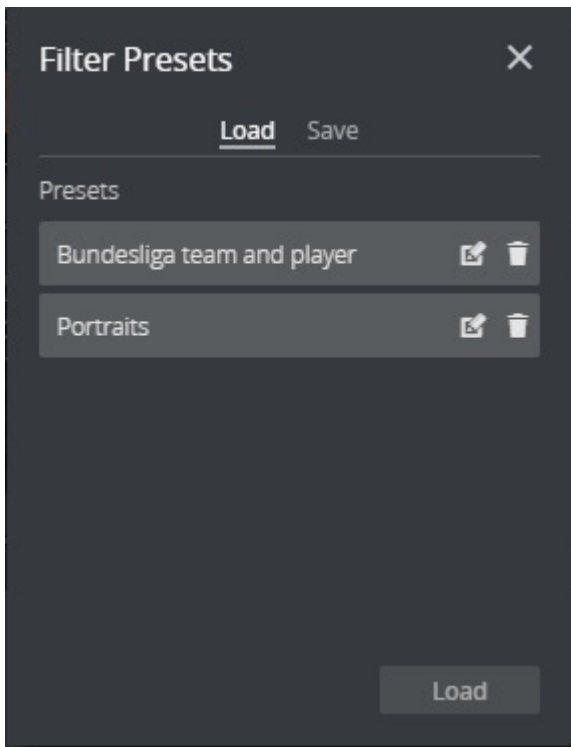

## Video Preview

To preview a video, right-click an item and select **Preview**.

Videos can be edited once they have been added to channels, see [Editing Videos](#).

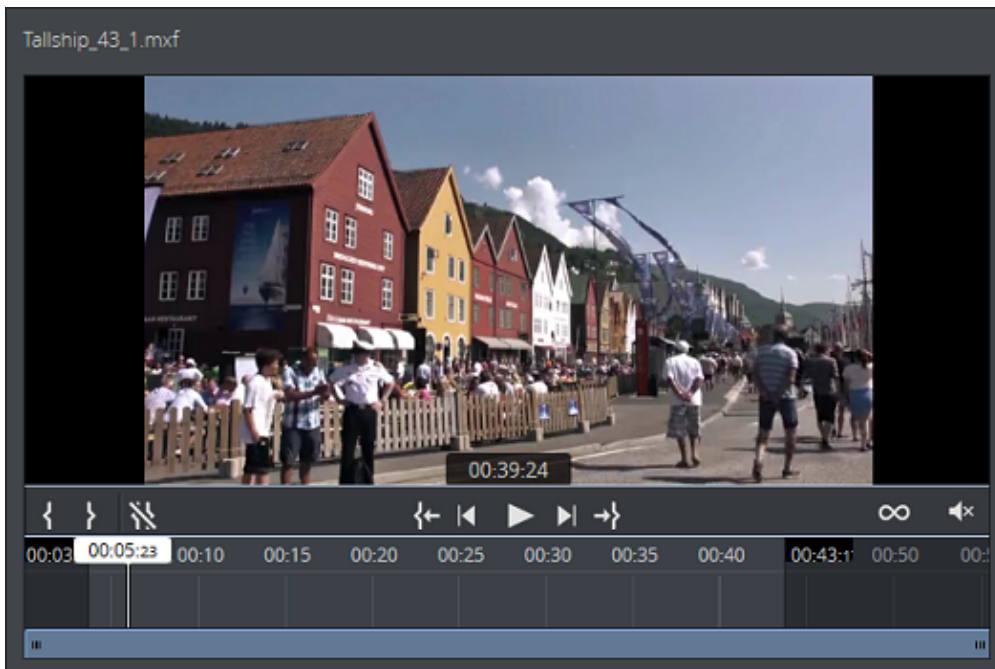

## 4.10.2 Inbox Tab

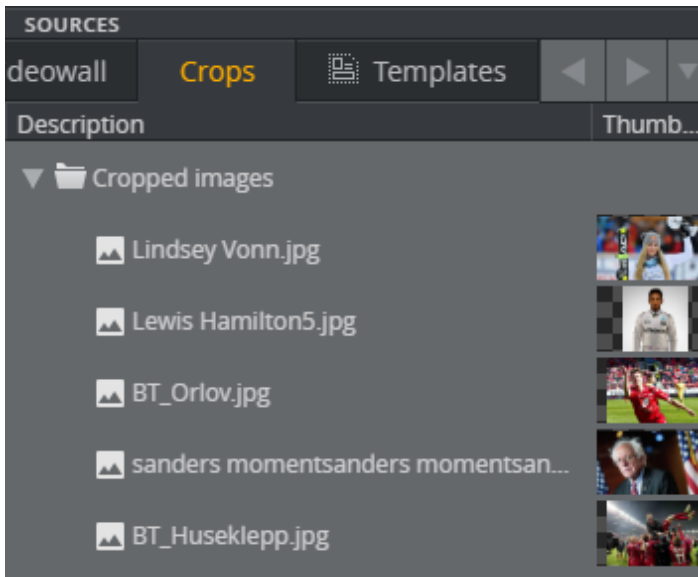

Users can work together to find and collect elements that can be easily added to a story. An inbox is global, meaning that it is available regardless of what show is currently open. Mark a show as an inbox by selecting it in **Settings > Inboxes Tab**.

Any content added to the show (for example, Crops) is immediately available in the Inbox tab. Elements can be dragged from the Inbox tab to a channel.

**Note:** When an element is dragged from the inbox to a channel in a show, it is copied, not referenced. This creates two separate elements that can be modified independently of each other.

**Note:** There are several ways to ingest elements into an inbox dynamically, for instance through the Media Sequencer REST API.

### 4.10.3 GFX Tab

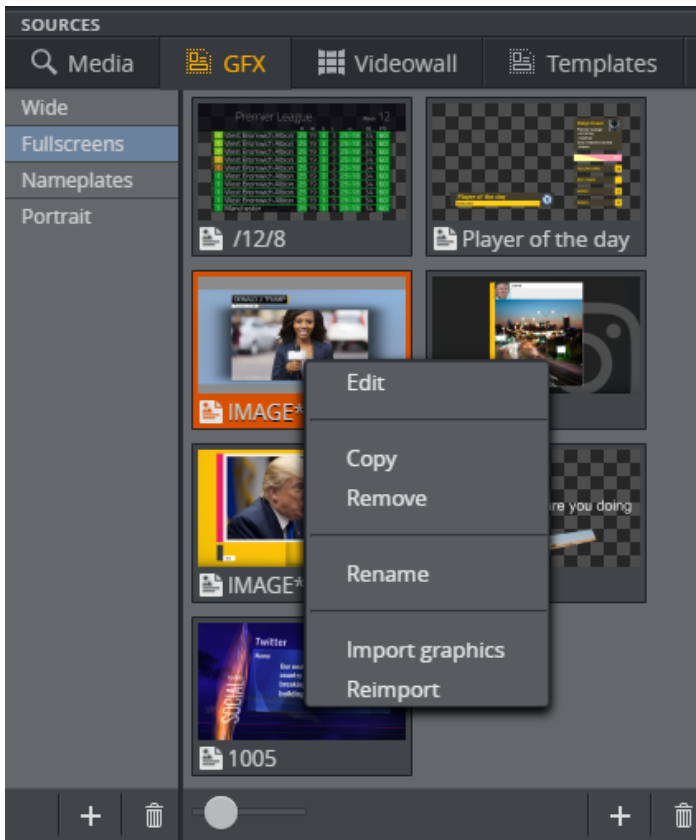

The GFX tab is a playlist within the show populated by importing Viz Artist scenes directly from the Graphic Hub or by using Viz Trio or the REST API of Media Sequencer. You can also drag or copy and paste elements from a channel into a group in the GFX tab.

**Note:** The content from the GFX playlist is only available within the show in which the playlist is created. A playlist is set as the GFX tab by selecting it in **Settings > General Tab > Graphics**.

The graphical elements can be empty templates or filled with content and can be edited once they have been added to a channel, see [Editing Graphics](#). Any changes made inside an element are immediately visible.

#### The Context Menu

Right-clicking an element in the GFX tab open the menu, which includes the following option:

- **Reimport:** Re-imports the graphics from Graphic Hub. This is useful if the graphics designer has added or removed control fields.

## Changing Thumbnail Size and Aspect Ratio

- Drag the slider right to view bigger thumbnails and left to view smaller thumbnails.



The thumbnails for each group in the GFX tab can have different aspect ratios. This is handy if you have wide scenes or portrait scenes meant for playout in GFX channels with the same aspect ratio.

- Right-click a group in the GFX tab.
- Select **Set Aspect Ratio**.
- Choose an aspect ratio or select **Custom**.
- In the custom box, enter a numeric value (width divided by height).

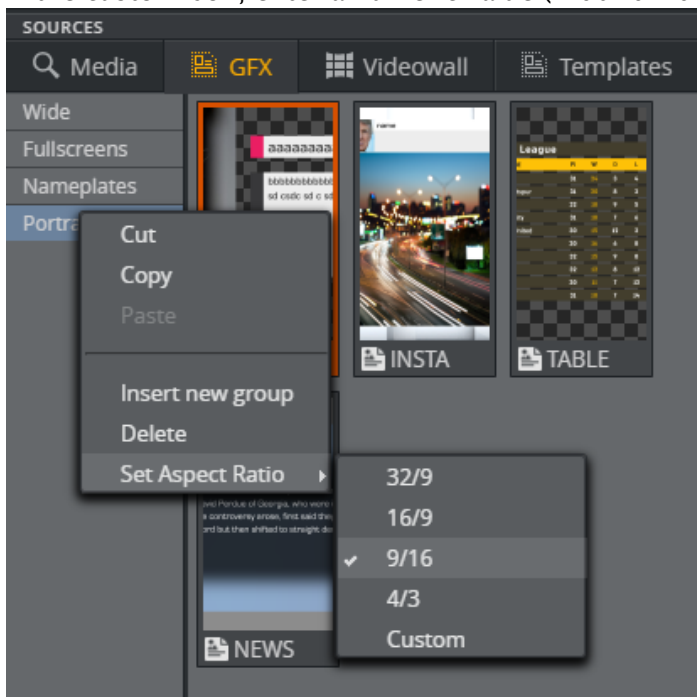

### 4.10.4 Video Walls Tab

The Video Walls Tab contains the Superchannel based video walls imported from the profile.



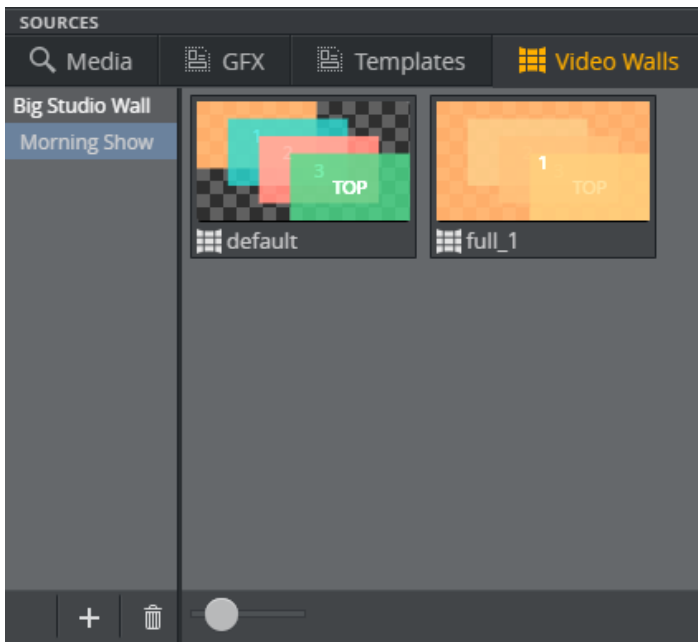

Click the **Plus** button to import new walls or new sets of presets (preset scenes) for a video wall into the current show. One video wall can have multiple sets of presets imported into the show. If a set of presets has a yellow triangle next to it, it indicates that the presets changed on Graphic Hub and they need to be reloaded. Right click and select **Reimport** to import the latest preset data from Graphic Hub. **Check for updates** will check whether the presets on Graphic Hub are updated since the last import, for instance if a designer has modified the preset scene in Viz Artist.

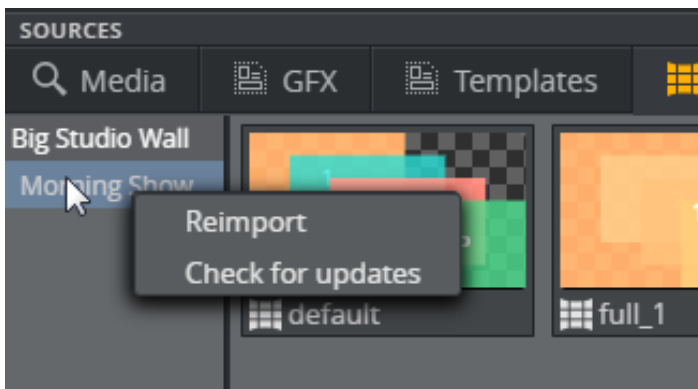

### 4.10.5 Dynamic Walls Tab

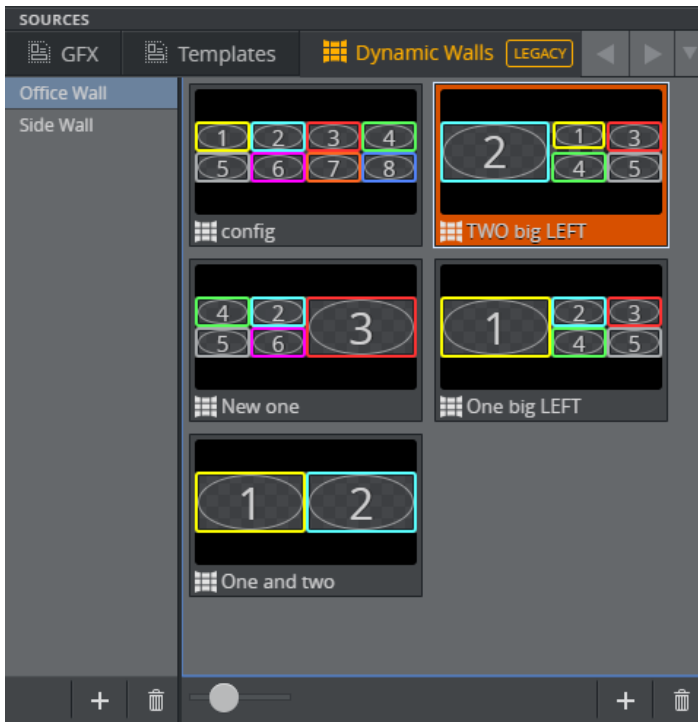

The Videowall tab contains the video walls created with the DynamicChannels solution in Viz Multiplay. The tab displays a regular playlist within the show that contains a set of [Presets](#) (video wall layouts). The content from this playlist is only available within the show in which the playlist is created. Set a playlist as the Videowall tab by selecting it in **Settings > General Tab > Videowall**.

The presets can be empty video wall layouts, or can be filled with content (media and scenes). The elements can be edited once they have been added to a channel (see [Editing Presets](#)). Any changes made inside an element are visible immediately.

#### Viewing Elements in the Videowall Tab

Drag the slider to adjust the size of presets:



#### Connect a Videowall Group to a Videowall

Playout all the presets in a group on a specific videowall.

**Tip:** Create one group for each videowall in a profile.

1. Right-click a group in the **Videowall** tab.

2. Select the desired videowall together with its main channel (the Viz output on which the videowall presets are run).

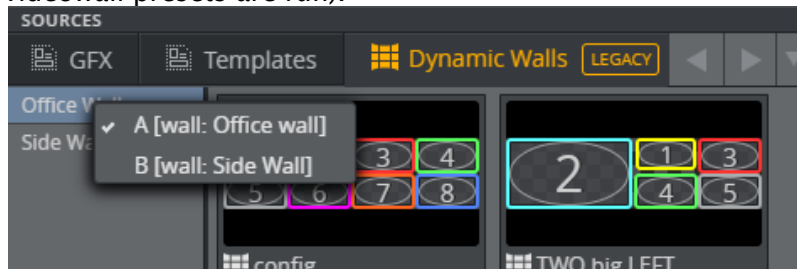

3. This group now only contains presets assigned to the selected videowall.

#### 4.10.6 Templates Tab

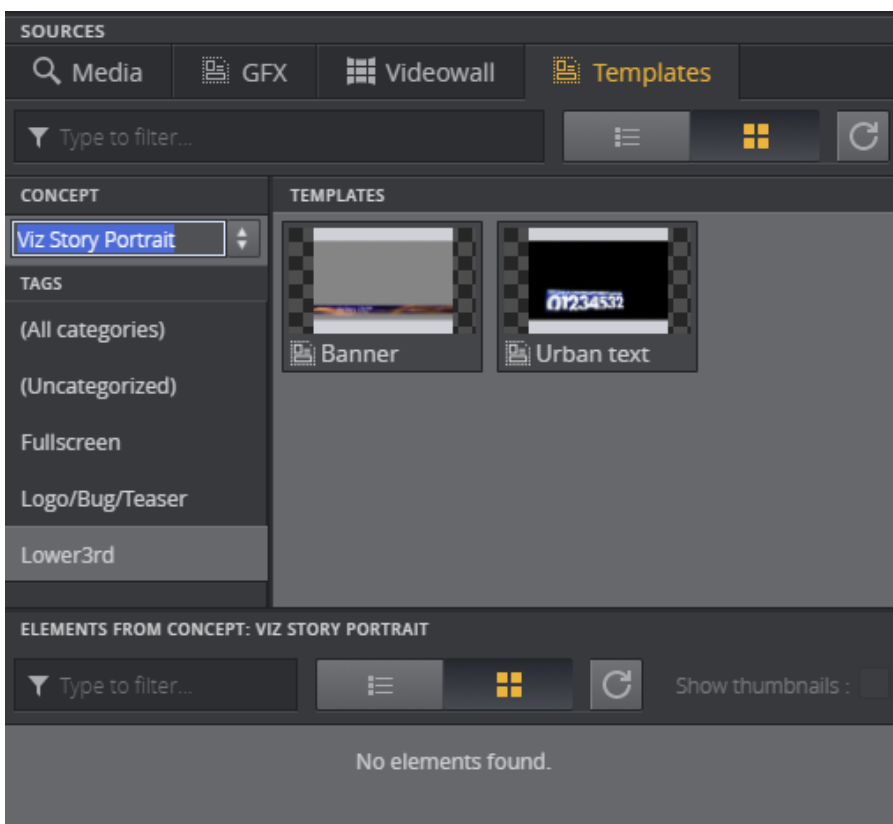

The Templates tab gives you access to Viz Pilot templates and elements.

**Note:** In order to access the Templates Tab, Viz Pilot must be configured as a search provider in **Settings > Servers Tab**.

Browse for a Viz Pilot template or an element. Right-click and select **Preview** to preview the graphics in a higher resolution.

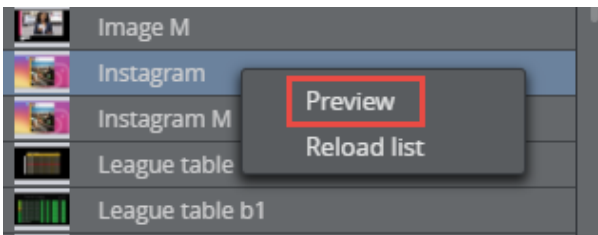

Drag templates directly into your channels. This will automatically create a new Viz Pilot element.

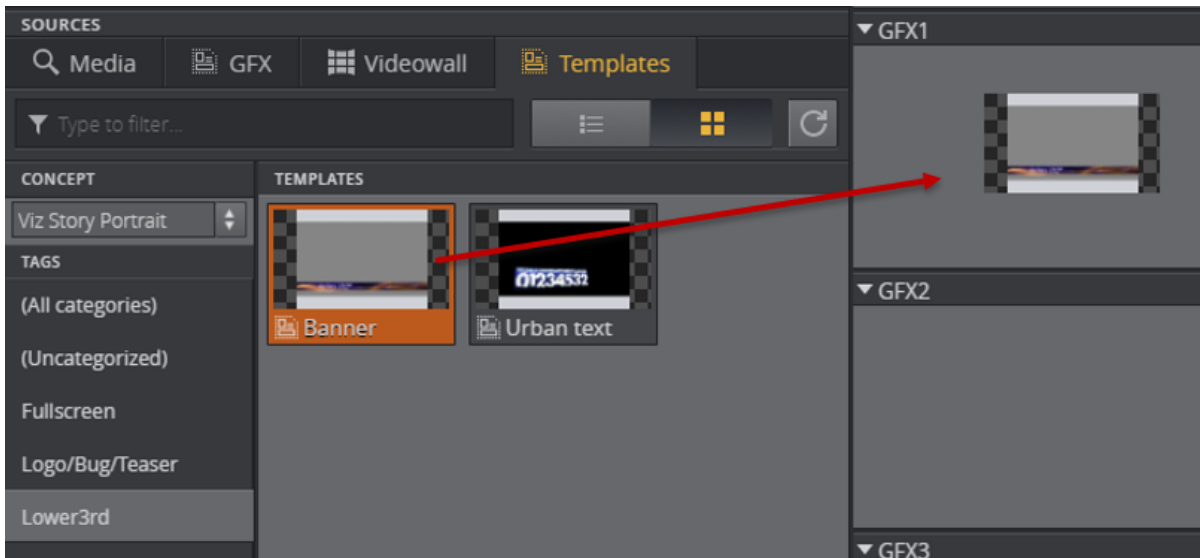

The templates can be edited once they have been added to a channel (see Editing Graphics). Any changes made inside an element are visible immediately.

## Working with Data Elements

Drag data elements from the Templates Tab into channels in the [Media Column](#).

This section covers:

- [Media Tab](#)
  - [Add Items to Channels from the Media Tab](#)
  - [Standard Media Search Filters](#)
  - [Advanced Viz One Metadata Search](#)
  - [Video Preview](#)
- [Inbox Tab](#)
- [GFX Tab](#)
  - [The Context Menu](#)
  - [Changing Thumbnail Size and Aspect Ratio](#)
- [Video Walls Tab](#)
- [Dynamic Walls Tab](#)
  - [Viewing Elements in the Videowall Tab](#)
  - [Connect a Videowall Group to a Videowall](#)
- [Templates Tab](#)

- [Working with Data Elements](#)
  - [What are Data Elements?](#)
  - [Where Can I Find Data Elements?](#)
  - [Refreshing the Data Elements List](#)
    - [Refresh the List](#)
  - [Filtering Data Elements](#)
    - [View Elements by Concept](#)
    - [View Elements by Template](#)
    - [List and Grid View](#)
- 
- [What are Data Elements?](#)
  - [Where Can I Find Data Elements?](#)
  - [Refreshing the Data Elements List](#)
  - [Filtering Data Elements](#)

## What are Data Elements?

Data elements are variations of a template.

For example, the same lower third may be used in both the morning and evening shows. Two different elements are created from a single template, each containing styling specific to the show for which it is created. The morning show element has a green lower third, while the evening show element has a red lower third.

## Where Can I Find Data Elements?

Elements are accessible at the bottom of the templates tab. Drag them into channels in the same way as templates.

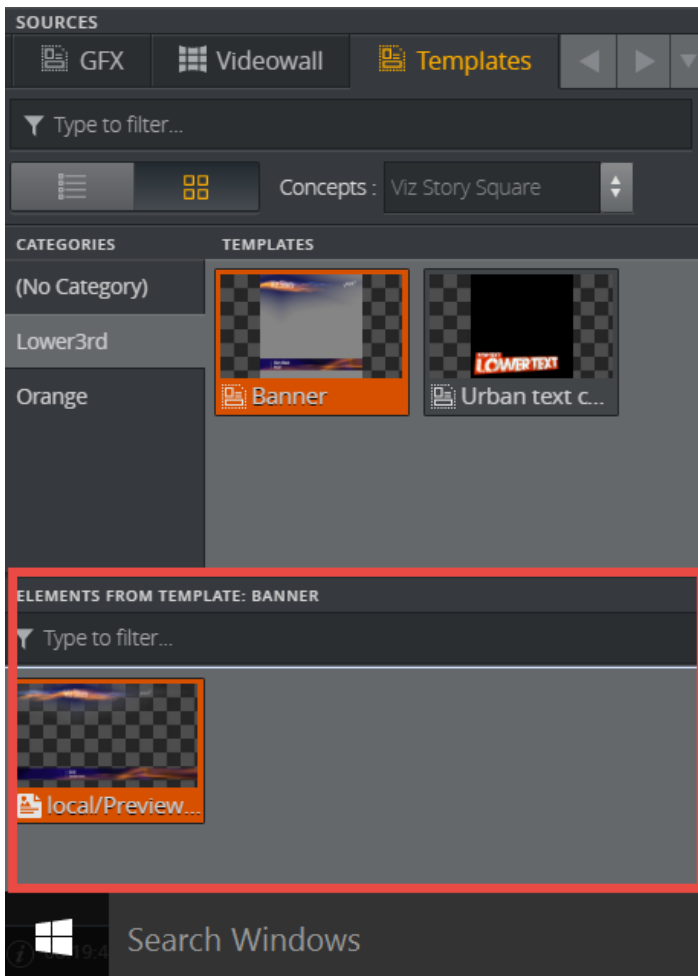

## Refreshing the Data Elements List

The data elements list is read out from the Pilot Data Server when a concept or a template is selected. This list does not change, even if someone is changing the list on the server. The list must therefore be refreshed manually.

### Refresh the List

1. Right-click an element in the data elements list.

2. Click **Reload list**.

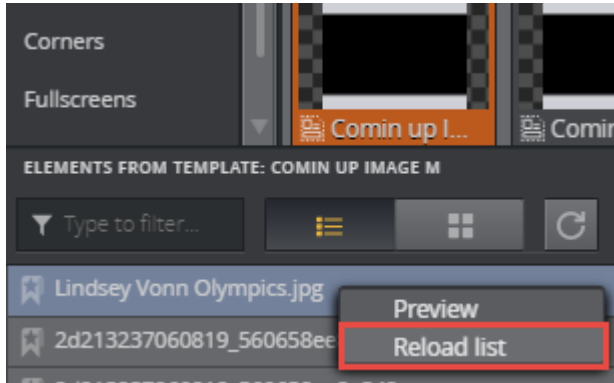

The current subset of data elements is reloaded from the server.

### Filtering Data Elements

Multiplay groups elements by concept and template.

**Note:** It is not possible to filter data elements by category.

### View Elements by Concept

Show all data elements belonging to all templates in a concept.

1. In the **Templates** Tab, click the **Concepts** menu and select a concept.

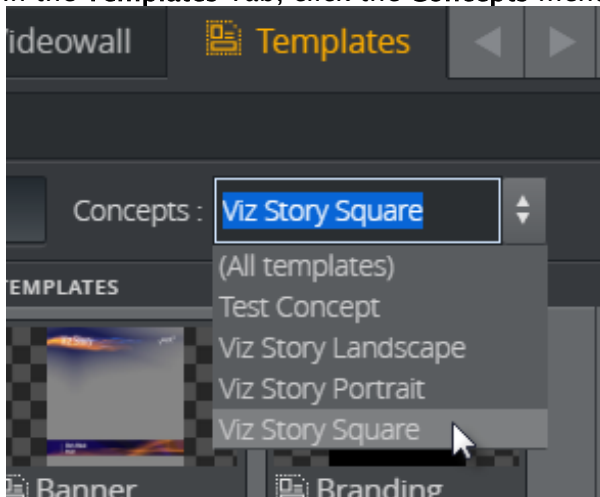

- Both templates (1) and elements (2) for the selected concept are listed.

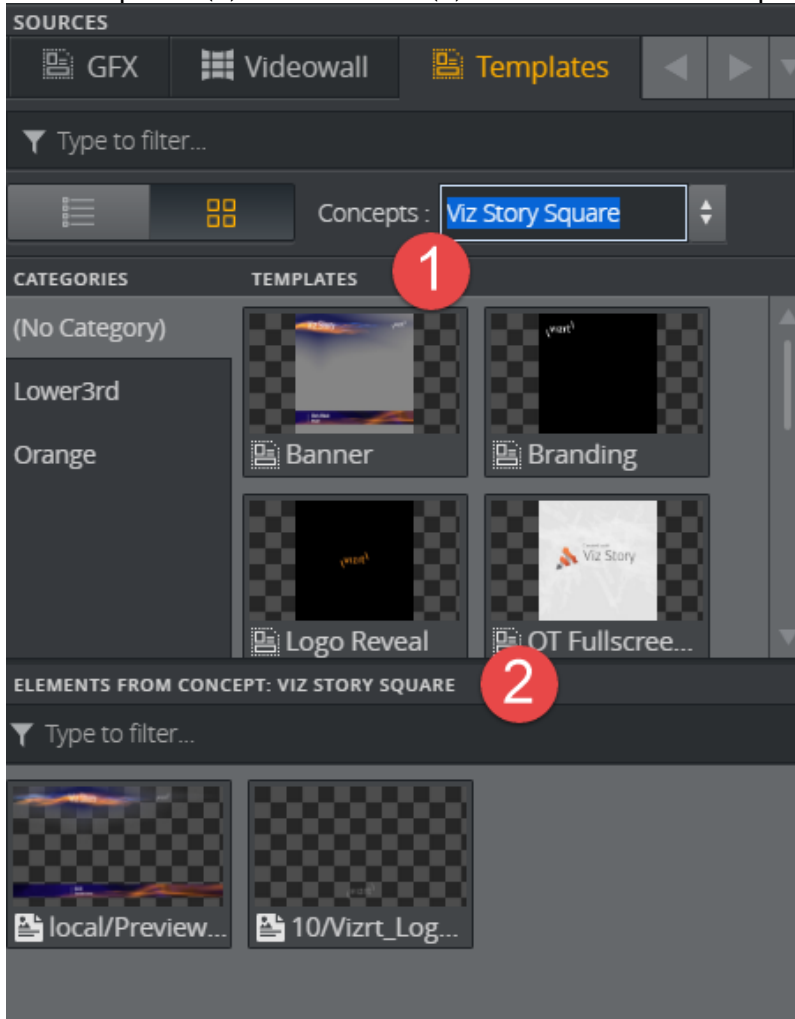

✓ **Tip: Elements from concept** is displayed to remind you that you are viewing elements associated with a concept.

## View Elements by Template

Show all data elements belonging to a specific template:



1. In the **Templates** Tab, click a template to view its elements.

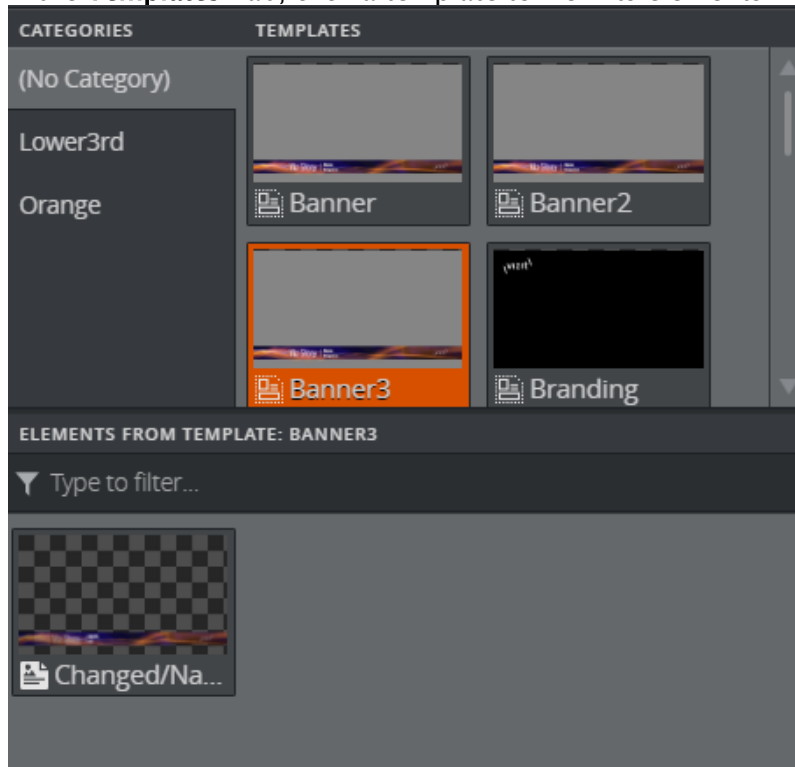

2. Here, **Banner3** contains a single element titled **Changed/Na...**

**Note:** Elements from template is displayed as a reminder that you are viewing elements associated with a single template.

## List and Grid View

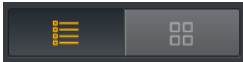
In the Templates Tab, click  to view elements and templates in list or grid view.

## 4.11 Editing Graphics, Videos And Images

Once items have been added to the [Media Column](#) in a story, they can be edited (right-click the item and select **Edit**).

The editing options depend on the type of media:

- [Editing Images](#)
- [Editing Videos](#)
- [Editing Graphics](#)

### 4.11.1 Editing Images

Use the Image Effect Editor to crop an image or add a zoom/pan animation.

#### Image Effect Editor

To open the editor, right-click an image and select **Edit**.

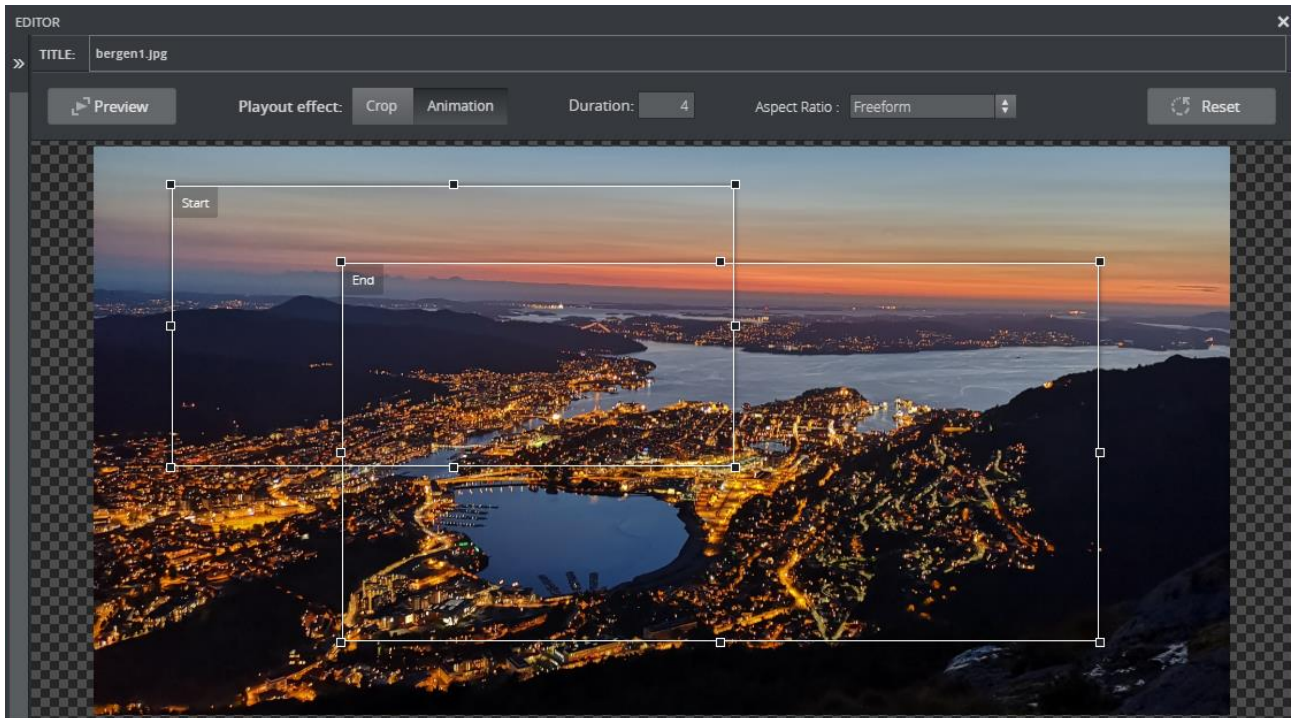

The Image Effect Editor allows you to crop or animate an image instantly using a crop rectangle. By default, the crop rectangle matches the image's aspect ratio, but you can also freely set the rectangle's aspect ratio.

To **animate** an image select a start and end frame and a duration for the animation. Preview the animation using the **Play/Stop** button. To **crop** an image, drag the rectangle to the desired size.

**Tip:** Hold **CTRL** before dragging the crop rectangle to maintain the current aspect ratio.

**Note:** All changes are live and cannot be canceled. The image editor uses a proxy image, therefore, the image may differ slightly when played out on a Viz Engine.

To force a different aspect ratio of the rectangles, select a value from the **Aspect Ratio** list. The values in brackets are:

- **Freeform:** Freely set the aspect of the rectangles.
- **Image:** Aspect is locked to the aspect of the image.
- **Output Channel:** For filled presets, the aspect is locked to the aspect of the Output channel the image is assigned to.

- **Profile Channel:** Locks the aspect to the aspect set on the channel in the profile configuration.

Click the **Reset** button to reset the effects applied to the default settings.

### 4.11.2 Editing Videos



#### Open the Video Editor

1. Right-click a video in a channel in the Media Column or in the Shortcuts Bar.
2. Click **Edit**.

✓ **Tip:** In Off Air mode, you can double-click media elements to edit.

#### Video Timeline Editing Options

The following buttons are available for video editing:

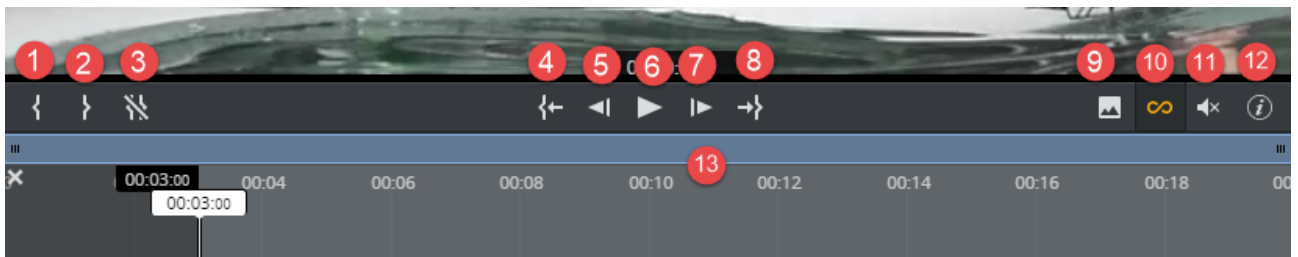

1. **Set Mark In:** Set an in point (I).
2. **Set Mark Out:** Set an out point (O).
3. **Clear Mark In/Out:** Clear in and out points (SHIFT + C).
4. **Go to In point:** Sets the playhead at the in point (SHIFT + I).
5. **Move 1 frame back:** Move the playhead one frame back (, -comma).
6. **Play/pause:** Play/pause the video (SPACE or CTRL + SPACE).
7. **Move 1 frame forward:** Move the playhead one frame forward (. -period).
8. **Go to Out point:** Sets the playhead at the out point (SHIFT + O).
9. **Set poster frame:** The current frame in the video editor will be used as thumbnail for the clip (P).
10. **Loop video:** Enable looping (R).
11. **Volume slider:** Adjust the clip volume (M to mute/unmute).
12. **List the keyboard shortcuts** (SHIFT + K).
13. **Zoom and pan:** Click and drag the edges of the blue bar to zoom and move it to pan the timeline.

**Info:** When setting a mark in point, the clip frame of this point will automatically be used as the thumbnail.

### 4.11.3 Editing Graphics

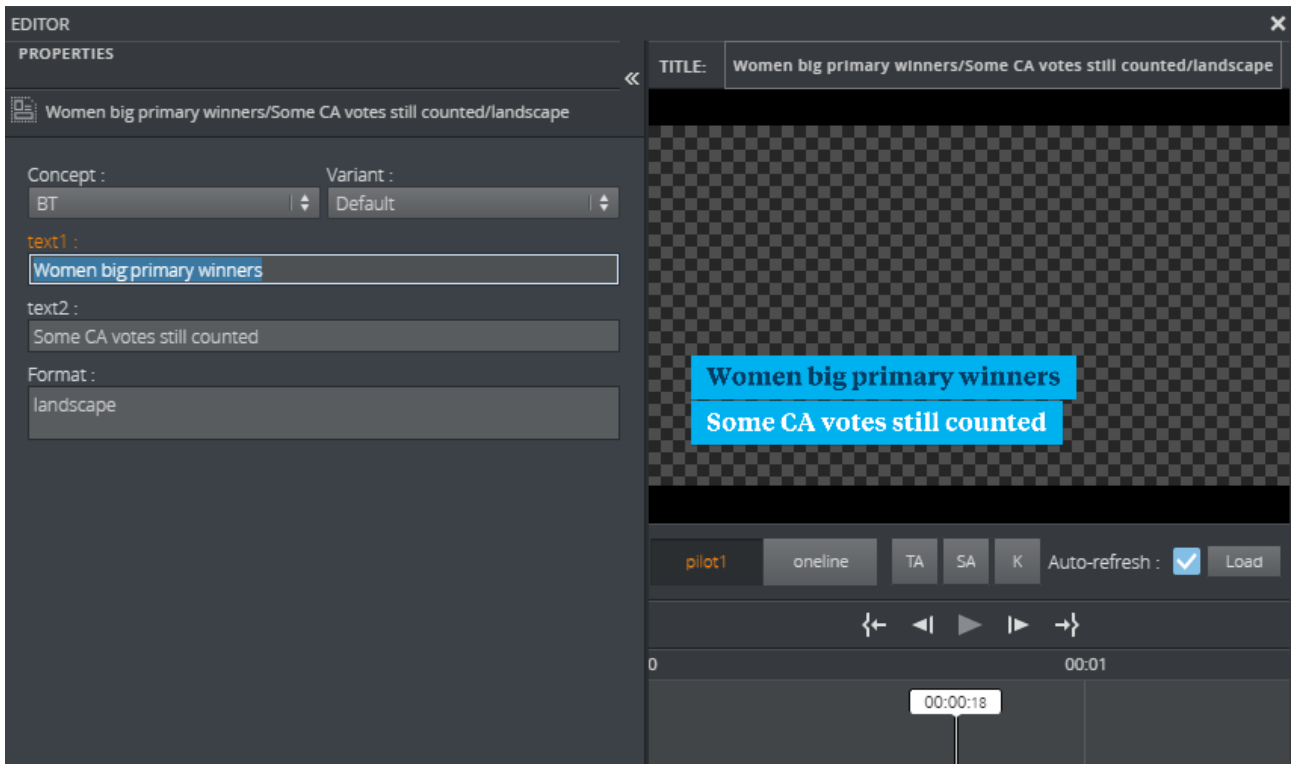

Open the Graphics Editor by right-clicking a graphics element and selecting **Edit**. Any changes made inside a graphical element are visible immediately.

On the left is the [Fill In Form](#), where you can edit the fields that are available in the graphical element, and on the right the [Preview Window](#).

**Note:** All changes are live and cannot be cancelled.

#### Fill In Form

The window to the left is a Fill In Form for the graphics. It displays fields that are exposed by the designer in Viz Artist where the user can add content to the graphic. This can include text, options in a drop-down list or media placeholders for media assets. Once changes are made in the Fill In Form, the Preview Window immediately updates to display them (if **Auto-refresh** is toggled on).

#### Custom HTML

The Fill In Form in Viz Multiplay is auto-generated based on the fields in the Viz scene. To change the appearance of the form, it is possible to replace some or all of the form with your own custom HTML. This is supported in Templates from a Viz Pilot Edge system. Although this is an advanced feature, the end result is that the user (the journalist or whoever fills in information) can view a completely customized interface. To use this feature, see the [Template Builder User Guide](#).

## Maps

Maps from Viz World can be used in the Fill In Form if the graphics contain a **Map** field. A Map field is generated when the Viz scene contains a map plugin, this can be set in [Template Builder](#) version 1.0.2 and later.

Once there is communication with a Viz World server the user can select from a list of available maps in Viz World. In order to edit these maps, a local Viz World installation is required. Since Viz World only runs on Windows, the Map Editor is only available when Viz Multiplay is running on Windows machines.

### Viz World Configuration

Viz World must be configured in a Pilot Data Server to establish communication between Viz Multiplay and Viz World.

In the Pilot Data Server Web Interface go to the *shared\_curious\_server* parameter (see the Database Parameters in the [Viz Pilot guide](#)) through Settings and add a hostname in the value column.

In the value column, use either:

- hostname or IP

or,

- full URL. Here the port must be defined

**Info:** A Viz World server defined in the Viz Multiplay URL (maps=mapshostname) will override the server defined in Pilot Data Server.

### Choosing Maps

1. To select a map, click **Choose map** in the Fill In Form.

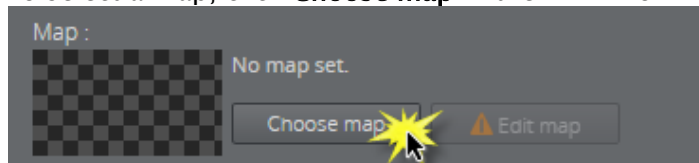

A dialog appears listing the maps that are available from the Favorite folder in the Viz World Map Editor.

## 2. Select a map:

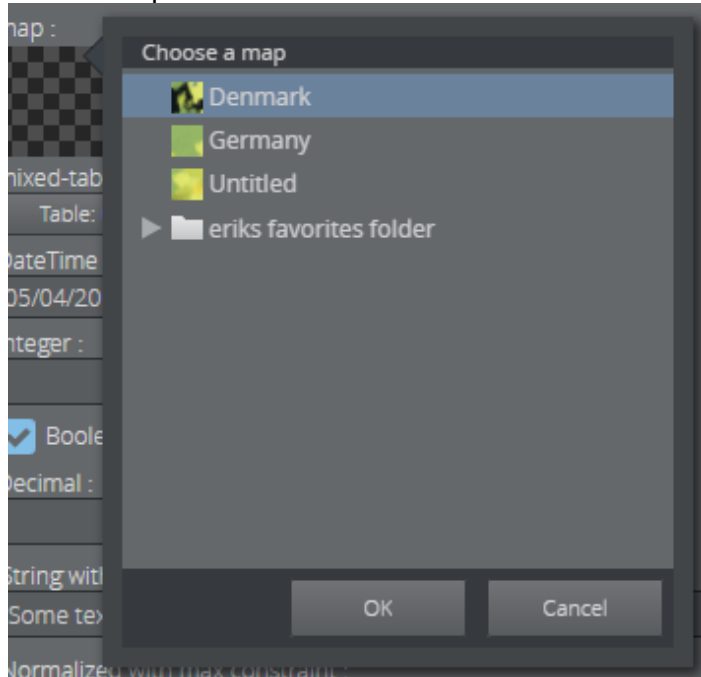

The map appears in the thumbnail in the Fill In Form and in the graphic in the preview window.

Choosing a map this way only requires communication with a Viz World server. However, a local Viz World installation is required to edit maps. See below.

### Edit Maps

The **Edit map** button is enabled only when a Viz World client 17.0 or higher is installed on the computer running Viz Multiplay, and the Map Client service is running. Normally the service is located in: `C:\Program Files\Vizrt\Common\Maps\MapClient.Service.exe`.

1. Double click this file. A window pops up and closes, and the service is now running.
2. Once a map is chosen and there is a running Map Client on the machine, the map can be edited. Click **Edit map**:

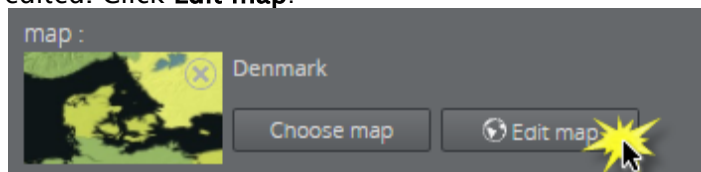

This opens up the Viz World Map Editor. All edits are performed inside this client, which means that Viz Multiplay has no control over your actions here.

3. After the map has been opened in the Map Editor the name is changed to *Denmark [modified]*, for example, indicating that the map has been edited. To cancel the edit mode, click **Cancel edit**:

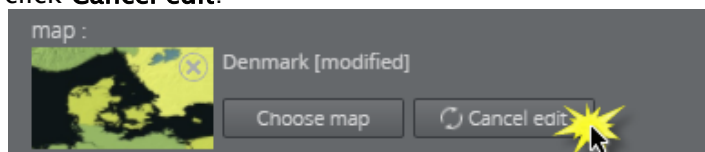

**Warning:** Clicking outside the Viz World Map Editor while it is open hides the window behind the Viz Multiplay window. Viz Multiplay will keep listening for data coming from Viz World until the window is closed. Recover the Map Editor from the taskbar and close it, or click **Cancel edit** from Viz Multiplay.

Although the map thumbnail view will not be available after saving and re-opening a template including a map, the map will still be there. Once the Viz World Map Editor is opened and communication is established, the map thumbnail view is available.

The Preview Window will update according to the selected map and edits performed on it.

## Warning Signs

Warning signs and grayed out map buttons indicate that the Viz World service is unavailable or that there is an error from the service.

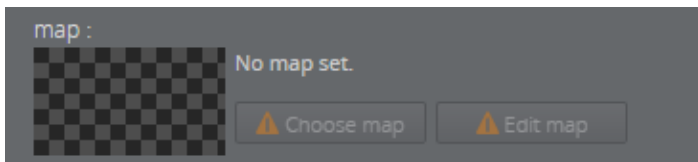

If no map is chosen or no default value is found, the **Edit map** button will be grayed out with a warning sign. A map must be chosen before edits can be made.

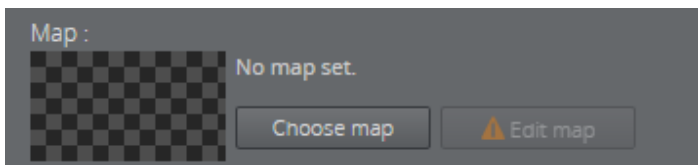

If a map is chosen, but the **Edit map** button is still grayed out, the map client is not detected.

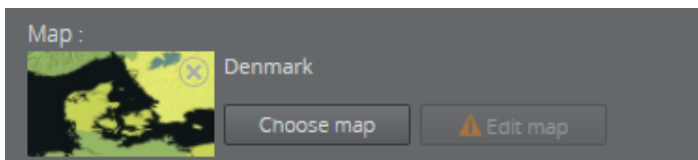

## Feed Browser

If a graphic template contains a **Browse** button in the Fill In Form, the user can browse for a feed entry. The feed entry URL is pre-set in the template. Use Template Editor to change a field type from pure text to a Browse button linked to an Atom feed, or a dropdown with fixed options.

Using the Feed Browser in the Fill In Form for a graphic is shown below:



1. Click the **Browse** button to open the Feed Browser.

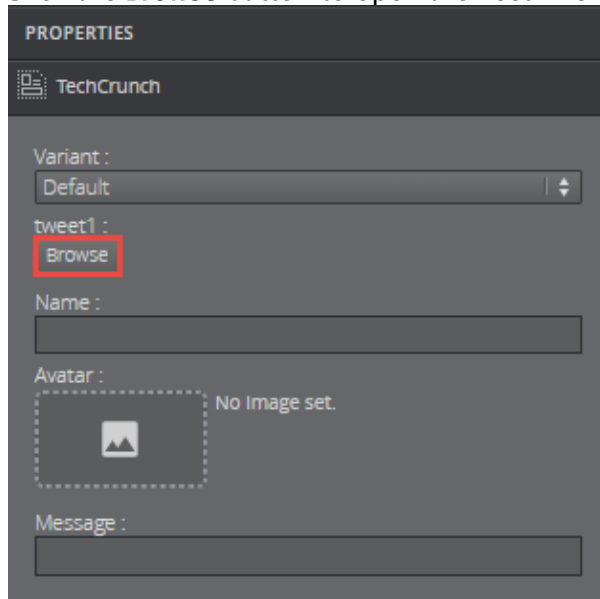

2. The Atom entries of the feed will be presented as thumbnails if available. Select one of the entries and click **OK**.

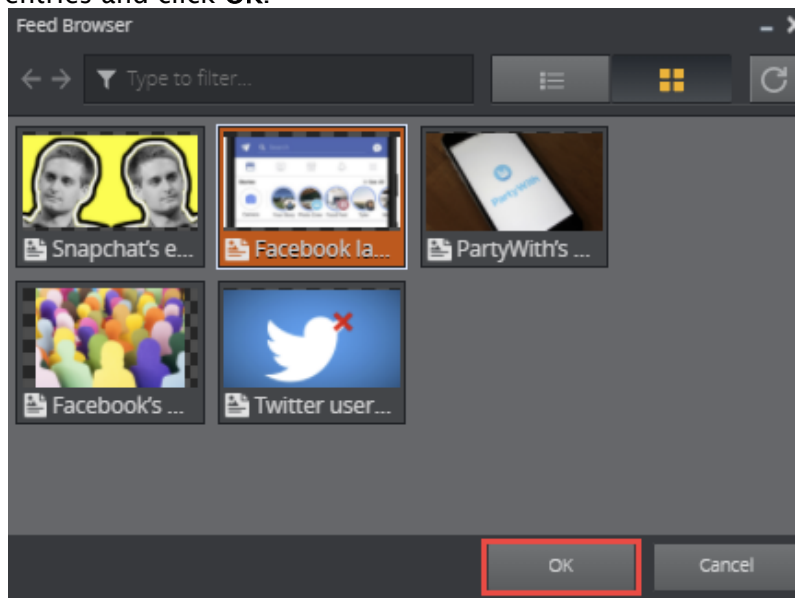

### 3. Information from the entry will be used to fill in the feed browser fields in the template.

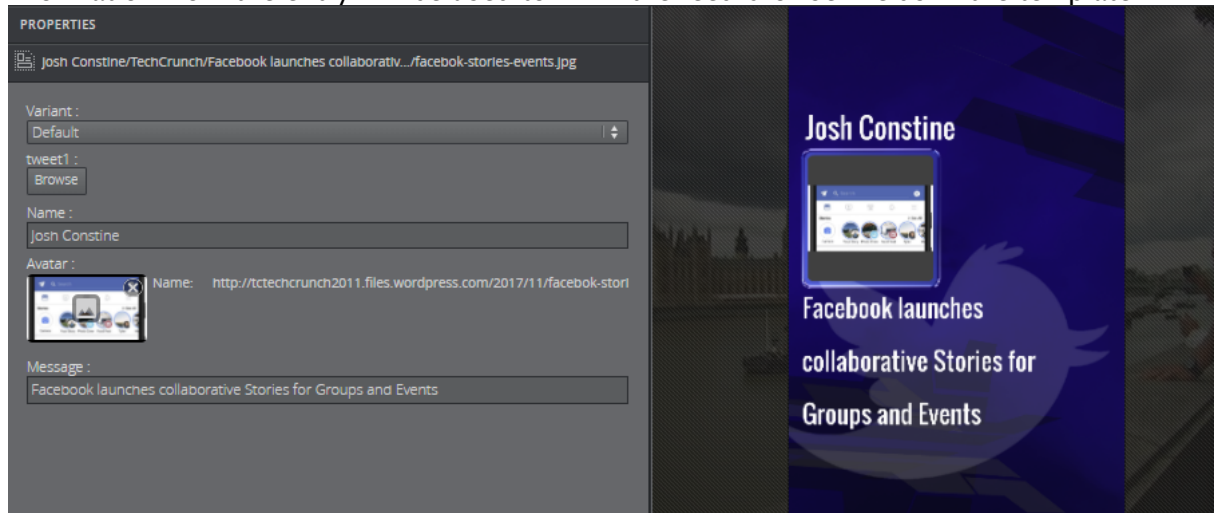

## Preview Window

The Preview Window displays snapshots of the graphics and provides the user with an idea of how the graphics will look when played out in high resolution on a Viz Engine. Viz Engine generates snapshots requested by Preview Server.

These are the functions of the Preview Window:

- **TA:** Show/hide the Title Area in the edit window.
- **SA:** Show/hide the Safe Area.
- **K:** Show the key signal for the graphics.
- **Preview points:** If the scene contains named preview points, such as stop points and/or tags in the director called **Default**, these are shown as buttons on the toolbar. If there is not enough space for the buttons, they appear in a drop-down list instead. Selecting a preview point shows a preview of the scene at the given point, and the playhead jumps to the point in time where the preview point is set.
- **Scrub** the timeline back and forth by clicking on it or moving the playhead. If the scene does not have a director called **Default**, or the Default director does not have a duration, the timeline will be disabled.
- **Auto-refresh:** Auto-refresh is located at the bottom of the Preview Window and is by default toggled on, which means that the Preview Window updates once there are any changes in the Fill In Form.

Toggle off **Auto-refresh** to turn this functionality off. To refresh the Preview Window in this

mode click the **Refresh** button  Auto-refresh :  or click inside the Preview Window.

- **Load:** Clicking this button will load the animation of the graphics. Once loaded, indicated by a green line at the bottom of the timeline editor, media controls appear allowing the

graphics animation to be controlled in the Preview Window:

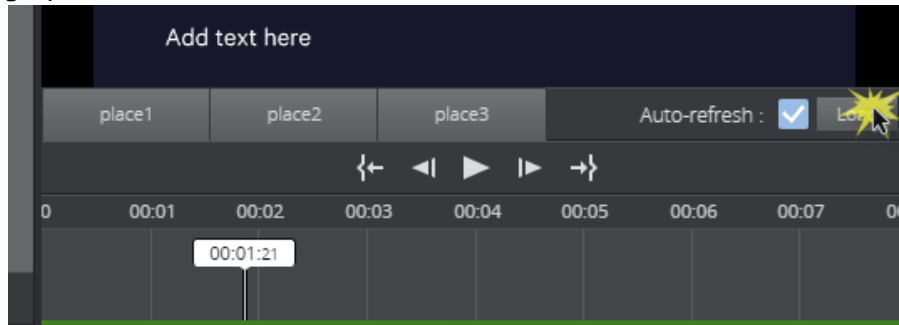

**Warning:** The load animation feature sends many snapshot requests to Preview Server. Many users sending requests at the same time could lead to performance issues.

## 4.12 Arming And Taking Elements

This section covers:

- [Media Pane](#)
- [Armed](#)
- [Program](#)
- [Arm and Take Multiple Elements](#)
- [Reload Scene](#)

### 4.12.1 Media Pane

- Elements that are ready are listed in the [Media Column](#), while the [Armed](#) and [Program](#) columns display elements currently armed or on air.
- [Arm and Take Multiple Elements](#) to manage multiple channels simultaneously.
- The [Using the Shortcuts Bar](#) is used to arm and take presets and other shortcuts.

**Note:** Adding videos to a graphics-only channel or graphics to a video-only channel will result in the element not being played out correctly. Composite elements will only work on channels that support both graphics and video.

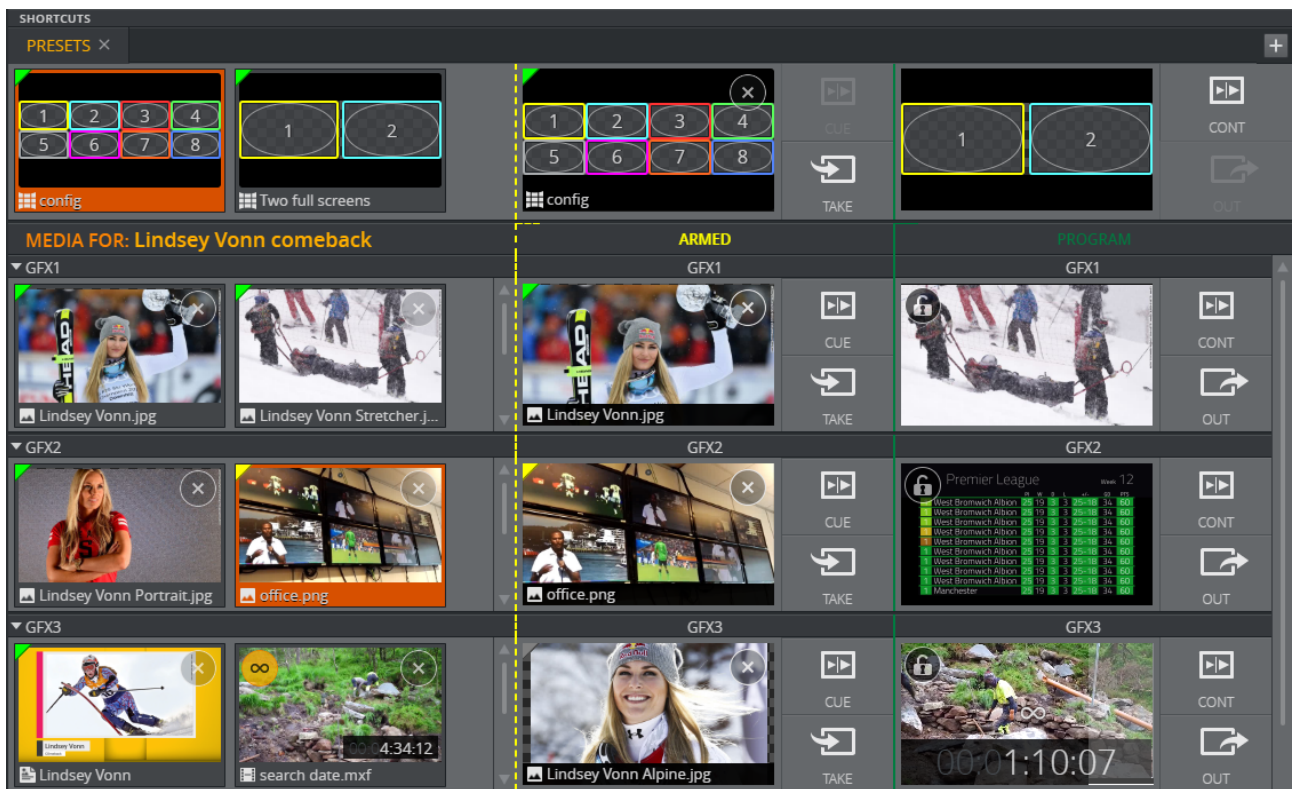

## Media Column

Elements that are ready to be played out are on the left. These elements belong to a page list or a playlist, and are assigned to one channel in the active profile.

**Note:** All changes made to elements in this column are reflected in Viz Trio.



This section covers the following topics:

- [Media Pane](#)
  - [Media Column](#)
  - [Options in On Air Mode](#)
  - [Shortcut Menu in the Media Column](#)
- [Armed](#)
  - [Armed Shortcut Menu](#)
- [Program](#)
  - [Visualizing Stop Points](#)
  - [Locking a Channel](#)
  - [Time Remaining](#)
- [Arm and Take Multiple Elements](#)
  - [Action Bar](#)
- [Reload Scene](#)
  - [Activating Reload Scene](#)

- [Using Reload Scene](#)
- [Tips to Use Reload Scene](#)

## Options in On Air Mode

With [On Air Mode](#) enabled, you can prepare (arm) and play out elements. Either:

- **Right click** an element to use the context menu.
- **Click** an element to move it to [Armed](#).
- **Drag** an element to Armed or Program in another channel to make a copy there (the original remains in the source channel).
- **Drag** an element to the Media Column in another channel (this removes the element from the source channel).
- Turn **Looping** ON  or OFF .

 **Note:** You cannot change the looping setting once the clip is playing. Take out the clip to stop looping.

- **Delete** an element with **X** button or **Remove** from the context menu.

 **Note:** Show or hide the **X** button in the General tab in Settings.

A thumbnail indicates that the element is still **loading**:

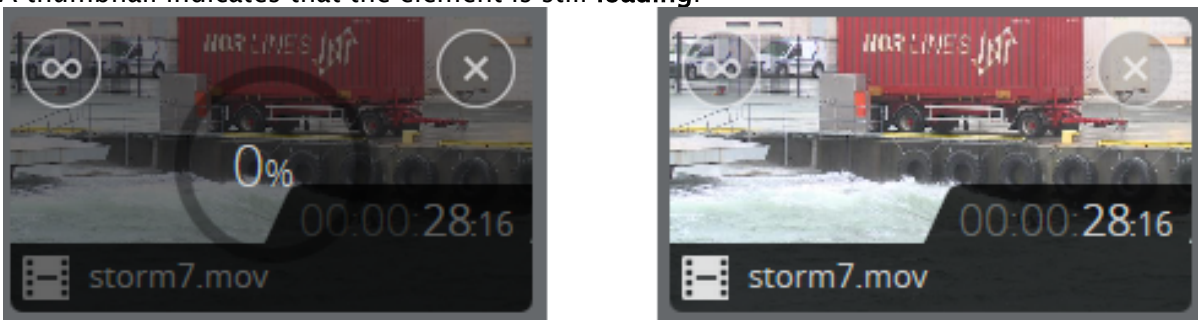

In [1-Tap Mode](#), you can click an element to move it directly to [Program](#).

When elements have been selected in several channels (one element per channel):

- **Arm Selected:** Send all selected elements to [Armed](#).
- **Take Selected:** Send all selected elements to [Program](#).

## Shortcut Menu in the Media Column

Right-click elements (videos, images and graphics) in channels in the Media Column to open the menu:

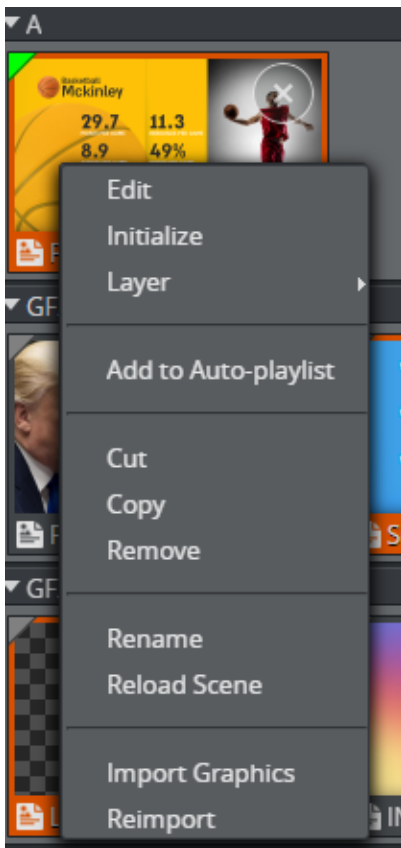

- **Initialize:** Loads the resources of this element into the memory of the renderer. Initialize is available for images and graphics and ensures instant Take payout.

**⚠ Caution:** Initialize may disrupt animations or clips playing on the renderer. It is recommended to initialize before the broadcast starts, or when there is low activity on the renderer.

The **colored triangle** in the top left corner of the element shows whether the resources are loaded on the renderer. Green is loaded, yellow is loading, and gray is unloaded.

**⚠ Note:** If the element is not loaded, there may be a delay before the renderer plays the graphics when a Take is executed.

- **Layer** (non-GFX channels only): Set the Viz layer (FRONT, MAIN or BACK).
- **Add to Auto-playlist:** Only media elements from the same group can be included on an Auto-playlist.
- **Reload Scene:** From Graphic Hub.

**⚠ Note:** Reload Scene is only visible when right-clicking graphics in the media, armed and program columns. See [Reload Scene](#).

- **Import Graphics:** Import graphics directly from Viz Graphics Hub into the channel.
- **Reimport** (only for graphics): Reimport the graphics from Graphic Hub. Does not affect the renderer. Useful if the scene designer has added or removed control fields.

## 4.12.2 Armed

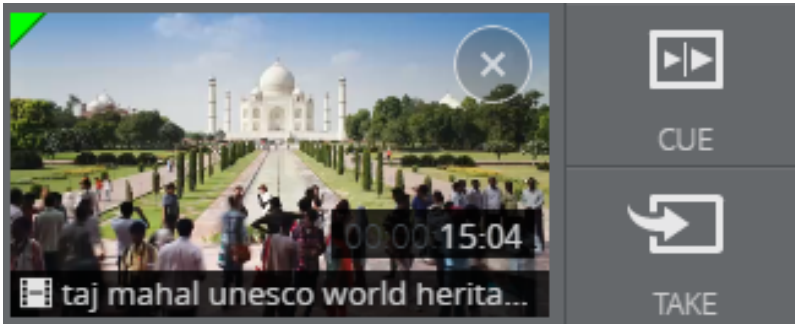

When armed in Arm and Fire video wall configuration, elements get prepared on Viz Engine for playout. The **green triangle** shows that the renderer is ready and the element can be played out instantly.

In legacy video wall configurations only clips are prepared on Viz Engine.

The following actions are available in the Armed column:

- Click an element to take it to [Program](#).
- Click the **TAKE** button to take the element to [Program](#).
- Click the **CUE** button (enable this in Settings) to send the element to [Program](#) in the first frame in the renderer ready to be played out.
- Click the **CONTINUE** button (enable this in Settings) to continue the graphics or video on the external preview engine. Only available if external preview is used.
- Click the **SWAP** button (enable this in Settings) to swap the content in the Armed column and the Program column.
- Drag an element to [Armed](#) or [Program](#) in another channel to make a copy there (this does not affect or take the original armed element).
- **Take All**: Send all armed elements, for all channels, to [Program](#).
- **Cue All**: Send all armed elements, for all channels, to [Program](#) in the first frame in the renderer ready to be played out.
- **Swap All**: Swap all elements in the armed column with the elements in the Program column.
- See the **Looping** status of the video.

**⚠ Note:** The looping setting cannot be changed in the Armed column. Use the looping button in the Media column.

- **Remove** an element from the Armed column by clicking **X**.

### Video wall main channel:

In Arm and Fire configuration, if a preset is armed on the main channel ("A") the preset thumbnail will show every armed element on that video wall. Clicking **TAKE** on the main channel in this case will play out all armed element on this video wall.

## Armed Shortcut Menu

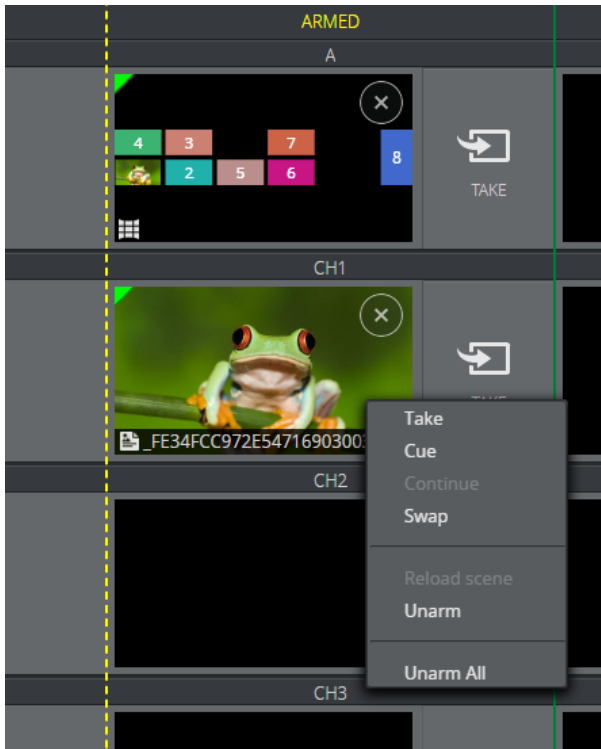

- **Take:** Take the Armed element to Program.
- **Cue:** Send the element to Program in the first frame.
- **Continue:** on the external Preview renderer. Only enabled if an external preview is configured for a video wall.
- **Swap:** Swap the content in the Armed column and the Program column.
- **Reload scene:** Shows the new updated scene.
- **Unarm:** Remove element from Armed.
- **Unarm All:** Remove all elements from Armed.

### 4.12.3 Program

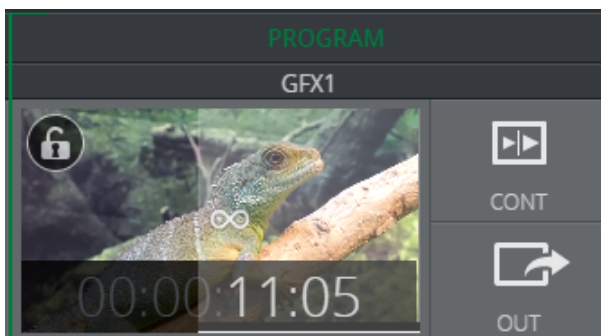

Elements shown in the Program column are currently playing on air in the channel.



**Note:** With Media Sequencer version 5.0 or higher, the Program column will not only show the last taken element, but snapshots of all the layers that are in the renderer at a given moment. This means that when a Transition Logic layer is taken in (for instance a banner), and another layer is taken in (for instance a clock or a side panel), the Program column will actually show both of these layers, and not only the last taken element.

- Click **CONT** to continue a graphic element or Cued elements.
- Click **OUT** to take out the element.

**Note:** With Media Sequencer version 5.0 or higher, **OUT** takes out content on all layers in the renderer, including Transition Logic layers, and not only the last taken element.

**Important:** **OUT** will not be enabled for a main or shortcut channel that has a video wall preset on air. A preset should always be on air when operating a video wall, even if the channels are empty. The preset ensures that content can always be played out directly in the channels on the wall.

- **Drag** an element to **Armed** or **Program** in another channel to make a copy there (this does not affect the original program element).
- **Continue All:** program elements in all channels, including cued elements.

**Important:** **Continue All** will not continue elements in the Shortcuts Bar. Only elements in regular channels visible in the interface (including collapsed channels) are affected. Channels hidden by the active Workspace are not affected.

- **Out All:** Take Out all program elements in all channels.

**Important:** **Out All** will not take out elements in the Shortcuts Bar. Only elements in regular channels that are visible in the GUI (also collapsed channels) are affected. Channels hidden by the active Workspace are not affected. **Out All** has a fail-safe that provides an extra confirmation step when clicked.

- See the **Looping** status of the video.

**Note:** The looping setting cannot be changed when the clip is playing. To stop looping, take out the clip and toggle the looping **OFF** in the Media column.

- **Display a snapshot** of the clip/graphic (clips can also play depending on the setting **Play videos locally in Program** in **Settings**).

**Note:** The preview shown in the Program column is an indication only and may not be completely in sync with the actual output.

### Video wall main channel:

If channel state is enabled, the main channel ("A") will show the preset thumbnail with every element being played out on that video wall.

## Visualizing Stop Points

If a graphics imported with Viz Multiplay in the GFX playlist has stop points, this will be visualized in the Program column on the thumbnail:

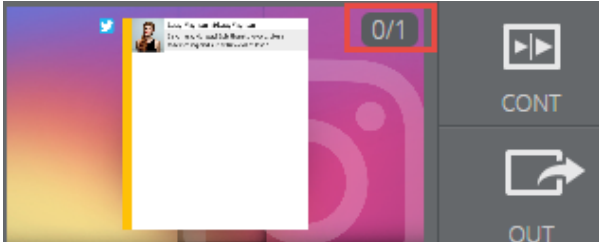

The number will indicate the current stop points and how many stop points the graphics has.

## Locking a Channel

Each Program channel has a **lock symbol** (enabled in settings) to hinder any changes being made to it.

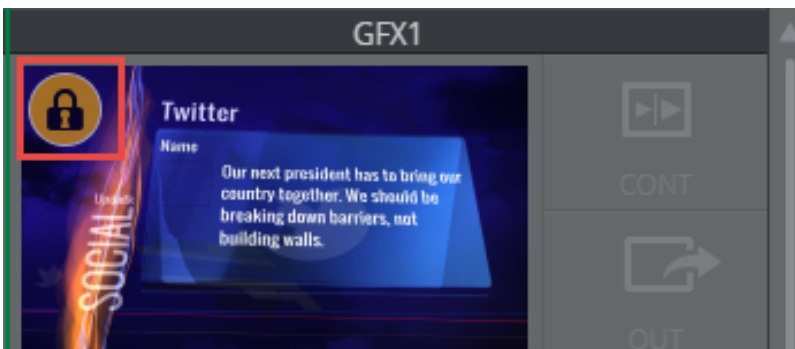

You can lock a channel if it is to stay on air. The **Continue** and **Out** and **Out All** and **Continue All** buttons will then be disabled. A common use case can be to lock some channels, and click **Continue All**, only the unlocked channels will receive the Continue command.

**Note:** The lock only applies the local client. Other Viz Multiplay clients can still change the content of the channel.

## Time Remaining

The time remaining for a clip is indicated with a **gray** progress bar. **Orange** shading indicates <20 seconds remaining, and red indicates <10 seconds remaining. Only the gray progress bar is shown on looping clips.



#### 4.12.4 Arm and Take Multiple Elements

##### Action Bar

**Note:** The Action Bar is hidden in Off Air Mode.

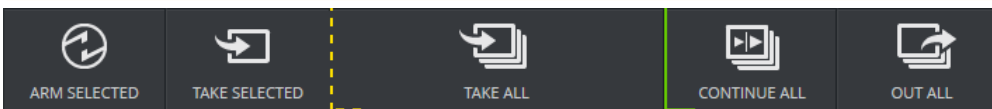

- **Arm Selected:** Send all selected elements in the **Media Column** to **Armed**.
- **Take Selected:** Send all selected elements in the **Media Column** directly to **Program**.
- **Take All:** Send all **Armed** elements, for all channels *and shortcuts*, to **Program**.
- **Continue All:** Continue all **Program** elements, in all channels.
- **Out All:** Take Out all **Program** elements, in all channels.

**Note:** The **Using the Shortcuts Bar** is unaffected by **Continue All** and **Out All**.

#### 4.12.5 Reload Scene

Update On Air graphics with the reload scene option. This feature is useful when changing scenes on the fly in Viz Artist and quickly taking them to air.

##### Activating Reload Scene

Right-click a graphic in the media pane (shown below) or in the armed or program columns.

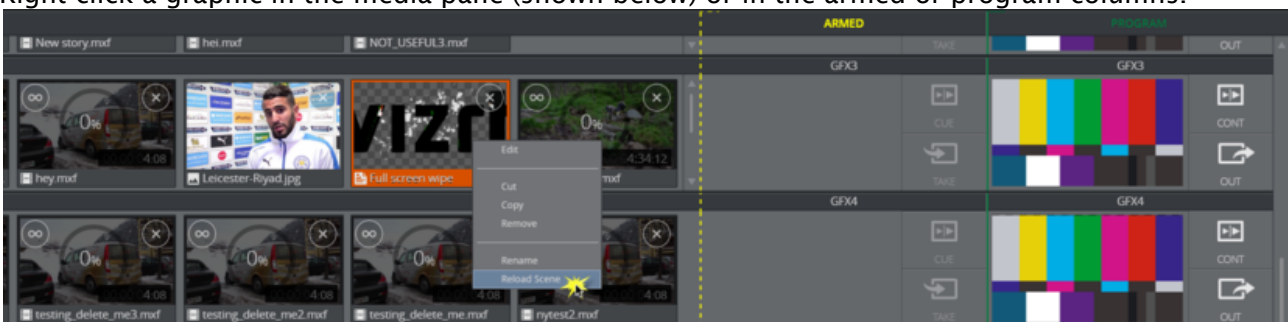

## Using Reload Scene

A graphic is showing live on a video wall. As the graphic is in use, a scene designer changes it in Viz Artist.

Bring the changes to air:

1. Send a graphic to air in the program column.
2. The scene, which is now in use on a video wall, is opened in Viz Artist and changed by a scene designer. The new scene is saved in Graphic Hub.
3. Right-click the graphic in the program column of the channel where the graphic is playing out and click **Reload Scene** to show the new, updated scene.

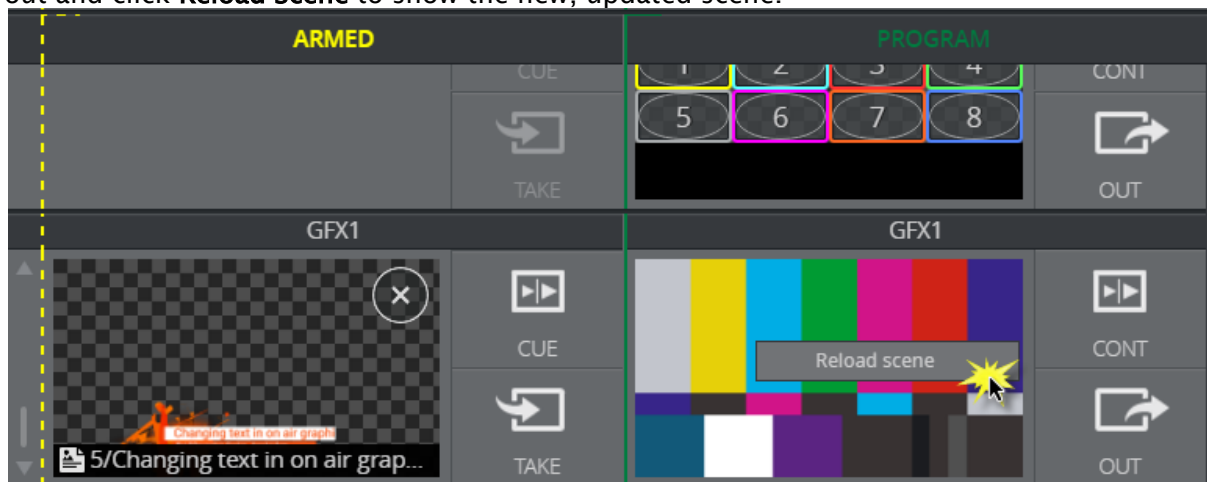

### Tips to Use Reload Scene

Scenario	Solution
Default data is inserted into an On Air graphic's editable field after clicking <b>Reload Scene</b> . This only applies for graphics with a payload editor, not for, for example, graphics such as a bug.	Once a graphic is ready to be reloaded, take it out from the program column. Locate it again in the relevant channel in the media pane and click <b>Reload Scene</b> . You can now send it to air with the new changes.

## 4.13 Organizing Shows And Playlists

This section contains the following topics:

- [Browse Shows Window](#)
- [Show Pane](#)
- [Locating Page Lists, Playlists and Groups](#)
- [Add, Delete or Rename a Group](#)
- [Move Groups to Other Playlists in the Show Pane](#)
- [Add a New Playlist](#)

- [Working with Playlists](#)

### 4.13.1 Browse Shows Window

Click the **Open** button on the [Toolbar](#) to open the Browse Shows Window.

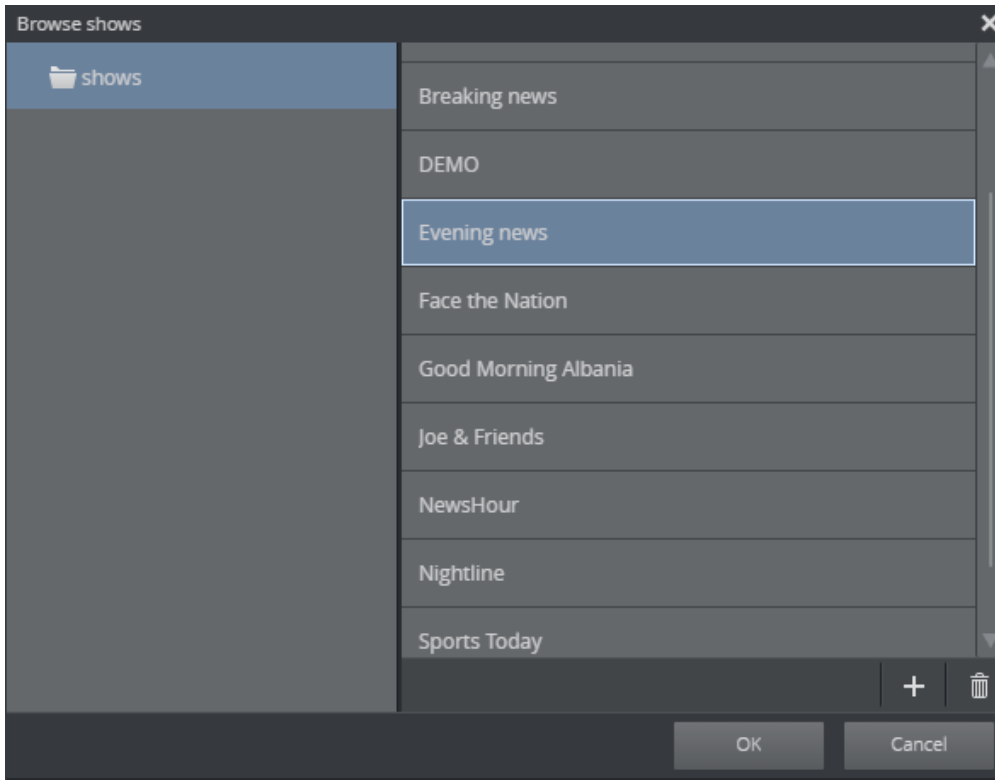

Open or delete existing **shows** or create new shows. Rename a show by selecting it and pressing **F2**. Select a show to open it in the [Show Pane](#).

### 4.13.2 Show Pane

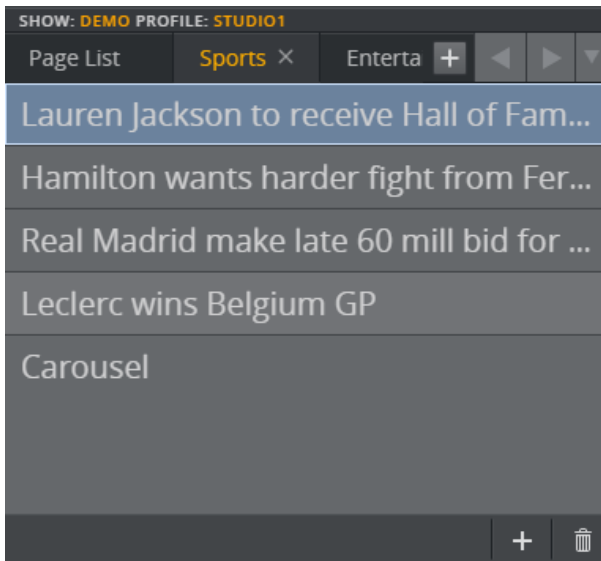

The Show pane at the top left of the main window displays the playlists and groups that are part of your show and connected to a certain profile. The **Page List** contains the name of the show, the other tabs are playlists.

### 4.13.3 Locating Page Lists, Playlists and Groups

Each tab contains Groups (3), and each group contains the media elements for a story. Select a group to load related media elements into the [Media Column](#).

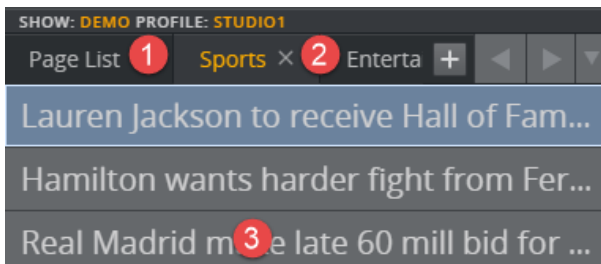

#### 4.13.4 Add, Delete or Rename a Group

##### Add a New Group to the Bottom of the List of Groups

1. Click **Add (+)** at the bottom of the show pane:

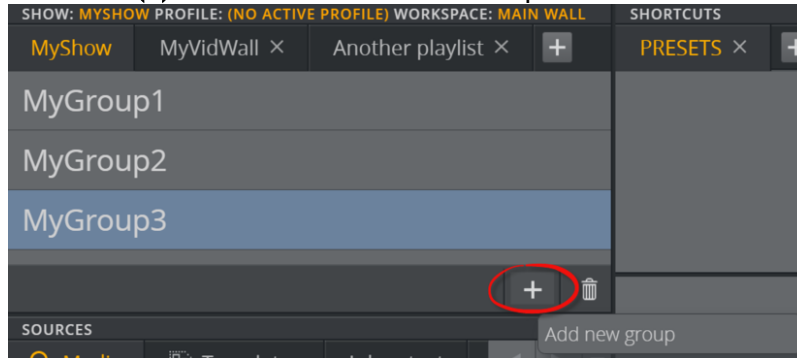

2. Give the group a name and press **ENTER**.

##### Insert a Group into a Specific Spot in the List of Groups

1. Right-click a group and select **Insert new group** from the shortcut menu.

**Warning:** The new group will be inserted directly above the group you right-click.

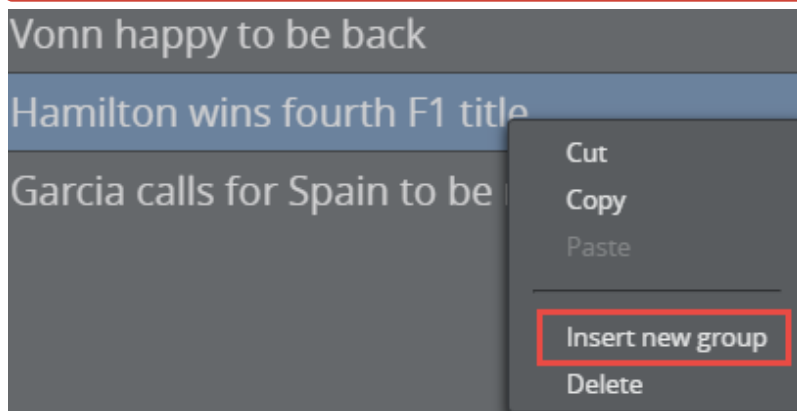

2. Give the new group a name and press **ENTER**.

## Delete a Group from the Show Pane

1. Right-click a group and select **Delete** from the shortcut menu, or Click the trash can icon at the bottom of the show pane.

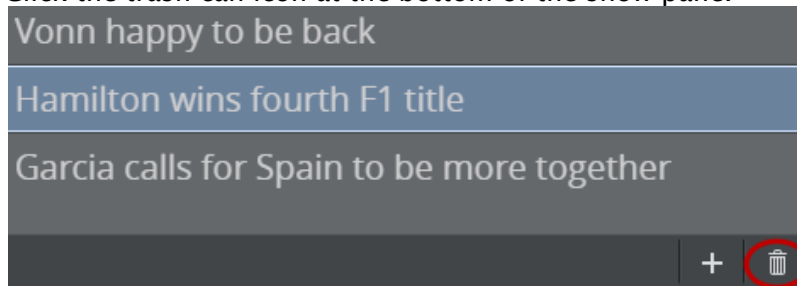

2. Click **Yes** when prompted.

## Rename a Group

1. Double-click a group.
2. Enter a new name.
3. Press **ENTER**.

✓ **Tip:** Groups can also be created and modified in Viz Trio.

### 4.13.5 Move Groups to Other Playlists in the Show Pane

Move a group by dragging, with a copy/paste operation using standard Windows keyboard shortcuts or via a group's shortcut menu.

#### Workflow Examples

Drag a group to another playlist tab:

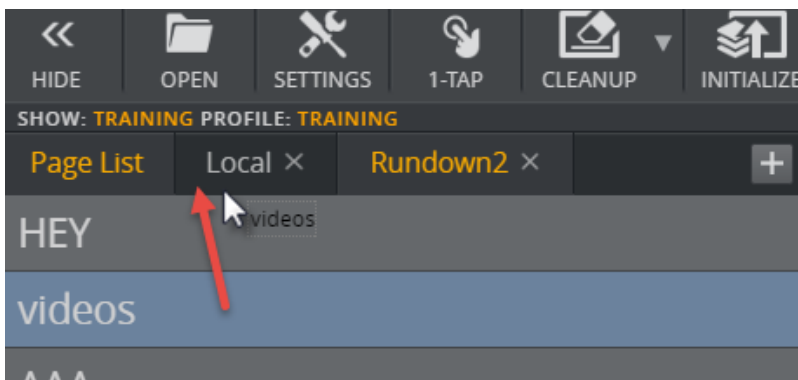

You can also move a group using **CTRL + C** and **CTRL + V** or the shortcut menu:



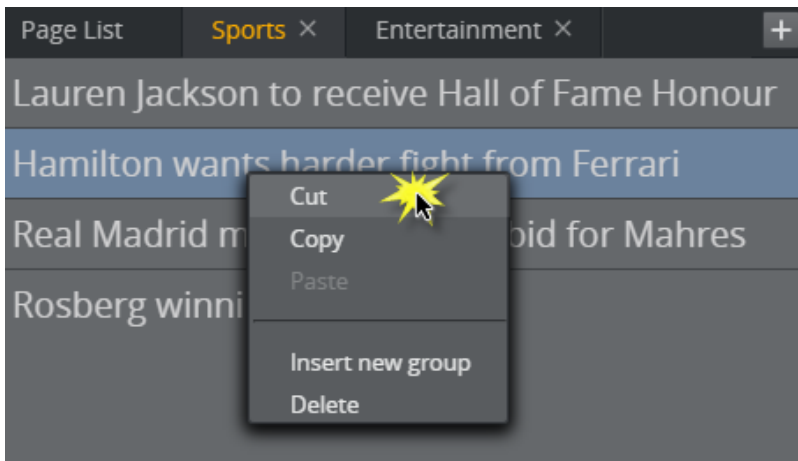

### 4.13.6 Add a New Playlist

1. Click **Add (+)** to create a new playlist or open an existing external playlist.

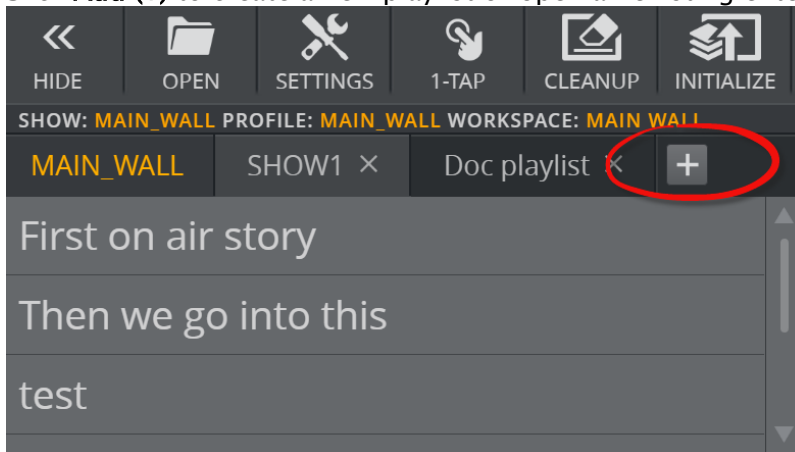

- a. **Create new playlist:** The playlist will be owned by the show and appear as a tab in the Show pane but will not be visible in the show/playlist directory tree.

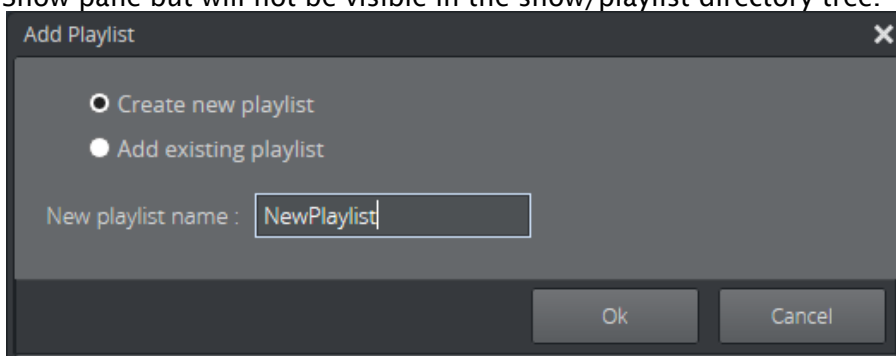

- b. **Add existing playlist:** Open existing playlists from Viz Pilot or other newsroom systems.

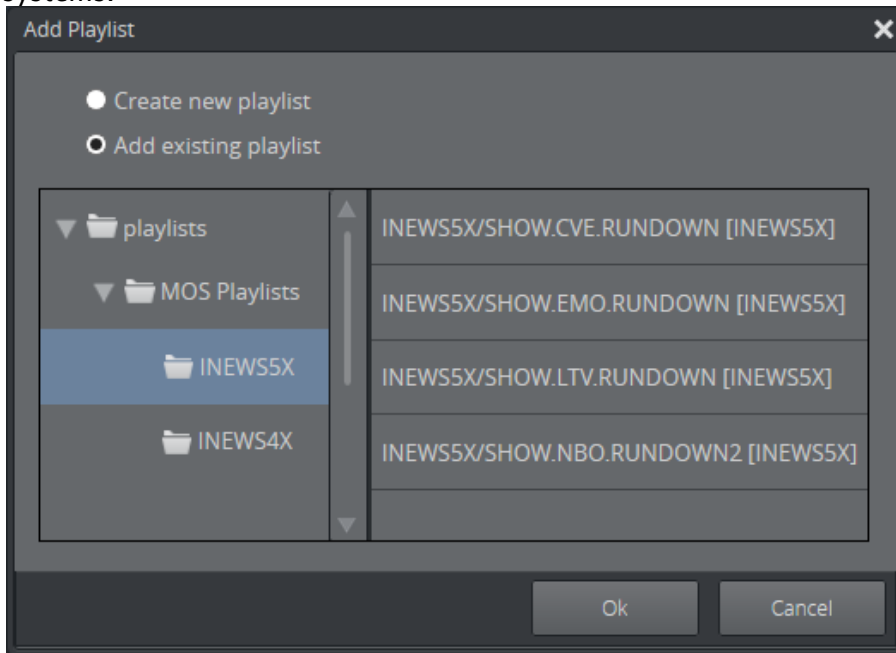

- 2. Click **X (Close)** to delete an internal playlist or remove the reference to an external playlist.
- 3. Click **Ok**.

✔ **Tip:** Playlists can also be created and modified in Viz Trio.

### 4.13.7 Working with Playlists

#### Rename a Playlist

- 1. Double-click the playlist title.

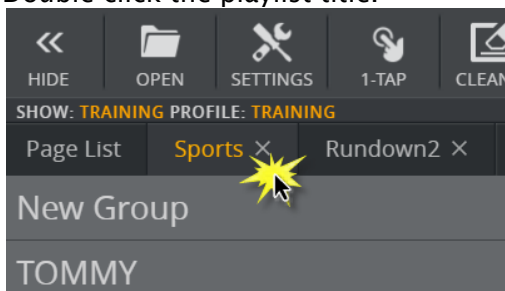

- The title field becomes editable.

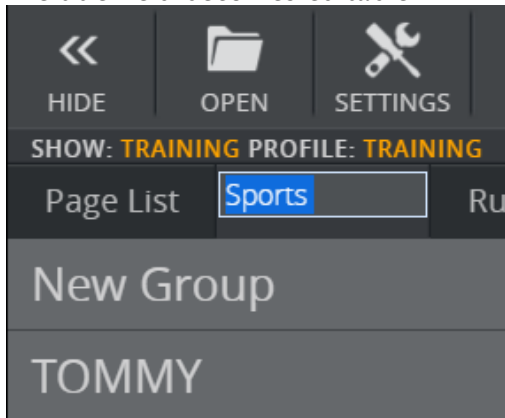

- Enter a new title in the field and press **ENTER** to confirm.

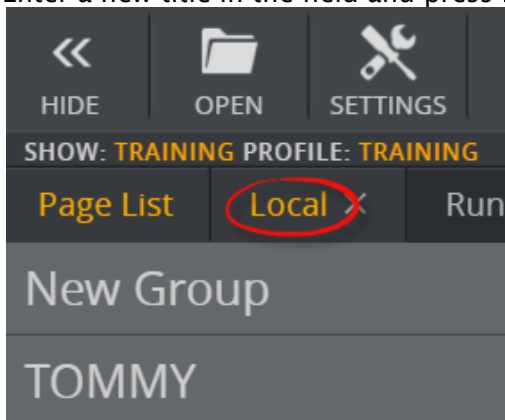

### Re-position a Playlist

- Click and drag the playlist to the desired position in the top menu.

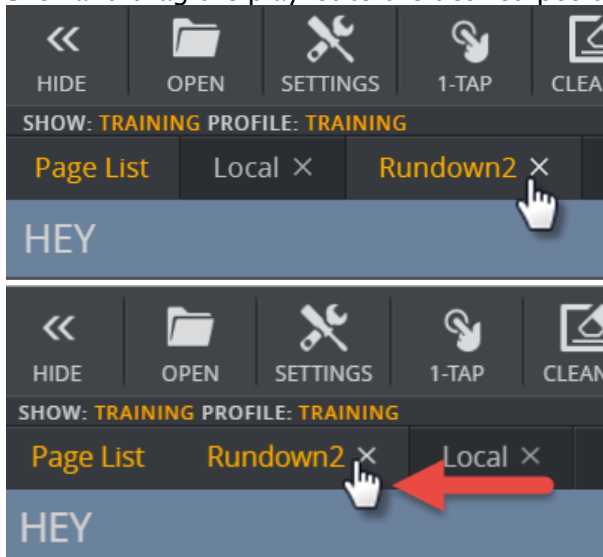

## 4.14 Using The Shortcuts Bar

The Shortcuts Bar gives fast access to frequently used elements, such as video wall presets, graphics, backgrounds or videos.

This section covers the following topics:

- [Elements in the Shortcuts Bar](#)
  - [Keyboard Shortcuts](#)
  - [Context Menus](#)
- [Layers](#)
- [Working with the Shortcuts Bar](#)
  - [Adding a Shortcuts Group](#)
  - [Deleting a Group from the Shortcuts Bar](#)
  - [Renaming a Group](#)
  - [Re-positioning a Group in the Shortcuts Bar](#)
- [Reveal Extra Information on Thumbnails](#)



**Note:** The Shortcuts bar is technically a playlist within the show. The content from this playlist is only available within the show in which the playlist is created.

A playlist is set as the Shortcuts bar by selecting it in **Settings > General Tab > Shortcuts**.

You can have **multiple tabs** of shortcuts to make it easy to access items that are used frequently, independent of which story you are working on. Each group in the Shortcuts bar playlist appears as a tab in the Shortcuts bar. The shortcuts are specific to a show so that when you change your show you can have different shortcuts for different productions.

**Note:** It is also possible to have shortcuts tab per workspace. This means that two workspaces can have different shortcuts. See [Workspaces](#).

### 4.14.1 Elements in the Shortcuts Bar

Any type of element can be placed in the Shortcuts Bar, but note that this section of Viz Multiplay does not act as an individual channel, elements in the Shortcuts bar need to explicitly have an assigned channel to them. They will then arm and play out on their respective channel when clicked. Note that the Arm and Program column for the ShortcutsbBar only displays the last armed

or taken element, these columns do not accurately reflect the content on any output channel. These are some of the playlist element types that may be in the Shortcuts Bar:

- **Presets:** [Presets](#) define the layout of the channels on a video wall. When a new preset is taken to air, it triggers a transition from the current layout to the new layout. New presets are created using the [Designing Video Walls](#).
- **Filled Presets:** A [Filled Preset](#) is a preset which also includes content. When a filled preset is taken to air, it populates the preset with content and plays out everything at once. Presets are filled with content using the preset content editor.

**Note:** If a video wall group is partly filled, the empty GFX channels will continue to contain the old content.

- **Backgrounds:** Basic elements which load different scenes into the Back layer of the video wall Engine. They need to be pre-assigned to the right channel and the right Viz layer so that they run in the back layer (this can also be set in the scene in its control object plugin).
- **Elements:** Images, videos and graphics.

Items in the Shortcuts Bar can be armed by clicking them, similar to arming channels.

**Show or hide** the Shortcuts bar by selecting a Shortcuts playlist in the **General Tab** of the Settings window.

## Keyboard Shortcuts

A keyboard shortcut can be assigned to any playlist element in the Shortcuts bar. Right click the playlist element and select **Set Take Shortcut** on the context menu:

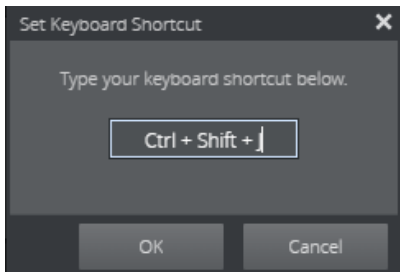

Now either press your keyboard shortcut or delete the content to clear an existing keyboard shortcut. Note that the browser may override some shortcuts, so pick your keyboard shortcuts carefully.

The keyboard shortcuts are stored in the local browser, so they are private per instance of Viz Multiplay and exclusive per show.

To see an overview of keyboard shortcuts for the Shortcuts bar in this show, click the Shortcuts

button on the toolbar  .

The **TAKE Command Shortcut Keys** tab will then display a list of assigned keyboard shortcuts in this show:

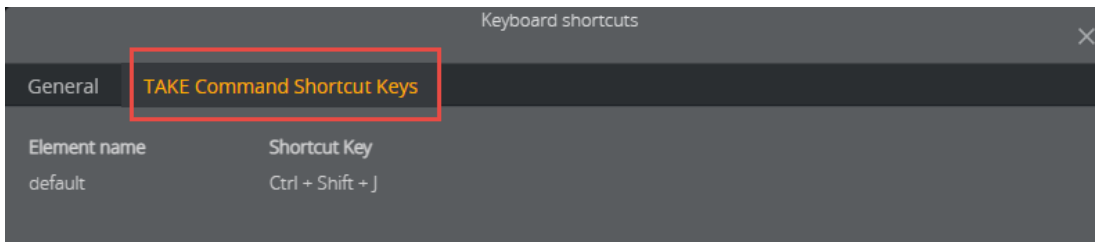

## Context Menus

Access two context menus by right-clicking elements in the Shortcuts Bar. The options in each menu change depending on the type of media you are right-clicking.

- [Shortcut Menu for Presets](#)
- [Shortcut Menu for Elements](#)

## Shortcut Menu for Presets

Right-click a preset in the Shortcuts Bar to expose the following context menu:

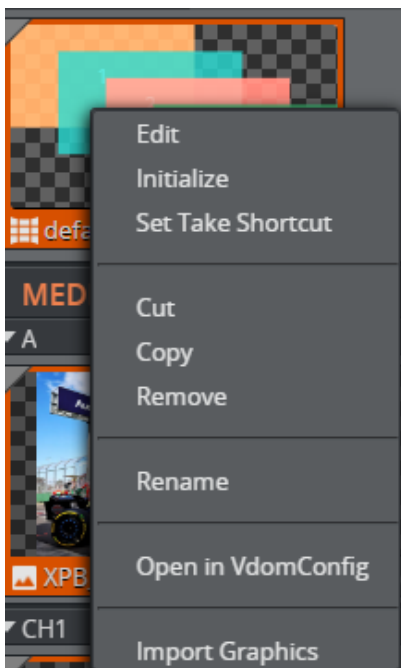

- **Edit:** Open the Preset Content Editor.
- **Initialize:** Load the preset scene on the renderer.
- **Set Take Shortcut:** Set a keyboard shortcut for taking this preset.
- **Cut:** Cut a preset and paste it in another tab/column.
- **Copy:** Copy a preset and paste it in another tab/column.
- **Paste:** Paste an element previously copied or cut.
- **Remove:** Remove the preset from the Shortcuts Bar.
- **Rename:** Rename the preset.

- **Import graphics:** Import graphics from the Graphic Hub directly into this group.

## Shortcut Menu for Elements

Right-click an element (graphics, images or clips) in the Shortcuts bar to expose the following context menu:

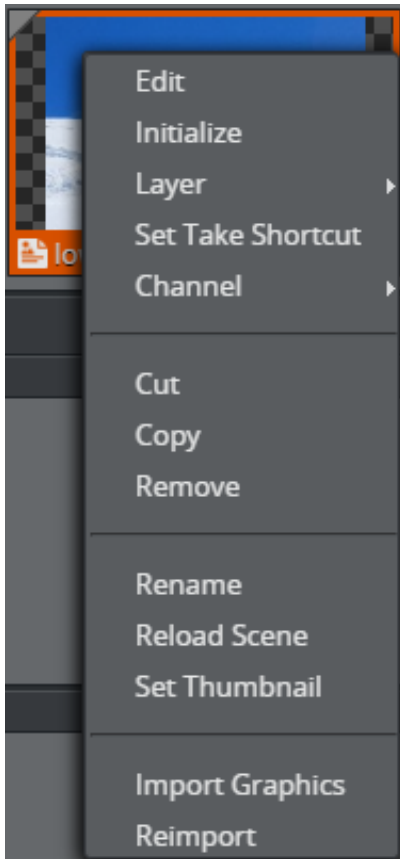

- **Edit:** Open the corresponding element editor.

**Note:** The image editor is only available for images assigned to a GFX channel.

- **Initialize:** Load the resources for this element into the renderer. Should be used with care. It may affect renderer performance.
- **Layer:** Change the Viz Engine layer (BACK, MAIN, FRONT). See [Layers](#).
- **Set Take Shortcut:** Set a keyboard shortcut for taking this element.
- **Channel:** Change the playout channel of the element
- **Cut:** Cut a shortcut element.
- **Copy:** Copy a shortcut element.
- **Paste:** Paste a playlist element.
- **Remove:** Remove the element from the Shortcuts bar and delete it.
- **Rename:** Rename the element.
- **Reload Scene** (only for graphics): Makes the renderer reload the scene from the Graphics Hub.

- **Set Thumbnail:** Set a custom thumbnail for the element.
- **Import graphics:** Import graphics from the Graphic Hub directly into this group.
- **Reimport** (only for graphics): Re-import the graphics from the Graphic Hub. Does not affect the renderer. Useful if the scene designer has added or removed control fields.

## 4.14.2 Layers

Use different layers to show up to three elements on screen simultaneously (only for main renderer and classic scenes). Play elements in the default, FRONT, MAIN and BACK layers (defined below).

The selected layer will determine the element's Z-position in relation to other elements.

- **default:** Revert to the layer that is set by the scene designer.
- **FRONT:** Front layer elements cover main and back layer elements, this layer will never be obstructed.
- **MAIN:** The middle layer used to play out the presets in Multiplay.
- **BACK:** The layer that can be used as a background for a videowall.

## 4.14.3 Working with the Shortcuts Bar

### Adding a Shortcuts Group

Add a group to the playlist you have chosen to appear in the shortcuts bar. Groups created via the shortcuts bar appear in the show pane when no shortcut playlist is set.

1. Click the **Add (+)** button in the Shortcuts Bar.



2. Give the new group a title.
3. Click **OK**.

### Deleting a Group from the Shortcuts Bar

Delete playlist groups from the shortcuts bar.



1. Click the close button in the top right corner of the shortcut group tab.

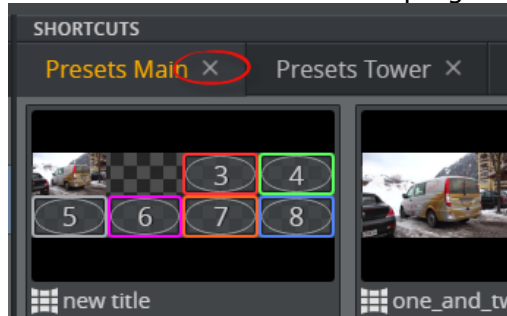

2. Click **Yes**.

## Renaming a Group

1. Double-click the group's title.

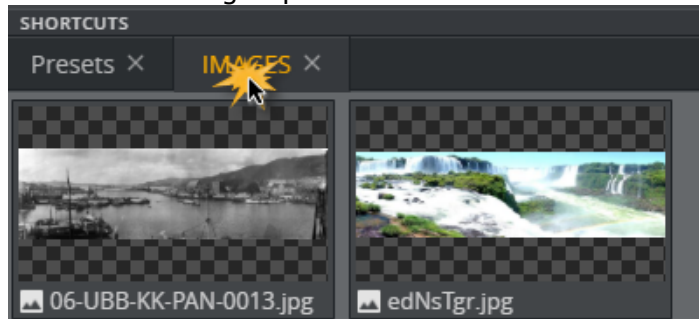

2. The title field becomes editable.
3. Enter a new title in the field and press **ENTER** to confirm the change.

## Re-positioning a Group in the Shortcuts Bar

Click and drag the group to the desired position in the top groups.

### 4.14.4 Reveal Extra Information on Thumbnails

Pressing and holding **SHIFT** at any time will reveal more information on top of the thumbnails in the Viz Multiplay UI:

- Which main channel your presets are playing out on.
- Which Output channel an item in a filled preset is playing out on.
- The title of an element in the Program column.

Release **SHIFT** to hide the information again.

---

## 5 Appendix

This appendix contains the following sections:

- [FAQs](#)
  - [Glossary](#)
  - [Troubleshooting](#)
- 

### 5.1 FAQs

- [What is the Technical Limitation of Playing HD Clips?](#)
- [Does the Playlist Update after Changes in the Newsroom System Rundown?](#)
- [Can Viz Multiplay Payout Graphics Created via Viz Pilot Templates?](#)
- [Can Viz Multiplay Open a Playlist from Viz Pilot?](#)
- [Can Viz Multiplay Open a MOS Rundown? What is the workflow?](#)
- [Can We Have Live Input in One of the Monitors or Across a Group?](#)
- [Can Viz Multiplay be Controlled by Viz Mosart, VDCP, Viz Trio or Viz Pilot?](#)
- [Can Viz Multiplay be integrated into a Viz Mosart Workflow?](#)
- [Do I need a Viz One to Feed Viz Multiplay with Clips and Images?](#)
- [Does Viz Multiplay Support Stream Deck?](#)

### Do I need Viz Trio or Viz Pilot to set up Viz Multiplay?

No. Viz Multiplay can do basic import of graphics from Media Sequencer. It does not support concepts/variants nor Transition Logic though.

#### 5.1.1 What is the Technical Limitation of Playing HD Clips?

The technical limitation of the number of channels is 16, depending on the video board. The performance when playing a number of clips is dependent of lot of different factors, like the hardware and the clip codecs and formats. Real life tests should always be conducted before going into production.

#### 5.1.2 Does the Playlist Update after Changes in the Newsroom System Rundown?

Yes. It is Media Sequencer that communicates through the MOS protocol with the newsroom system (ENPS, iNews etc.). Any update is handled by Media Sequencer, and the playlist in Viz Multiplay will automatically display the changes.

### 5.1.3 Can Viz Multiplay Playout Graphics Created via Viz Pilot Templates?

Yes. Create a Viz Pilot rundown with the graphics, images and videos you want to playout. The playlist will automatically be available in Viz Multiplay.

### 5.1.4 Can Viz Multiplay Open a Playlist from Viz Pilot?

Yes. Add the playlist to the show with the Add button on the Show pane. Once open in Viz Multiplay, the playlist updates dynamically, as it is changed in Viz Pilot.

Click the **Add (+)** button in the [Show Pane](#) to open an existing external playlist.

### 5.1.5 Can Viz Multiplay Open a MOS Rundown? What is the workflow?

Yes, you can add any external playlist to the show, so both the show and the added playlist(s) are available in Viz Multiplay. In this way the user can, for example, have a show with video wall presets and other more permanent elements, and add a MOS rundown or a Viz Pilot rundown to this show to make the MOS/Viz Pilot elements available too.

### 5.1.6 Can We Have Live Input in One of the Monitors or Across a Group?

Yes. Custom scenes with a live input source must be created in Viz Artist and imported in Viz Multiplay. These pages can for instance be placed in the inbox show and then dragged into any channel.

### 5.1.7 Can Viz Multiplay be Controlled by Viz Mosart, VDCP, Viz Trio or Viz Pilot?

There is currently limited support for this workflow. Viz Multiplay is designed to be controlled by an operator through the user interface.

### 5.1.8 Can Viz Multiplay be integrated into a Viz Mosart Workflow?

Yes. It requires some manual steps. It is possible to create video wall presets in Viz Multiplay and play them out as Pilot elements in a Viz Mosart rundown. Contact Vizrt Support for more information.

### 5.1.9 Do I need a Viz One to Feed Viz Multiplay with Clips and Images?

We recommend having a Viz One or a Media Service installed and configured on Media Sequencer. It is also possible to use a Graphic Hub REST service as a source for images.

### 5.1.10 Does Viz Multiplay Support Stream Deck?

Indirectly yes. Set up keyboard shortcuts in Viz Multiplay and assign them to keys on Stream Deck.

---

## 5.2 Glossary

The following terms are used in this manual:

- **Arm:** Armed means that an element is ready for play-out. When 1-tap mode is off, elements are sent to the **arm column**.
  - **Channel:** One or more Viz Engine connections. Typically either a Viz output, a video output, or both.
  - **Channels:** Each wall contains one main channel and multiple additional channels that can be freely moved and resized. Channels contain images, videos or Viz Artist scenes.
  - **Layout:** A unique arrangement of channels within a preset. You can save multiple layouts for a show and design layouts for a specific look (for example a morning and evening show). Layouts can be used by more than one preset.
  - **Main channel:** The Viz output on which video wall presets are run. This is normally host:6100. Only presets and backgrounds should be taken on this channel.
  - **Preset:** A pre-defined set of one or more layouts of channels on a video wall, used to create a specific look, for example a breakfast show. Presets are Viz Artist scenes played out on the main channel.
  - **Profile:** A defined set of playout channels and video walls.
  - **Show:** A Viz Trio compatible data structure on the Media Sequencer that describes a set of elements (graphics, videos, images) and playlists.
  - **Superchannel:** An abstraction layer containing graphics, clips, streams, live content, etc. With Superchannels, content in each channel can be played out in an A/B workflow.
  - **Video wall:** The physical layout of a display or set of screens. Each wall belongs to a single profile. The layout (rows, columns, screen dimensions, bezels) must match the NVIDIA Mosaic setup.
  - **Workspace:** The user interface that can be customized for each individual user. For example, you can hide channels that are not needed by an anchor.
- 

## 5.3 Troubleshooting

This section covers the following topics:

- [The Viz Engine Output Keeps Going Black Randomly](#)
- [When I Run Viz Engine in Fullscreen My Graphic Quality Downgrades to SD](#)
- [Video Transfer from a Search Result to a GFX Channel Stays on 0%](#)
- [Video Transfer from a Search Result Gives Errors](#)
- [The Search Panel Looks Disabled and It Returns an Error about Viz One](#)

- [My Clips/Graphics do not Appear on the Output Engines when I Put Them On Air](#)
- [No Thumbnails for My Graphics Appear in Viz Multiplay](#)
- [The Show Opens but Doesn't Display Any Stories or Content](#)
- [I Have Set up Profiles but Get an Error about No Viz/Video Program](#)
- [Problems Running Preview Server](#)
- [Viz Multiplay Limitations](#)

 **Note:** To view log messages and version information, go to the [Status Bar](#).

### 5.3.1 The Viz Engine Output Keeps Going Black Randomly

If you are using your Viz Engine as a preview server you may see this behavior. Use another Viz Engine to serve out thumbnails.

### 5.3.2 When I Run Viz Engine in Fullscreen My Graphic Quality Downgrades to SD

This typically happens when using multiple screens. Verify that *Video wall/Multi display* is set correctly in your Viz Engine.

Go to **Viz Configuration > Video Output > Video wall/Multi display** and set this to *active*.

### 5.3.3 Video Transfer from a Search Result to a GFX Channel Stays on 0%

This can happen if Media Sequencer did not grab the information for asset storage(s).

To resolve this in Viz Multiplay, go to **Settings > General > Active Profile** and set it to *No Profile*, and then back to the one you were using. This reinitiates all transfers.

### 5.3.4 Video Transfer from a Search Result Gives Errors

*No destination available* errors can occur when there is an error with the publishing point in Viz One. Verify that your Viz One can FTP into your Viz Engine.

### 5.3.5 The Search Panel Looks Disabled and It Returns an Error about Viz One

Viz Multiplay can't access Viz One. This could be because there is no network connection to Viz One, or because there is incorrect host or login information.

In Viz Trio, verify the Viz One configuration by going to **Search Media** and performing a search. In Viz Multiplay, when you get the Viz One popup, use the same credentials as you used in Viz Trio.

### 5.3.6 My Clips/Graphics do not Appear on the Output Engines when I Put Them On Air

Always double check that the elements can be played out from Viz Trio. Also, run Media Sequencer in a console (not as a service) to get more information on what is wrong when taking elements on air. The messages in Media Sequencer console are often very useful.

### 5.3.7 No Thumbnails for My Graphics Appear in Viz Multiplay

Media Sequencer produces the thumbnail URLs for the elements, so it needs to have a Preview Server configured:

1. Go to **Settings > Servers** in Viz Multiplay, and verify that a preview server host is set.
2. When Viz Multiplay is loading, inspect the network traffic in the browser and look for the requests to Preview Server. Check the HTTP response, which contains an error message.

### 5.3.8 The Show Opens but Doesn't Display Any Stories or Content

If a Viz Trio show contains elements which are not within a group, then they will not be visible in Viz Multiplay. The show may appear empty in Viz Multiplay, even though Viz Trio show contains elements.

Create a group in the show and move elements into the group.

### 5.3.9 I Have Set up Profiles but Get an Error about No Viz/Video Program

The error may look like: *No Viz/video program for this entry. Please check the Viz/video program output configuration.*

This means that an element has been added to a channel that does not support it (for example, adding video to a graphics channel or vice versa). This can also occur if a profile is selected which does not have a program channel. Also try to deactivate the profile and reactivate it again.

### 5.3.10 Problems Running Preview Server

To troubleshoot Preview Server, go to the debug page for Media Sequencer on <http://mse-host:8580/debug> and browse to your show elements. Do you see thumbnails on this page? If not, click on the thumbnail and you will get an error message. You can also inspect the network traffic in the browser (in Chrome and Firefox by pressing **F12** and going to **Network**) when loading the show in Viz Multiplay. Inspect the HTTP response of the broken Preview Server requests, this should give you a hint as to where the problem lies.

### 5.3.11 Viz Multiplay Limitations

- Thumbnails for graphics with video texture will only display the graphic.
- Running Cleanup also cleans up the Presets scene. Therefore, after a cleanup, you must run a Preset before running other elements. To do this, click on a Preset.

- Avoid initializing while On Air, as this can result in a lag in the graphics output.
- Viz Multiplay does not support videos with overlay graphics as a timeline. To display graphics on top of videos, place GFX channels on top of each other and play elements manually in each channel.