



# Tracking Hub Administrator Guide

Version 1.7



# Viz Virtual Studio



**Copyright** ©2024 Vizrt. All rights reserved.

No part of this software, documentation or publication may be reproduced, transcribed, stored in a retrieval system, translated into any language, computer language, or transmitted in any form or by any means, electronically, mechanically, magnetically, optically, chemically, photocopied, manually, or otherwise, without prior written permission from Vizrt.

Vizrt specifically retains title to all Vizrt software. This software is supplied under a license agreement and may only be installed, used or copied in accordance to that agreement.

### **Disclaimer**

Vizrt provides this publication “as is” without warranty of any kind, either expressed or implied. This publication may contain technical inaccuracies or typographical errors. While every precaution has been taken in the preparation of this document to ensure that it contains accurate and up-to-date information, the publisher and author assume no responsibility for errors or omissions. Nor is any liability assumed for damages resulting from the use of the information contained in this document. Vizrt’s policy is one of continual development, so the content of this document is periodically subject to be modified without notice. These changes will be incorporated in new editions of the publication. Vizrt may make improvements and/or changes in the product(s) and/or the program(s) described in this publication at any time.

Vizrt may have patents or pending patent applications covering subject matters in this document. The furnishing of this document does not give you any license to these patents.

### **Antivirus**

Vizrt does not recommend or test antivirus systems in combination with Vizrt products, as the use of such systems can potentially lead to performance losses. The decision for the use of antivirus software and thus the risk of impairments of the system is solely at the customer's own risk.

There are general best-practice solutions, these include setting the antivirus software to not scan the systems during operating hours and that the Vizrt components, as well as drives on which clips and data are stored, are excluded from their scans (as previously stated, these measures cannot be guaranteed).

### **Technical Support**

For technical support and the latest news of upgrades, documentation, and related products, visit the Vizrt web site at [www.vizrt.com](http://www.vizrt.com).

### **Created on**

2024/01/16

# Contents

<b>1</b>	<b>New in Viz Virtual Studio 1.7.....</b>	<b>8</b>
1.1	Security Improvements .....	8
1.2	Improved Rendering in Studio Manager.....	8
1.3	NDI Workflow.....	8
1.4	Filter for unplausible tracking values .....	9
1.5	Improved timing monitoring .....	9
<b>2</b>	<b>Introduction.....</b>	<b>10</b>
2.1	Document Structure.....	10
2.2	Feedback and Suggestions.....	10
<b>3</b>	<b>Overview.....</b>	<b>11</b>
3.1	Introduction and Terminology.....	12
3.1.1	Key Technologies and Procedures .....	14
3.1.2	Software Components.....	15
3.1.3	Documentary .....	15
3.2	Tracking Hub.....	15
3.3	Tracking Hub Structural Design .....	16
3.3.1	Protocol.....	17
3.3.2	Parameters .....	17
3.3.3	Rig Objects .....	17
3.3.4	Basic Camera .....	30
3.3.5	Timing.....	34
3.3.6	Delay .....	34
3.3.7	Video Delay .....	35
3.3.8	Tracking Delay.....	36
3.4	Studio Manager.....	37
3.5	WIBU-based Licensing System .....	37
3.5.1	Important Pre-installation Information.....	38
3.5.2	Key Features and Workflow of the New Licensing System .....	38
3.5.3	Notable Limitations and Known Issues .....	38
3.5.4	Basic Setup .....	38
3.6	WIBU License System in Tracking Hub .....	40
3.6.1	One License Consumed.....	41
3.6.2	Two Licenses Consumed.....	42

3.6.3	Copy Rig Functionality .....	44
<b>4</b>	<b>Installation and Startup.....</b>	<b>46</b>
4.1	Important Checklist Before Installation.....	46
4.1.1	System Requirements .....	46
4.2	Viz Virtual Studio Folders.....	48
4.2.1	Installation Folders .....	48
4.3	Viz Virtual Studio Installation .....	48
4.3.1	To Install Tracking Hub and Studio Manager Using the Bundle Installer.....	49
4.3.2	To Repair or Remove Tracking Hub.....	51
4.3.3	Unattended Installation of Viz Virtual Studio Applications .....	51
4.4	Start Viz Virtual Studio.....	52
4.4.1	Manual Configuration of the Network Adapter IP Addresses.....	54
4.4.2	Start the Studio Manager.....	55
4.4.3	Activating Automatic Logon .....	56
4.4.4	License Configuration .....	57
<b>5</b>	<b>Lens File Editor .....</b>	<b>59</b>
5.1	Port Configuration .....	61
5.2	New Lens File Format.....	62
5.3	The Main Window and Contained Areas.....	62
5.3.1	Camera Selection .....	62
5.3.2	Lens Portlet .....	63
5.3.3	Group Portlet.....	65
5.3.4	Engine Control.....	66
5.3.5	Calibration Scene.....	66
5.3.6	Parameter Control and Views .....	67
5.3.7	3D View.....	68
5.3.8	Point Matrix.....	70
5.3.9	2D View.....	72
5.3.10	Shortcut System.....	73
5.4	Troubleshooting .....	74
<b>6</b>	<b>Studio Manager GUI .....</b>	<b>75</b>
6.1	Configuration Panel .....	75
6.2	Parameter Panel.....	76
6.3	Topology Panel.....	77
6.3.1	Tracking Systems.....	78
6.3.2	Rigs.....	80

6.3.3	Services .....	82
6.3.4	Topology Connection Lines .....	82
6.3.5	Topology Colors .....	83
6.3.6	Motion Capturing with Motion Analysis .....	83
6.4	Log Panel .....	84
6.5	Timing Analysis Window .....	86
6.6	Preview Panel .....	87
6.6.1	Interface Configuration .....	88
6.6.2	View Menu .....	89
6.6.3	Navigation .....	90
6.6.4	HUD.....	90
6.6.5	Cyclotron Editor.....	91
6.6.6	CyC Editor Angle and Width .....	99
6.6.7	Examples .....	100
6.6.8	Shape Area .....	101
6.6.9	Cyc .....	101
6.6.10	CoCyc .....	101
6.6.11	Objects Menu.....	101
6.6.12	Selectable Display Modes .....	102
6.6.13	Camera Handles.....	102
6.7	Post System .....	104
6.7.1	Create a Post Session .....	105
6.7.2	Load a Post Session .....	105
6.7.3	Configure a Post Session.....	106
6.7.4	Selecting the Recording and Replay Sources .....	107
6.7.5	Camera Channels.....	109
6.7.6	Post Offset and Delay.....	110
6.7.7	Post Data Storage .....	110
6.8	Data Flow Inspector .....	110
6.8.1	To Activate Monitoring.....	111
<b>7</b>	<b>Studio Manager Configuration .....</b>	<b>116</b>
7.1	Configure the Studio.....	116
7.2	Configure Topology .....	117
7.2.1	Configure a Tracking System .....	117
7.2.2	Configure a Rig.....	121
7.2.3	Configure a Service.....	123
7.2.4	Set a Delay.....	124

7.2.5	Set an Offset .....	124
7.2.6	Set Center Shifts .....	124
7.2.7	Analyze Time .....	125
7.2.8	Lens Range Calibration .....	128
7.2.9	Modify a Rig .....	130
7.3	Tracked Cameras and Viz Engine .....	133
7.4	Router Control .....	134
7.4.1	To Add a Router Control Preset.....	134
7.4.2	GPI IO Device Switching .....	140
7.5	Backup Configuration .....	141
7.6	Use of Templates .....	143
7.6.1	Using Existing Templates.....	143
7.6.2	Creating New Templates .....	144
7.7	Replay Tool.....	145
7.7.1	Prerequisites.....	146
7.7.2	Preparations .....	146
7.8	Post Data Inspector.....	158
7.8.1	Controlling the Data-plot .....	162
7.9	NDI Service .....	162
7.9.1	Features .....	162
7.9.2	Engine Configuration .....	163
7.9.3	Camera Configuration.....	163
7.9.4	Studio Manager Configuration .....	166
7.9.5	Viz Arc Camera Switching .....	168
7.10	Embedded NDI Tracking Data .....	169
7.10.1	Introduction.....	169
7.10.2	Setting up the Studio .....	170
7.10.3	Setting up the Tracker .....	170
7.10.4	Setup Rig Topology.....	173
7.10.5	Setup NDI Service.....	174
<b>8</b>	<b>Troubleshooting and Best Practices.....</b>	<b>176</b>
8.1	General.....	176
8.1.1	Syncing.....	176
8.2	Tracking .....	176
8.2.1	Tracking Networks.....	176
8.3	Lenses .....	176
8.4	Delay .....	177

8.5	NDI .....	177
8.5.1	Requirements and Limitations.....	177
8.6	Chroma Keying .....	178
<b>9</b>	<b>Appendices.....</b>	<b>179</b>
9.1	Words and Terminology .....	179
9.2	Supported Protocols .....	180
9.3	Supported NDI Cameras.....	181
9.4	Description of the XML protocol description file format .....	181
9.4.1	Start Element “vizth_xml_tracking”.....	181
9.4.2	Checksum Element .....	182
9.4.3	Extraction .....	182
9.4.4	Axis Element.....	182
9.5	Motion Analysis Integration .....	184
9.5.1	The CORTEX System.....	184
9.5.2	CCD Calibration .....	184
9.5.3	Sync and FPS (Frames per Second).....	184
9.5.4	Timing.....	185
9.5.5	Network Connection .....	185
9.5.6	Cortex Precision Limit.....	185
9.5.7	Motion Capturing.....	185
9.6	Ports Used by Tracking Hub and Studio Manager .....	186

---

## 1 New In Viz Virtual Studio 1.7



---

### 1.1 Security Improvements

A complete rework of the internal IO components enable the removal of outdated communication components. This improves the security and reliability of Tracking Hub.

---

### 1.2 Improved Rendering In Studio Manager

The timing and preview panel have been updated to the latest version of OpenTK. This results in an improved performance and higher framerate in the preview panel.

---

### 1.3 NDI Workflow

Tracking Hub is now able to handle embedded tracking data in the NDI stream. The tracking data in the NDI stream must follow a specific format which is documented in the NDI SDK documentation. Currently, two camera models are supported and certified. These models are the PTZ3 UHD and PTZ3 HD. Tracking Hub is able to extract the the tracking data without decoding and encoding the video. This improves performance of CPU and GPU.



Protocol

Name

Connection

Comport

Baudrate

Parity

Stop Bits

Data Bits

Host

Port

NDI Source

XMLFile

ReceiveTime Corr.

TwicePackets Corr.

Request Trackingdata

Smooth Timing

TO Multiplier

— NDI —

Receive Compressed

Use Framesync

---

## 1.4 Filter For Unplausible Tracking Values

In rare cases it can happen that an encoder delivers wrong or erratic values. A plausible filter allows to filter out such erratic sparks.

▼ Tick Count Settings	Error Percentage
yaw <input type="text" value="36,000.00"/>	<input type="text" value="0"/>
pitch <input type="text" value="36,000.00"/>	<input type="text" value="0"/>
roll <input type="text" value="36,000.00"/>	<input type="text" value="0"/>
fov <input type="text" value="1.00"/>	<input type="text" value="0"/>

Additionally, a new least square filter was introduced, which is able to smooth jittery encoder values.

---

## 1.5 Improved Timing Monitoring

New measurement methods are implemented to measure the travel time of tracking packages in the network.

---

## 2 Introduction

This Administrator Guide gives the information required to understand **Tracking Hub** and **Studio Manager**, two important software components in the Viz Virtual Studio solution. The term *virtual studio* in general normally refers to tools which seek to simulate a physical television and/or movie studio. The **Viz Virtual Studio** solution is a set of software and technologies to create virtual studios.

---

### 2.1 Document Structure

Title	Content
<a href="#">Introduction</a>	This section gives details on related documentation and how to contact Vizrt for Customer support. Details are also given for Customers to provide feedback on their Vizrt product.
<a href="#">Overview</a>	This section gives an overview of both the Tracking Hub and the Studio Manager.
<a href="#">Installation and Startup</a>	This section describes the system requirements, planning for installation and steps to install and start Viz Virtual Studio.
<a href="#">Studio Manager GUI</a>	This section describes the Studio Manager, skills needed to be familiar with the Studio Manager and how it operates.
<a href="#">Studio Manager Configuration</a>	This section describes how to configure Studio Manager and its components.
<a href="#">Appendices</a>	This section lists any additional information about the Viz Virtual Studio.

---

### 2.2 Feedback And Suggestions

We encourage suggestions and feedback about our products and documentation. To give feedback and/or suggestions, please contact your local Vizrt customer support team at [www.vizrt.com](http://www.vizrt.com).

### 3 Overview

The Viz Virtual Studio provides a perfect match between real and the virtual scene elements. The reality is a compromise between the technical possibilities and the perceptual ability of the audience.

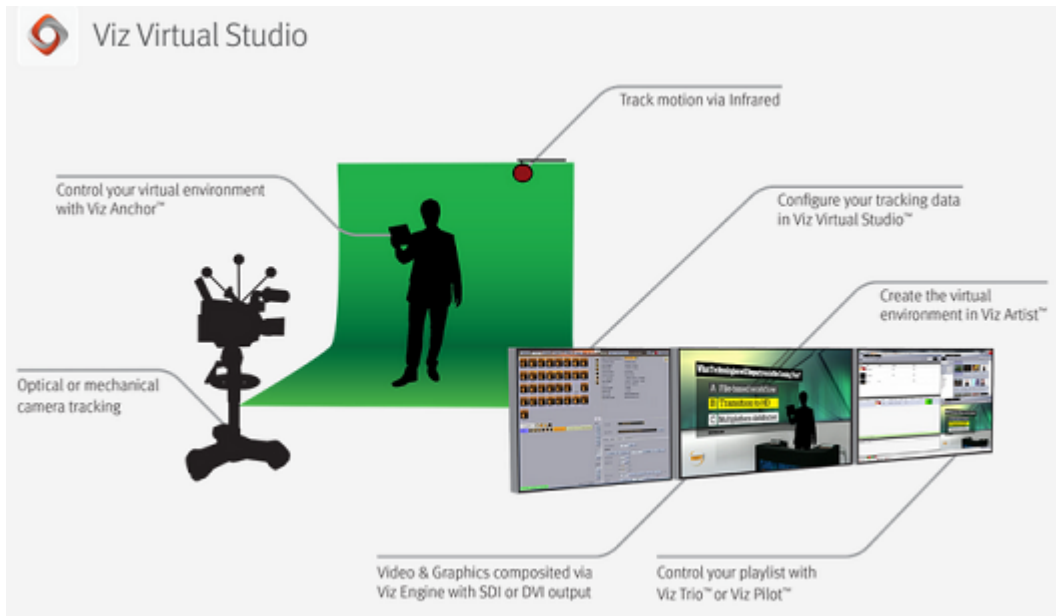

This manual gives a description of Tracking Hub and Studio Manager.

This release gives a limited feature set. Not all tracking devices, routers and GPI devices are implemented yet. The features of the Cyclotron (Cyc) Editor are limited. If more complex geometries are needed, or obstacles should be masked out, this needs to be done in the front layer of the Viz Engine.

**Note:** The Tracking Hub is intended for use with Viz Artist and Viz Engine versions 3.9.0 and later. The recommended versions are Viz Engine 4 or later.

If you are new to virtual studio technology or need a very short refresher, see the introduction in the [Introduction and Terminology](#) section.

This section contains information about the following topics:

- [Introduction and Terminology](#)
- [Tracking Hub](#)
- [Tracking Hub Structural Design](#)
- [Studio Manager](#)
- [WIBU-based Licensing System](#)
- [WIBU License System in Tracking Hub](#)

## 3.1 Introduction And Terminology

This chapter gives a brief introduction to Viz Virtual Studio (VS). It introduces a few key concepts intended for readers who are not familiar with Virtual Studio. The term *virtual studio* in general normally refers to tools which seek to simulate a physical television and/or movie studio. Viz Virtual Studio is a set of software and technologies to create virtual studios.

A virtual studio is a television studio that allows the real-time combination of people or other real objects and computer generated environments and objects in a seamless manner. A key point of a virtual studio is that the real camera can move in 3D space, while the image of the virtual camera is rendered in real-time from the same perspective. The virtual scene has to adapt at any time to the camera settings such as zoom, pan, angle, traveling and more. This is what differentiates a virtual studio from the traditional technique of Chroma keying.

A major difference between a virtual studio and the bluescreen special effects used in movies is that the computer graphics are rendered in real-time, removing the need for any post production work, allowing it to be used in live television broadcasts. The virtual studio technique is also different from Augmented Reality (AR) which is a live direct or indirect view of a physical, real-world environment with elements augmented (or supplemented) by computer-generated sensory input such as sound, video, graphics or GPS data.





### 3.1.1 Key Technologies and Procedures

The background (typically green) is masked away in real-time with a virtual software-created background. The physical objects in front (persons, desks, etc.) are merged with the virtual background creating the illusion of physical presence. The background is created and prepared in advance, typically using Viz Artist or by importing 3D-scenes into Viz Artist and saving them as scenes in Graphic Hub. Viz Engine, a real-time compositing engine, is responsible for combining the physical and virtual objects and to display the results (send the signal to a display, an IP stream or to send the signal downstream to a video mixer).

An important part of the virtual studio is the camera tracking that uses either optical or mechanical measurements to create a live stream of data describing the perspective of the camera. Exact camera and sensor tracking with as little delay as possible is the key difficulty to solve in a virtual studio.

### 3.1.2 Software Components

- **Tracking Hub:** A service process (runs as a console program without a GUI) responsible for receiving and forwarding measurements from cameras, trackers and other sensors. Tracking Hub must be kept running at all times.
- **Studio Manager:** A GUI for setting up, defining and controlling a Tracking Hub and the Virtual Studio environment.

Viz Virtual Studio uses the Viz Engine to render the output signal, whereas a client application such as Viz Trio, Viz Mosart or Viz Pilot is normally used to control the overall broadcast.

### 3.1.3 Documentary

If reading this on an Internet-connected device, you can view the Viz Virtual Studio documentation (see links below). See also [Words and Terminology](#) in the Appendix chapter for common words and their meaning.

The secrets of virtual set production is divided into five parts:

1. [What is virtual set and why should broadcasters use them?](#)
  2. [Virtual sets versus augmented reality](#)
  3. [Essential Vizrt tools](#)
  4. [Virtual set tools](#)
  5. [Design your story](#)
- 

## 3.2 Tracking Hub

Tracking Hub is a console program for the virtual studio, it collects data from tracking systems (cameras and objects) and stores this information. This tracking data is provided to Viz Engine at a configurable time or after a delay. To achieve exact tracking, many configurations are stored and provided to the user.

The Tracking Hub currently has these tracking drivers installed:

- FreeD (see [Description of the XML protocol description file format](#))
- RTHead
- XML Tracking: A special feature, a self-definable protocol for special solutions
- Motion Analysis
- mo-sys
- Trackman
- Vicon
- Libero
- CanonLens (Zoom and Focus driver for canon lenses)
- Spidercam
- Flair
- Thoma
- Stype A5
- Stype HF

- [Camreginfo](#)
- [Technodolly](#)
- [Skycam](#)
- [Gsgpoint](#)
- [Kuper](#)
- [FreeDa0](#)
- [spidercamfd](#)
- [Arraiy \(with VIZRT lens file\)](#)

### See Also

- [Tracking Hub Structural Design](#)
  - [Studio Manager](#)
- 

## 3.3 Tracking Hub Structural Design

This section covers the following topics:

- [Protocol](#)
- [Parameters](#)
  - [Parameter Pool](#)
- [Rig Objects](#)
  - [Pivot Rotation](#)
  - [Location Pivot Rotation](#)
  - [Arm Rig](#)
  - [Translation](#)
  - [Crane Arm](#)
  - [Crane Head](#)
  - [Lens File](#)
  - [Camera Rig](#)
  - [CameraFD Rig](#)
  - [Position and Rotation](#)
  - [Zoom and Focus](#)
  - [Center Shift](#)
  - [Mounting Offsets](#)
  - [Extended Lens Parameters Rig](#)
  - [Object Rig](#)
- [Basic Camera](#)
  - [Nodal Point](#)
  - [Mounting Offsets](#)
- [Timing](#)
- [Delay](#)
- [Video Delay](#)
- [Tracking Delay](#)



### 3.3.1 Protocol

The Protocol defines the data format sent from a tracking system to the Tracking Hub. It is independent from the transmission media and the geometry of the tracking system. The protocol generates tracked and named parameters, which are collected in the parameter pool. Protocols can be hard-coded in the Tracking Hub (like Motion Analysis), or as DLL files written with the plug-in API (available from version 2.0).

The XML Protocol Description was introduced in Tracking Hub 1.1. This protocol driver reads an XML file from either the hard drive or Graphic Hub. Out of this description, a parameter parser is generated which is able to read the data stream from the tracking system and translate it to named parameters, which are then sent to the Parameter Pool.

### 3.3.2 Parameters

A Parameter is a measured value of an encoder. It is extracted by the Protocol classes out of the Protocol data stream, the parameter is created by the Protocol. Its name is taken from the protocol description. The parameters in Tracking Hub are then converted from raw encoder values to human readable values, for example, the tick counts of a pan or tilt head are converted to degrees. The position tick counts are converted into centimeters.

Tracking delay and smoothing filters are applied to the parameter and can be adjusted per parameter.

#### Parameter Pool

All parameters are collected in the parameter pool. In the parameter pool, you find every encoder or optical tracked value.

### 3.3.3 Rig Objects

Rig objects (sometimes called Lattice objects) are used to represent geometry. The Tracking Hub separates *tracking* from *geometry*. All tracked parameters (axis) are collected in the *Parameter Pool*, as described in the Parameters section. Rig objects are built from hierarchical arranged sub elements where every sub element represents a mechanical or optical part of a tracked camera and its mechanical rigging.



Currently, the following rig elements are covered:

- Pivot Rotation
- Location Pivot Rotation
- Camera Rig
- Position and Rotation
- Zoom and Focus
- Center Shift
- Mounting Offsets
- Extended Lens Parameters Rig
- Object Rig
- Arm
- Translation
- CraneArm
- CraneHead
- Lensfile

## Pivot Rotation

Rotates the coordinate system of a rig around a free definable point in space. The camera Rig is bound to the pivot point in a parent-child relationship.

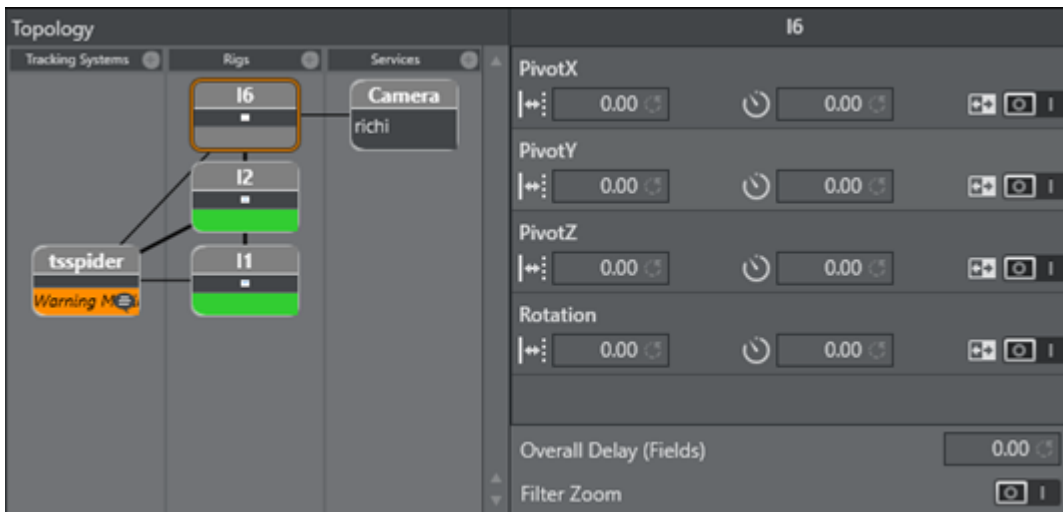

PivotX, PivotY and PivotZ define the location of where the rotation takes place. Rotation specifies the rotation in degrees around the Y Axis of the pivot point.

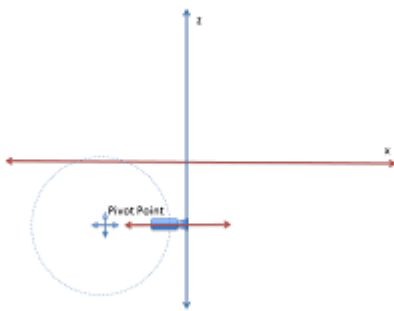

After the rotation, the coordinate system of the Rig is rotated around the Pivot Point. This is useful if, for example, a rail tracker needs to be adjusted in angle and offset to a studio coordinate system.

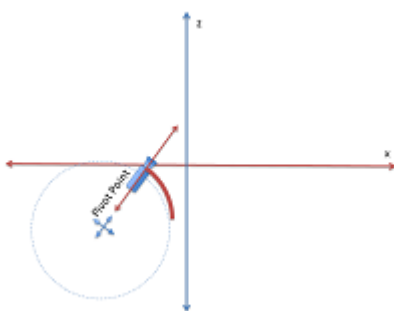

## Location Pivot Rotation

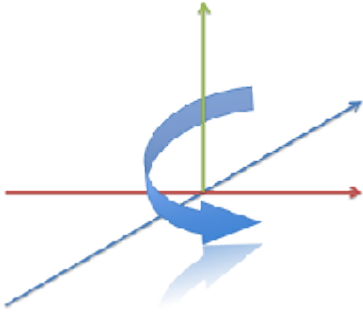

The location pivot rotation rig is similar to the Pivot Rotation. The difference is that this rig takes the pivot point coordinates from the child camera's position offset, which is attached to the camera position. This rig accepts only a rotation angle, as the position is taken from the child position offsets.

## Arm Rig

The Arm rig is mainly used for Spidercam setup, or anywhere a mounted arm follows a rotation axis. The rig does not include any head length or angle adjustments to the next child. All rotations that go into the Tilt, Pan and Roll axis are given to the next sibling. It is possible to set JointX, JointY and JointZ values to adjust mounting offsets between the position giving element and the arm.

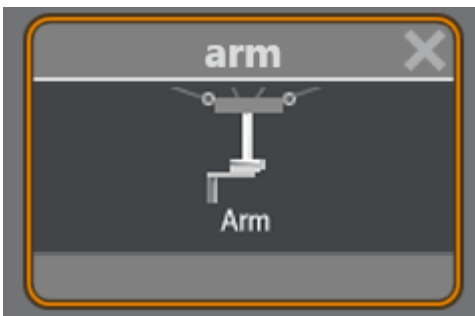

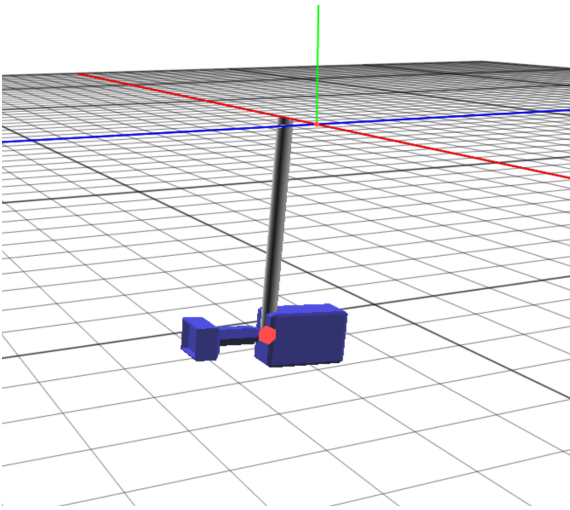

The arm length coordinates define the direction and length of the arm.



## Translation

The Translation rig is mostly used as parent rig to an Arm or CraneArm Rig. It lets you modify the position of all child rigs. **PosX**, **PosY** and **PosZ** can be used to track the position. It is a usual element in a Spidercam setup.

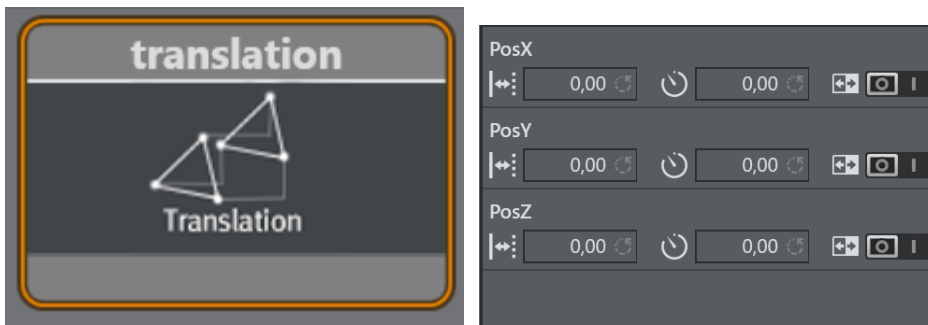

## Crane Arm

The Crane Arm rig is used to represent a crane arm. The difference from the normal Arm Rig is that the direction fields define a normalized direction of the arm, and the length is defined by the **ArmLength** field. In the arm rig, the **Length** parameters can be separated by axis.



You can set **JointX**, **JointY** and **JointZ** values to adjust mounting offsets between the position giving element and the arm.



**ArmdirectionX**, **ArmdirectionY** and **ArmdirectionZ** are normalized to `1` and define the initial direction of the Arm. Usually, **ArmdirectionZ** is set to `-1`.

## Crane Head

A Crane Head represents a perpendicular element, which can be attached to a crane arm, or to a simple arm. The **Headlength** defines the horizontal length in -Z direction after the perpendicular element. The **Headheight** defines the Height in -Y direction after the perpendicular element.



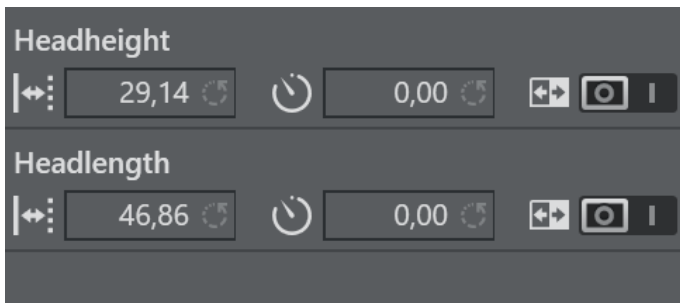
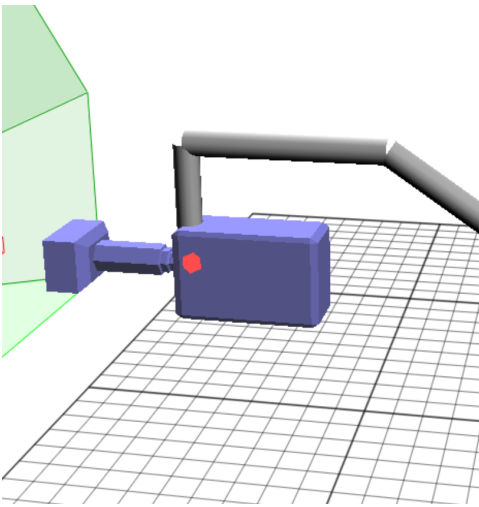

## Lens File



The Lens File rig must always be the first in a rig hierarchy. It is able to select one of the lens files, which must be located in the **Lensfile** folder in the Tracking Hub configuration folder in *%ProgramData%*. Once in the hierarchy, the lens file interprets the incoming raw zoom and raw focus values and sends FieldOfView, K1, K2, CenterShift and NodalPoint to the engine. The camera service object must be targeted to the lens file rig.



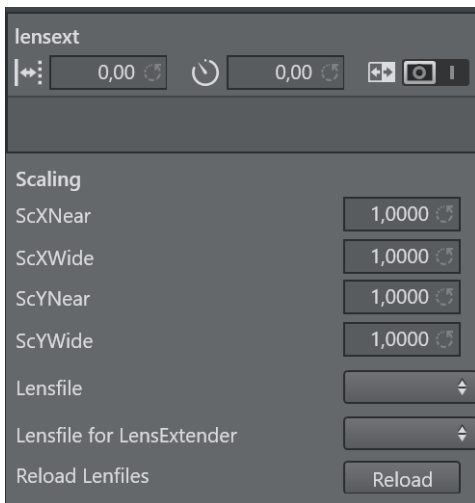

The only trackable parameter in the rig is the **lensex** parameter. In some protocols, such as **FreeD**, the lens extender is tracked. The value of **lensex** can be **0** or **1**. If it is **0**, the first lens file is used. If set to **1**, the second lens file is used. The scaling values define a scale factor for the field of view with respect to the actual zoom value. **ScYNear** and **ScXNear** are the scaling factor when the lens is completely zoomed in. **ScYWide** and **ScXWide** define the scaling factor when the lens is completely wide. Between Wide and Near, the values are interpolated. If you do any changes inside the lens file or add some new, you must press **Reload** to make them available in your configuration.

## Camera Rig

The Camera Rig represents the simplest camera known in the Tracking Hub. It holds the rotation and position parameters of a real camera in the studio. Zoom and Focus (in raw format coming from an encoder) and the Front, Height and Right lens shifts which are coming from the mount of the camera.



## CameraFD Rig

The CameraFD Rig is similar to the standard camera, but with special developments for the Spidercam fielddolly (FD) and a changed rotation order ( X Z Y ).

## Position and Rotation

Tilt, Pan and Roll defining the rotation of the camera around the X,Y and Z Axis. PosX, PosY and PosZ define the position of the camera in space. Each of these values might be tracked. In the case of a Pan/Tilt camera head which does not provide position information, the position can be adjusted in the offset values.

## Zoom and Focus

Zoom and Focus come from the Lens encoders (whether internal or external). In the system and in Viz Engine, these values are always normalized and go from 0 to 1. Therefore, it is most important that the Lens Ranges are calibrated correctly in the tracking system.

## Center Shift

Whenever you mount a lens to a camera body, the connection is never 100% the same every time; hence, there is always an offset between the camera body and the lens which shifts the angle of the light onto to charge-coupled device (CCD). In the Viz Virtual Studio software, this effect is called the Center Shift.

Note that every lens shows its own center shift and can for the most part be ignored as it is much smaller than the center shift caused when mounting the lens to the camera body. The most visible center shift is caused by the actual mounting of the lens and is more and more visible as the mount connection between the camera body and the lens becomes damaged/worn.

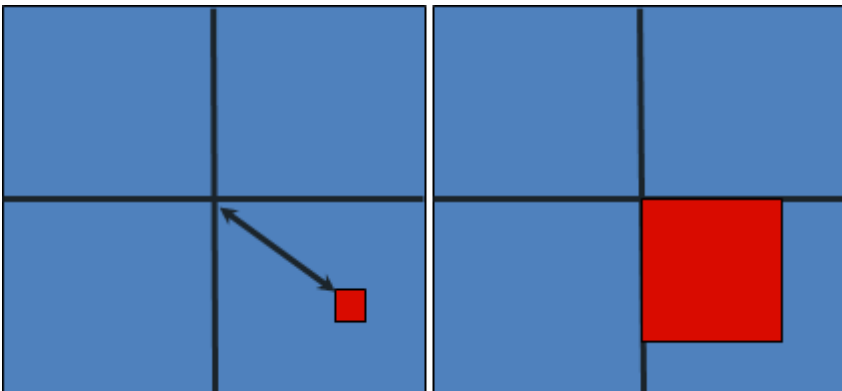

In order to calibrate the center shift, the Camera Rig handles the *CenterX* and *CenterY* offsets the following way: Completely zoomed out the full offset is applied and sent to Viz Engine. When zooming in, these values go in the zero direction until they reach absolute zero (completely zoomed in). It is **absolutely necessary** to calibrate this center-shift to get an acceptable tracking result. Whenever you see a movement of virtual objects when zooming in and out, you need to check if the center shift has changed.

The center shift can be corrected in the lens file only!

**Note:** Always check the center shift after mounting your lens to the camera body!

To calibrate the center shift, follow the algorithm below:

1. Reset the CenterX and CenterY values to zero.

2. Look for a corner or easy to identify point in the camera view.
3. Enable the Center Shift Cross in Viz Artist, see **Scene Settings > Virtual Studio**.
4. Zoom in completely to this point and adjust focus. This is also a good point in time to check the back focus of the camera.
5. Pan and tilt the camera until the corner or point aligns with the Center Shift Cross.
6. Zoom out completely and see that the point slides away from the center.
7. Adjust the CenterX and CenterY values until the corner or point aligns with the Center Shift Cross again.
8. Zoom out completely. If the Center Shift Cross is no longer in the corner or point, repeat from step 5.

**⚠ Note:** Repeat the steps until the Center Shift Cross is on the corner or point at all times. After two or three iterations, this is usually the case.

## Mounting Offsets

In order to get an acceptable result, we need to know the exact position of the camera's charge-coupled device (CCD) position. The CCD is (after the optical nodal point) the position of the Viz Engine remote camera. Not every tracking system gives that position. More likely, the position of the last rotation axis on the mechanical head is given, which in most cases is the tilt axis. If the sensor position is not clear, you need to contact the vendor of the tracking system.

After mounting a camera to a head, there are always offsets between the tracked point and the CCD of the camera. Many cameras have a mark on their body which marks the position of the CCD. If no mark is visible, you can assume that the CCD is 2 cm behind the mounting point of the lens.

In Tracking Hub, we know three mounting offsets. The *FrontLensShift*, *HeightLensShift* and the *RightLensShift*. The following drawings show the Front and Height Lens Shift and how these values change the behavior of the CCD.

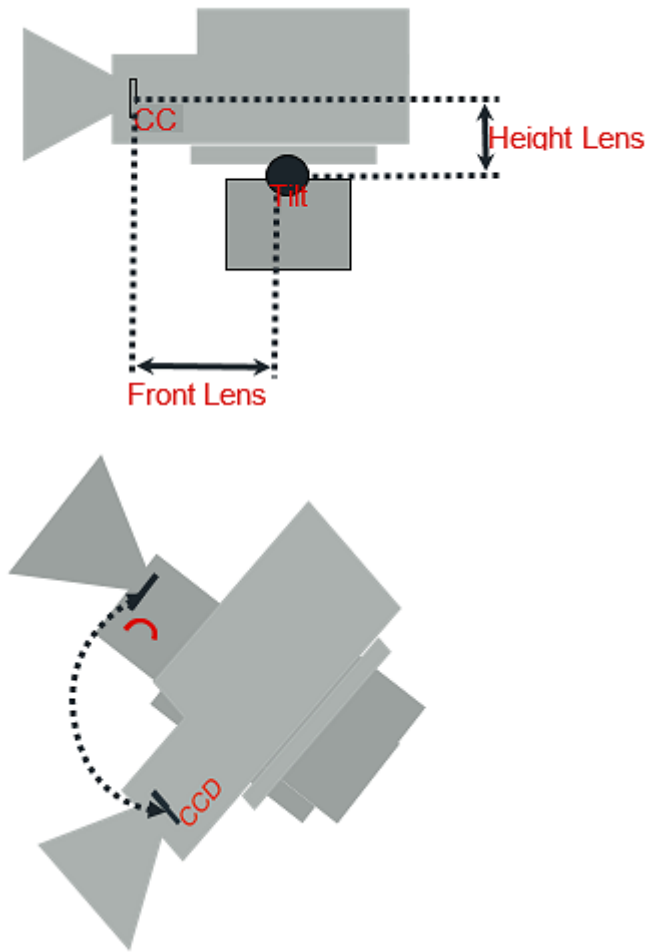

### Extended Lens Parameters Rig

The Extended Lens Parameters rig holds parameters which are rarely used and delivered by TrackMen and Libero only.

## Object Rig



The Object rig is used to position an object in Viz Engine with the use of shared memory and the object service. It can be used to mask out pedestals, which would be in view of other cameras or to track objects with the Motion Analysis tracking system. Pan/Tilt/Roll are the rotation angles of the object and *PosX*, *PosY* and *PosZ* are the position in centimeters (cm). Connected to an Object-Service the coordinates are sent to Viz Engine and can be applied to any objects in the Viz Artist scene tree by a script.

### 3.3.4 Basic Camera

The Basic Camera rig object has to be attached at the end of every rig structure. The most basic and commonly used parameters required for exact tracking are stored in this rig object. This section shows how the Tracking Hub needs to place the idealized OpenGL point camera to create an approximation of the physical studio camera.

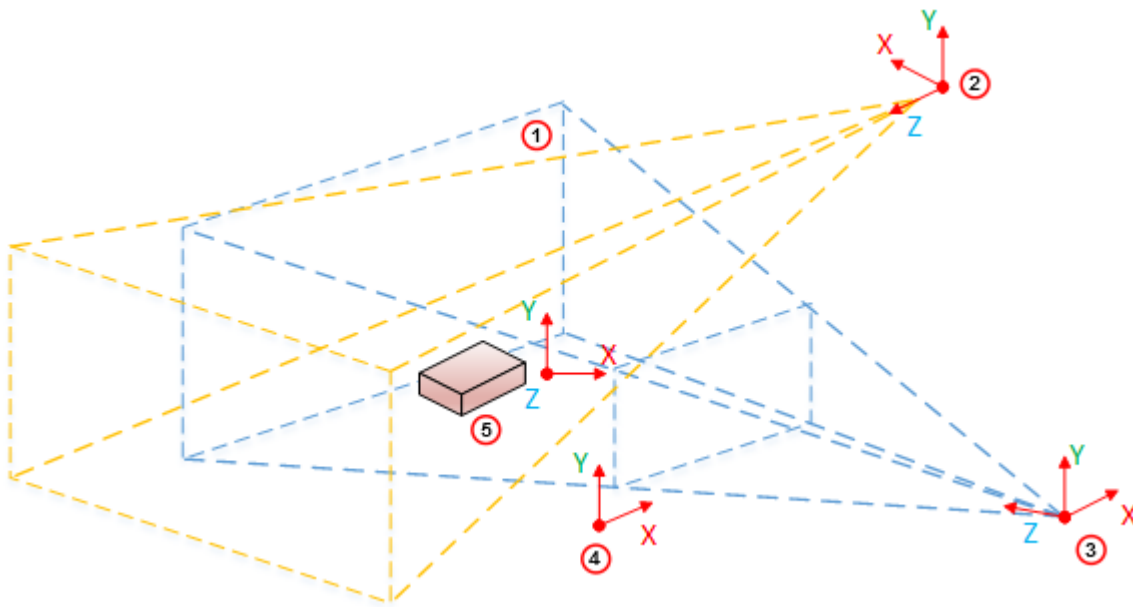

Item	Description
1	Clip space
2	Light Space
3	Camera Space
4	Image Space
5	Object Space

By default, the OpenGL camera is a point in space. All transformations (perspective and model view) are linear. It does not matter how much the zoom is increased in the perspective, or how near the camera is to an object in the model view transformation: A straight line in the model space is a straight line in the image projection. When the camera is rotated, it rotates around its position.

## Nodal Point

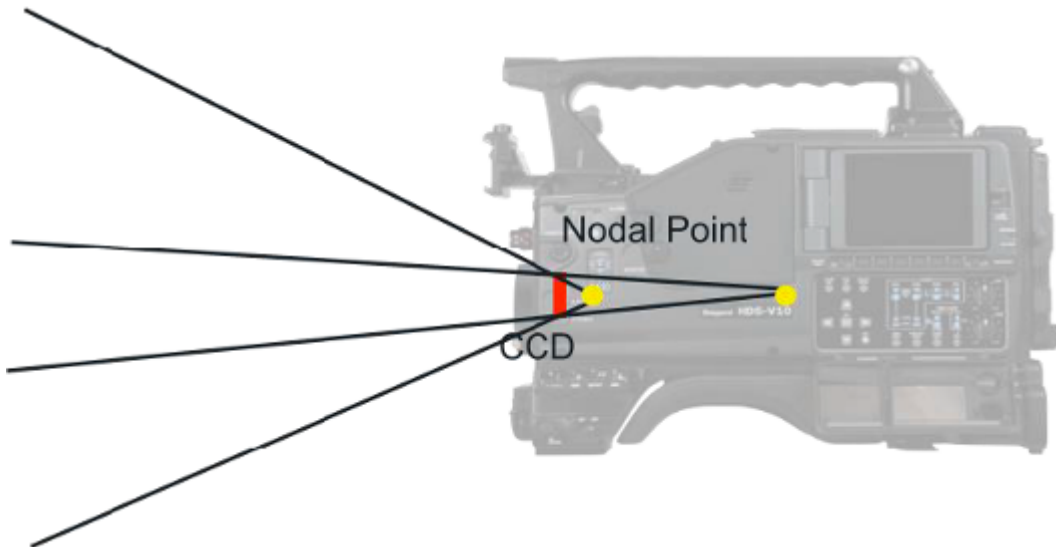

Let us assume the OpenGL camera is placed on the charge-coupled device (CCD) of the camera body. In the image, above, it completely depends on the field of view, where the light rays reflected from an object conjure to a point and create a sharp picture on the CCD. For sports, where the real camera is far away from the observed objects (we assume distances of more than ten meters), there is no influence from the adjusted focus. Therefore, in the image above we only observe the zoom effects on the nodal point of the objects watched.

Zooming in and out, causes the light rays, going through the lens, to conjure on a moving point behind the lens. In our Viz Virtual Studio software, we call this point the *Nodal Point*, and this point marks the position where we have to place our idealized OpenGL camera. The Nodal Point is defined during lens calibration, which is still happening in the Viz Engine. Therefore it is not an error, if you zoom in and out, and the position of the camera is moving towards and away from the Look-At direction of the camera. This is intended and must be done to provide an accurate result.

**⚠ Note:** Currently the Nodal Point comes from the lens file only.



### Mounting Offsets

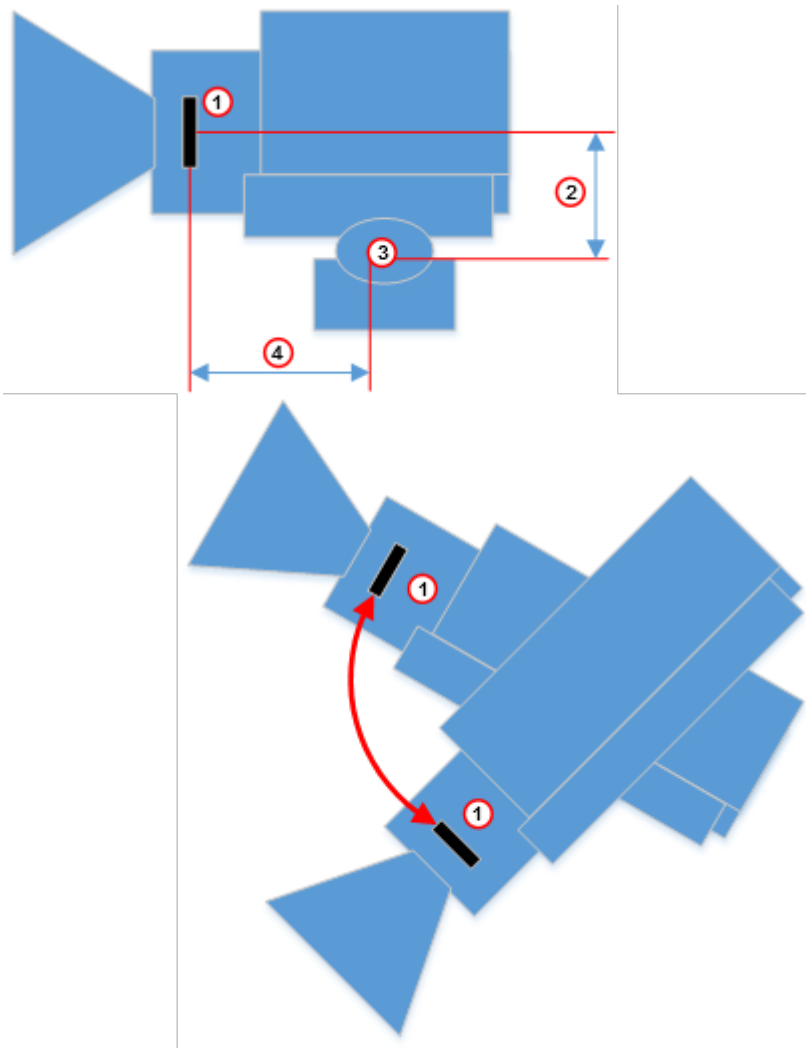

Item	Description
1	CCD
2	Height Lens Shift
3	Tilt Axis
4	Front Layer

### 3.3.5 Timing

As a prerequisite for a virtual studio, every part of the equipment must be synchronized. This includes the Viz Engines, the tracking systems and the Tracking Hub.

The Tracking Hub can be synchronized in two ways:

- Using a synchronized Viz Engine as sync source, or
- A Plura PCL-PCI card.

It is possible to switch the Tracking Hub to freerun mode. This is not intended for production purposes, rather it is meant for emergencies and experiments. **Never** under any circumstances use freerun mode for production. Even in freerun mode, the Tracking Hub generates a smooth result, but a change in delay becomes visible periodically. This occurs when the free running Tracking Hub swaps over the field border of a synchronized Viz Engine.

It is possible to run Tracking Hub in low latency mode. This is the case when the overall delay is set to a value below **1** in the rig. If you see missing data packages (indicated by warning displayed on the tracking system) you can increase the delay to values over **1**. At that point, Tracking Hub starts to interpolate missing tracking packages. If, from time to time, one data package is missing, a delay value between **1** and **2** is enough to smooth the data. When more than one package is missing (two successive missing packages), the delay must be increased accordingly. Even if this is possible with the Tracking Hub now, we want to achieve as low delay as possible. So if you see missing packages, you need to check the connection to the tracking system. Check if the system is synchronized in a correct way or find out what is causing this wrong behavior.

Use the *timing monitor* in Studio Manager to check the timing behavior of a tracking system.

### 3.3.6 Delay

The responsible technicians are confronted with delays between the incoming tracking data and the incoming video signals when a virtual studio is set up. We do not handle audio delays here, because audio is, in most cases, handled by the TV station's audio department.

We handle two different kinds of delays in the virtual studio:

- Video Delay
- Tracking Delay

### 3.3.7 Video Delay

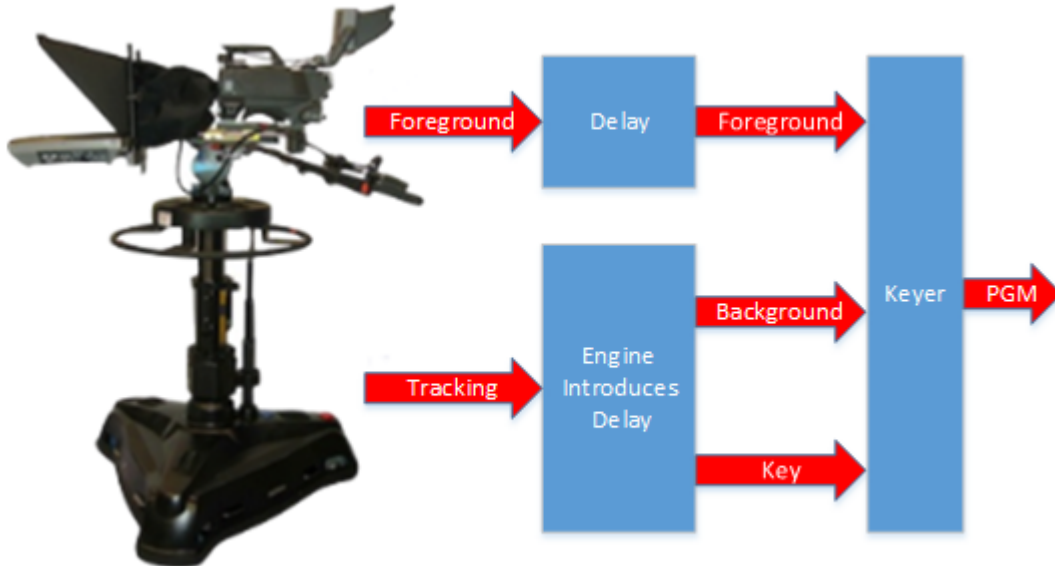

It is assumed that the camera and the tracking system are connected to the same sync signal. When the camera records an image, the tracking system acquires the camera's position, does some calculations and then sends this data to the Tracking Hub. One field later, Tracking Hub sends this tracking information to Viz Engine. Unfortunately, Viz Engine needs time to first render the image and additional time to output this image through the video card to its output. Normally, this process needs about two or three frames, depending on the video hardware used.

If we route the image from the camera directly to the keyer, the video is presented before the rendered image from Viz Engine. Therefore, delaying the video for a specific time is required to achieve a close match between the real image (i.e. the foreground in the virtual set) and the rendered image (i.e. the background in the virtual set). To apply this video delay, it is (or was) required to introduce a delay line which delays the video for a specific amount of frames.

**⚠ Note:** In interlaced modes, video can not be delayed for fields. Video delays can only be applied on a frame base.

Modern Keyers, such as the Ultimatte 11 or the Sapphire 3 have built in delay lines. An extra delay line must be installed when using older hardware.

### 3.3.8 Tracking Delay

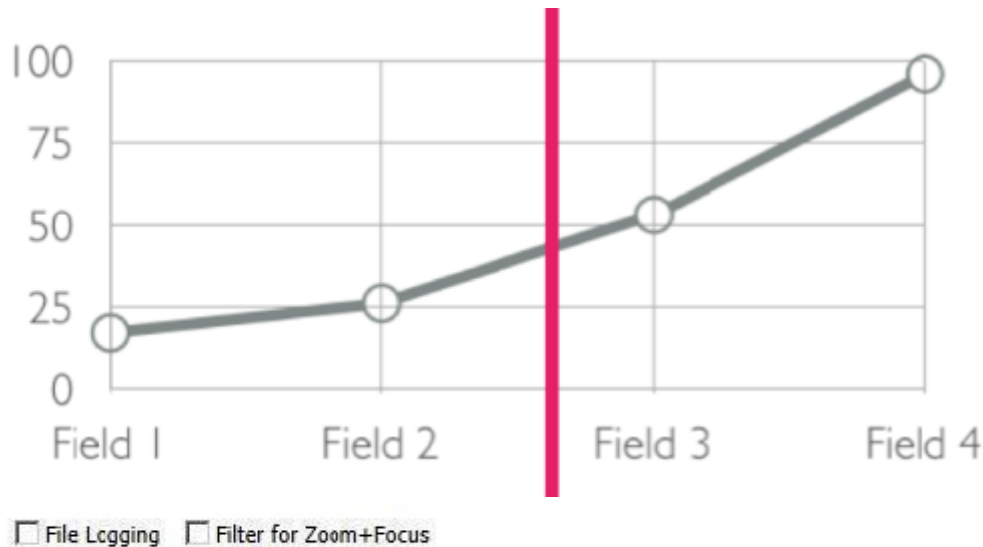

After reading the last section about Video Delay, you may have the impression that tracking systems and cameras sample the position or record the image exact at the flank of the sync signal (blackburst). This is not the case. Depending on the *exposure time*, *iris* and *gain* we do not know when the camera is recording the image. We only know for certain that the camera sends the image out at the next sync. But we don't know at what time during the field the image was recorded. Still worse, if you have a long exposure time (for example, two milliseconds) where is the point in time, the image was recorded?

The same problem occurs with tracking systems. Mechanical tracking systems are always near the sync flank, but they are never exactly at the flank. They always need a few milliseconds to read all the encoders and calculate the position from them. Using optical tracking systems compounds these problems. At what point in time are the cameras shooting the targets? We do not know. The only thing we know for certain is that there is always a fraction of a field delay between the tracking data and the video data, even when the video delay is set as accurately as possible.

From the last chapter we know, that video delay can only be set in whole values of frames. How do we set the fraction of a field?

**Note:** When the delay differs 0.1 field from the video, it is visible to the eye!

The only way to solve this problem is to **interpolate** using the tracking data received by Tracking Hub. There is an Overall delay setting in the Studio Manager Rig control that can be used to interpolate the tracking data in fractions of fields. In addition, every axis can have its own delay bias. This is useful, when mixing different tracking systems. When the overall delay is set to `0.5`, the Tracking Hub interpolates a half field back in time.

But what can you do if the delay must be set to `-0.5` to achieve a good result? This is not possible. We cannot attempt to extrapolate the data, because this probably results in ugly jumps. In this case, the only solution is to increase the video delay.

## 3.4 Studio Manager

The Studio Manager is a Graphical User Interface (GUI) for the Tracking Hub. When the Studio Manager opens, it presents a login window where the user can select the network interface and the Tracking Hub to control. With few exceptions, every part of the Tracking Hub can be controlled by Studio Manager.

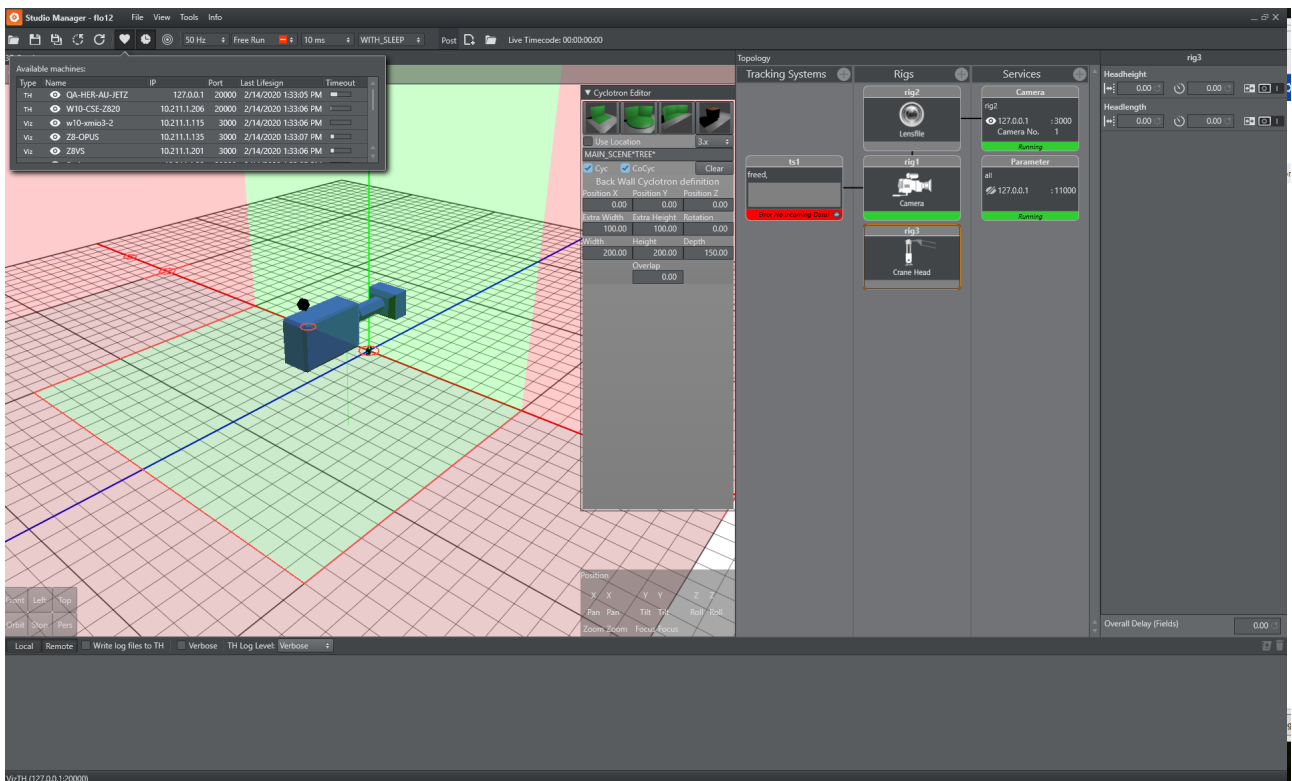

The Studio Manager application is described in the following chapters, in particular [Studio Manager GUI](#) and [Studio Manager Configuration](#).

### See Also

- [Tracking Hub](#)
- [Tracking Hub Structural Design](#)
- [Configure the Studio](#)
- [Configure Topology](#)

## 3.5 WIBU–Based Licensing System

This chapter describes management and usage of the new licensing system based on CodeMeter from [WIBU Systems](#) available in Viz Virtual Studio 1.1.1 and later. It replaces the previous VALID/Sentinel/Hardlock Dongle licensing system and allows Viz Virtual Studio to be used without a physical dongle on each machine by allocating licenses from a license server on the network.

The support for the old VALID/Sentinel/Hardlock Dongle was removed.

In this section, you find the following information:

- [Important Pre-installation Information](#)
- [Key Features and Workflow of the New Licensing System](#)
- [Notable Limitations and Known Issues](#)
- [Basic Setup](#)

### 3.5.1 Important Pre–installation Information

The WIBU licensing system requires the installation of the CodeMeter Runtime Software (included in the Bundle installer).

When the license should be retrieved from a dedicated license server, it must be configured in the VizrtLicensing Service (see the **Installation** section of the [Viz Licensing Administrator Guide](#)) or the CodeMeter WebAdmin.

Please refer to the [Viz Licensing Administrator Guide](#) for further detailed information.

- There is an auto discovery if no license server is configured in the server search list of CodeMeter.
- On network disconnect and reconnect, it may happen that a license is checked out twice. In this case, it must be released manually on the CodeMeter service on the license server or the license server can be restarted.

### 3.5.2 Key Features and Workflow of the New Licensing System

- Dongle-less operation on the clients with monitoring and logging capabilities.
- Grace periods for allocated licenses to avoid immediate expiration on short network interruptions.
- Configurable WIBU license container location (local, network).

### 3.5.3 Notable Limitations and Known Issues

- Only one license system can be used.
- Uninstall any CodeMeter Runtime prior. And afterwards install the Virtual Studio and the newer CodeMeter Runtime.

### 3.5.4 Basic Setup

These are the steps to set up Viz Virtual Studio licensing with WIBU:

1. Install Viz Virtual Studio with the bundle installer. Configure CodeMeter with the VizrtLicensing Service or the CodeMeter WebAdmin (can be opened from the CodeMeter Control Center).
2. Configure the license system in Viz StudioManager.

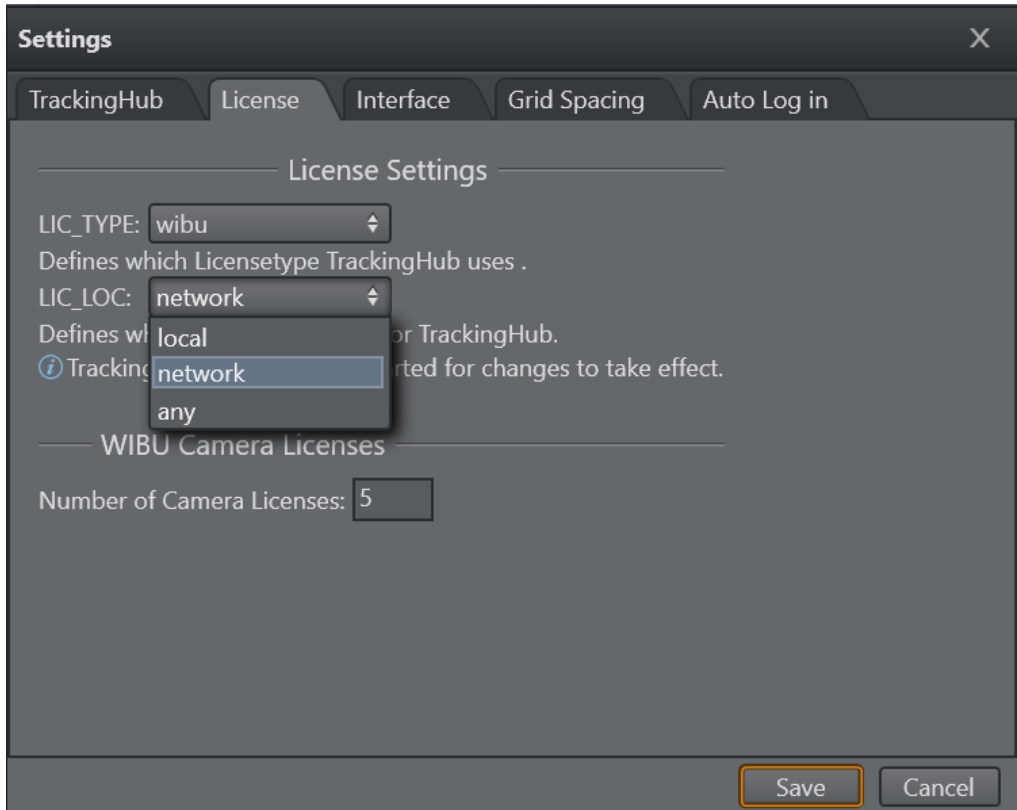
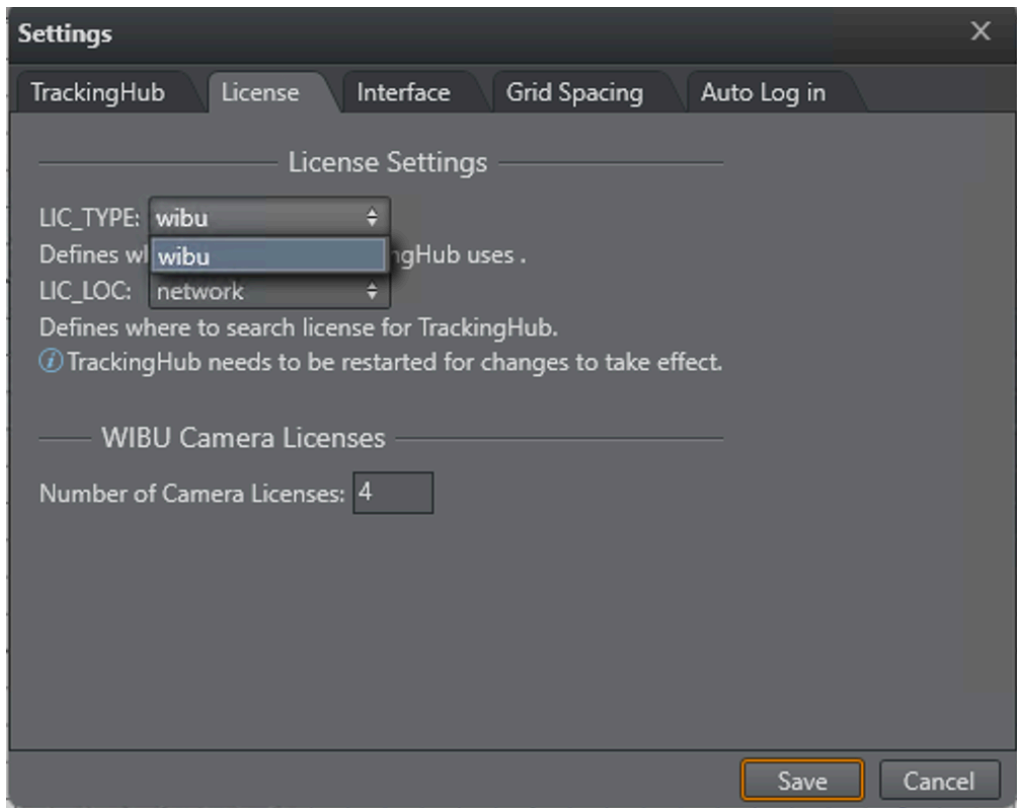

a. When using a WIBU license server:

- i. Open the CodeMeter WebAdmin and add the license server to the server search list.
    - ii. Configure Studio Manger LIC\_LOC to `network` or `network or any`.
  - b. When using a WIBU dongle:
    - i. Attach the WIBU dongle to any USB port of the machine.
    - ii. Configure to use legacy licensing. In the Studio Manager under **Tools Settings**, select **License**. Set LIC\_LOC to `local`.
3. Click **Save** and restart. License Information

Information about the license can be found in the Studio Manager under **Info License ....**

#### See Also

- **Client Configuration** page in the **License Server Setup and Administration** section of the [Viz Licensing Administrator Guide](#).

## 3.6 WIBU License System In Tracking Hub

Tracking Hub supports the WIBU license system. This has the advantage that licenses can be held on a central server and licenses can be acquired by any machine on the company network. It is still possible to use WIBU Dongles on a Tracking Hub machine. The WIBU Driver and the WIBU control application Codemeter are installed with the new version of Tracking Hub.

To run a Virtual Studio, two licenses are needed: The first one is called *Viz Virtual Studio*. Without this license, Tracking Hub starts up, but does not create any running services. This is the base license, used to run the Tracking Hub and the Studio Manager. The second license is for cameras. This license is called *VS\_CAMERA* or *Viz Virtual Studio Camera*.

The *VS\_CAMERA* license limits the amount of cameras which can be distributed by the Tracking Hub to the Engines or other Control Applications. It does NOT limit the camera services, or the virtual cameras, which are used in Viz. In Tracking Hub, a camera is represented as a connected combination of rig elements which calculate the CCD Position of a camera. It is possible to create one tracked camera out of two or more tracking systems, but one camera is always represented as one combination of rigs.

The *VS\_CAMERA* license also limits the amount of rigs which can be connected to active Camera Services. It is still possible to create any amount of rig structures in the Studio Manager. Limited is the amount of rigs, which can be sent from Tracking Hub to the Engines in Virtual Studio.



### 3.6.1 One License Consumed

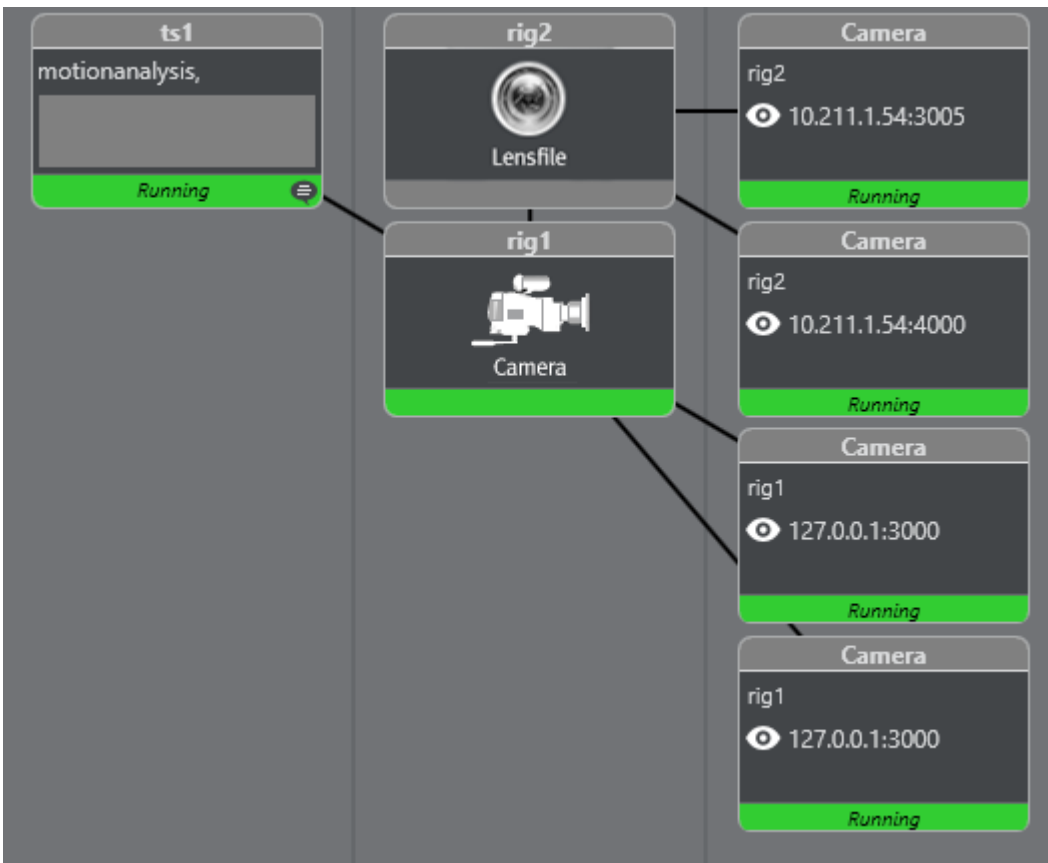
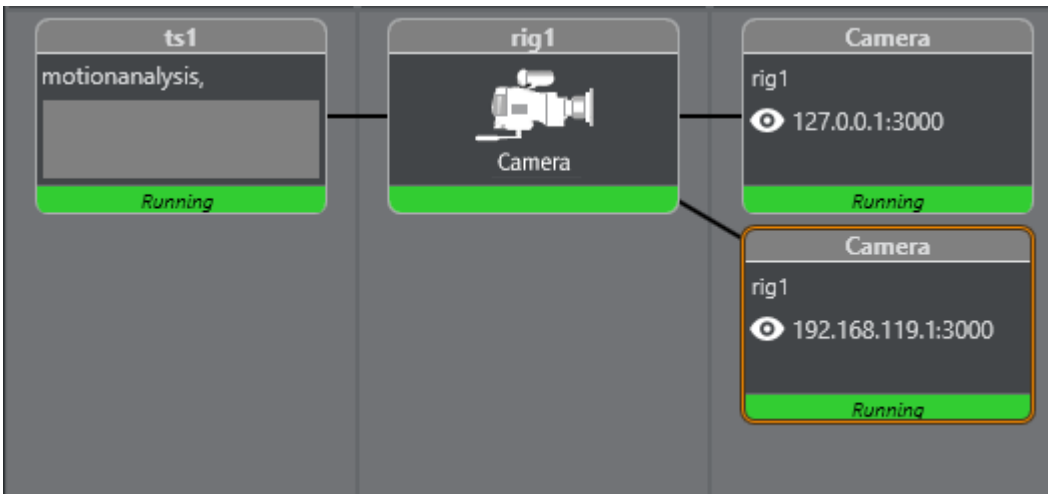

### 3.6.2 Two Licenses Consumed

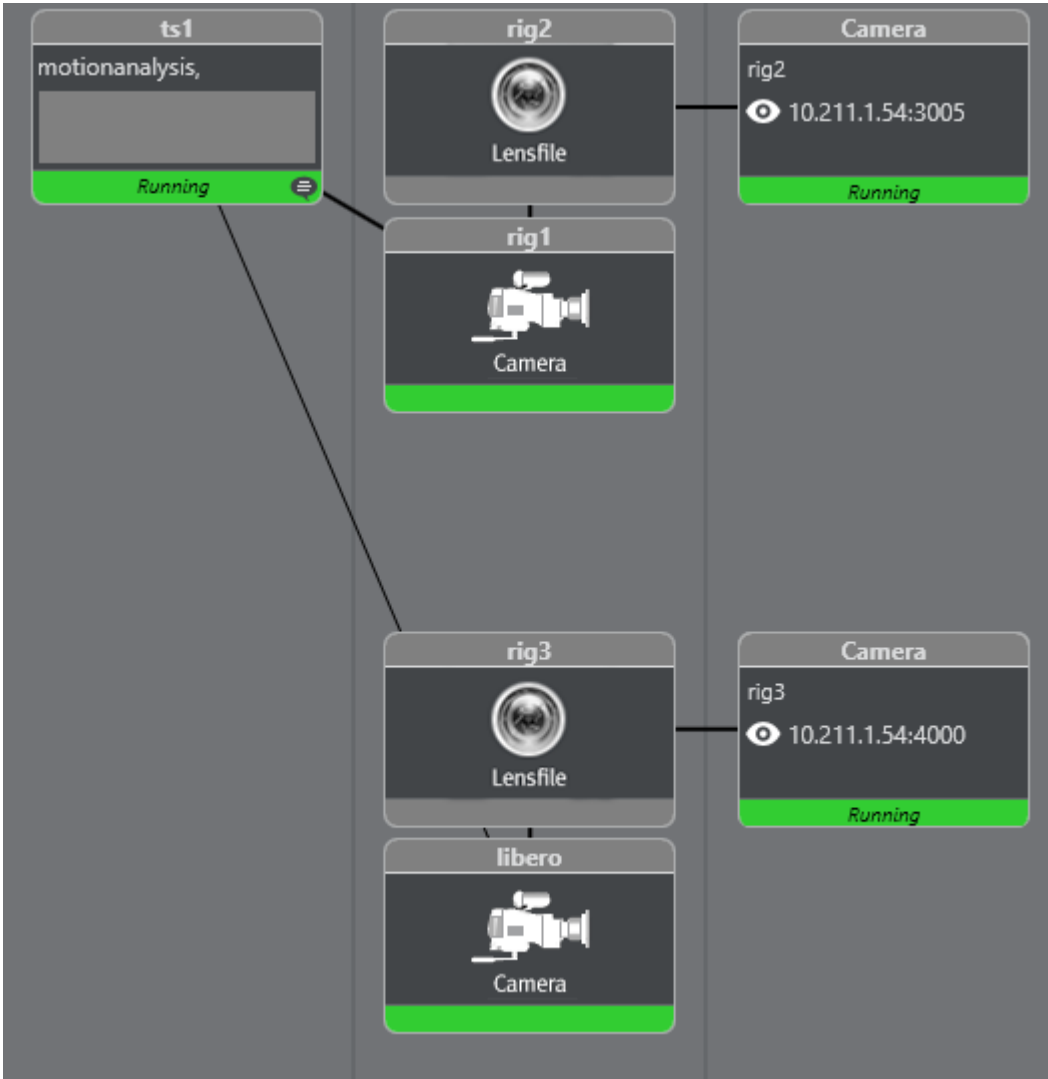

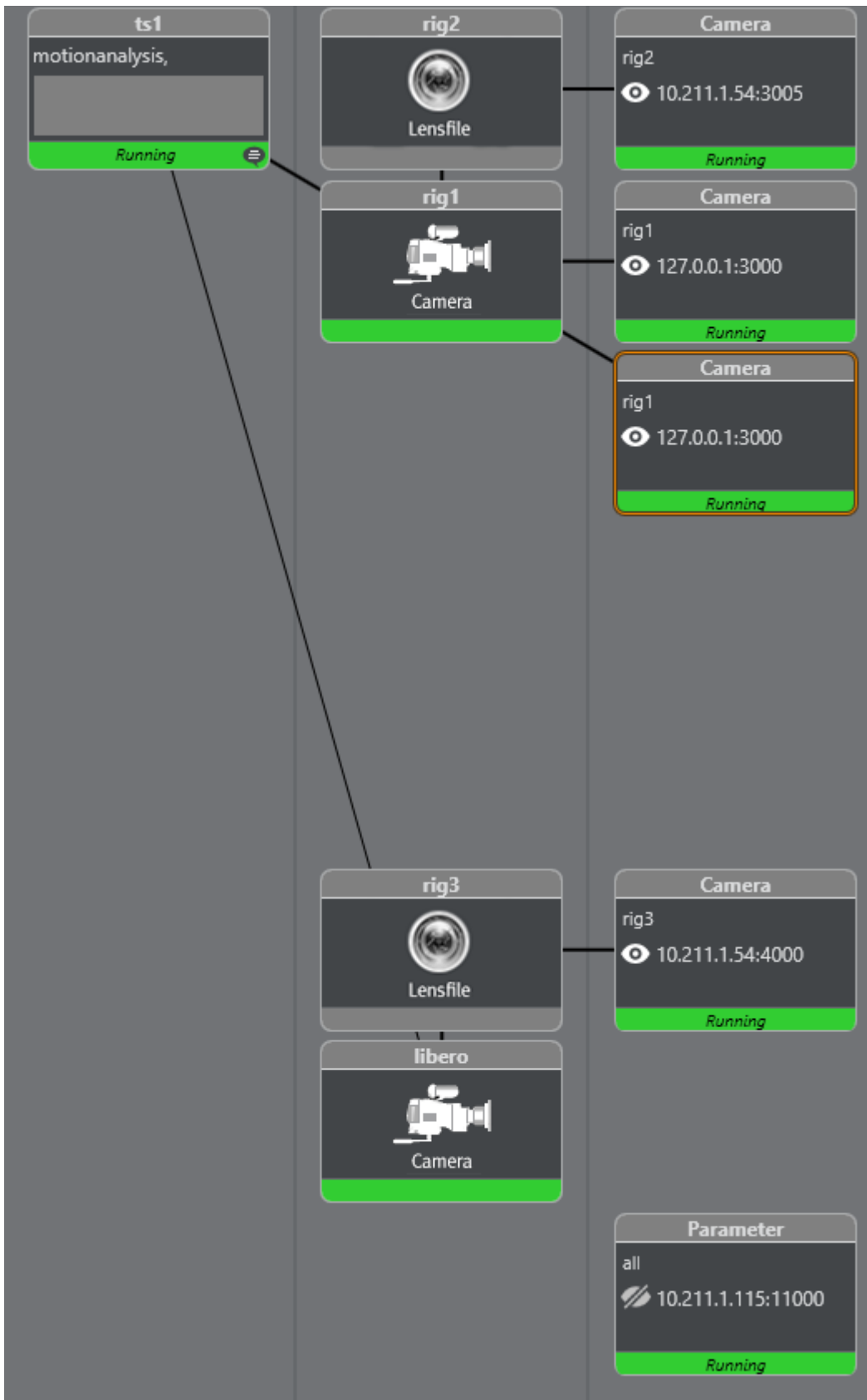

### 3.6.3 Copy Rig Functionality

In some special cases, two identical rigs with the same parameters are needed, but with different delays. One example is the Engine/Unreal Engine 4 (UE4) configuration, where the camera data sent to the Unreal Engine camera has more delay than the Engine camera. In former Viz versions, two licenses were consumed.

The ability to copy a rig setup was introduced in Tracking Hub version 1.3.0 to make the UE4 configuration easier and only consume one license.

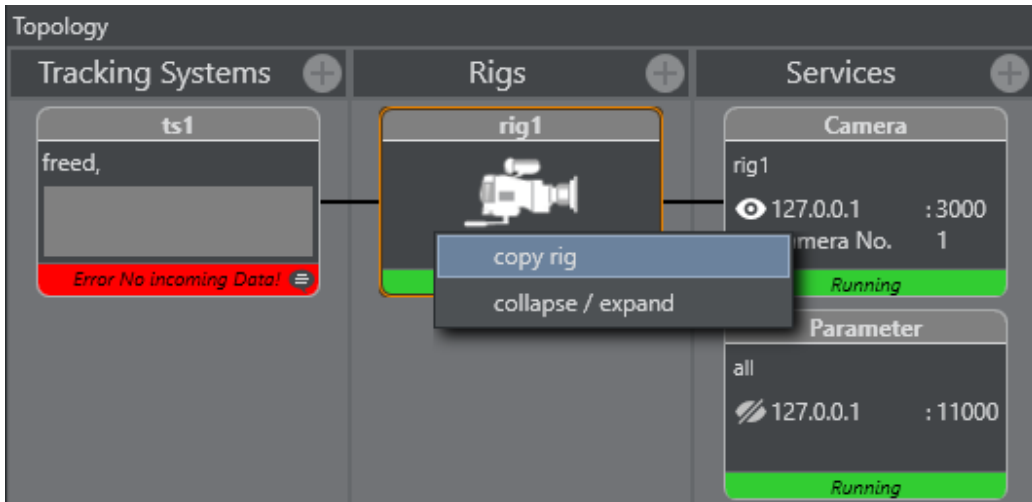

To create a rig copy, right click the rig you want to duplicate and click on the menu item **copy rig**. A duplicate of the rig is created. On this copy, all the parameter fields are empty. The only value which can be changed or modified is the overall delay.

Every change made to the original rig setup is automatically reflected in the copy.

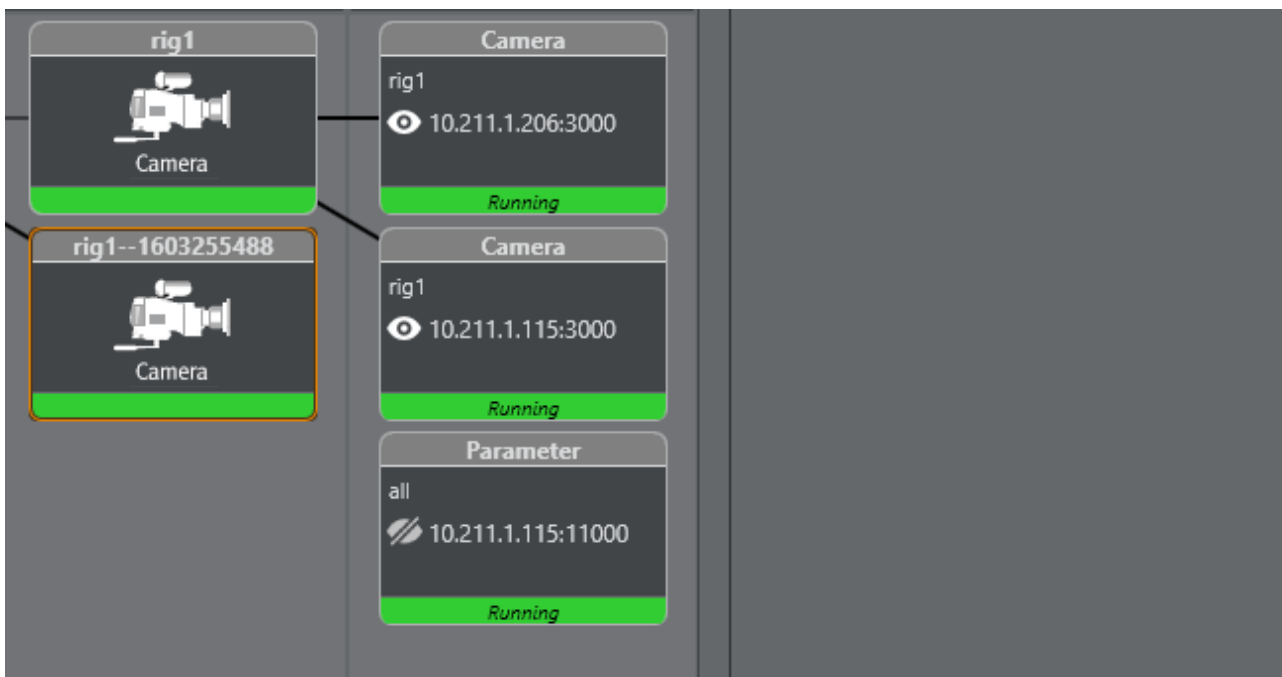

This copy is not counted in the license system.

---

## 4 Installation And Startup

This section details the installation requirements, the installation and system startup and shutdown. Before you install and configure the software, you should plan the installation.

This section contains the following:

- [Important Checklist Before Installation](#)
  - [Viz Virtual Studio Folders](#)
  - [Viz Virtual Studio Installation](#)
  - [Start Viz Virtual Studio](#)
- 

### 4.1 Important Checklist Before Installation

The items listed below must be checked before an installation can be done on site. Before an installation can be started make sure:

- Camera adjustments/shifts should always be set by camera personnel before any lens calibration is done. After any adjustments/shifts are set, the camera cannot be adjusted without being reconfigured.
- Cables: Who is in charge of the cabling before doing an installation?
- Tracking: What are the tracking system protocols?
- Transfer of tracking data: How is tracking data transferred and what kind of cables are used?
- Synchronization sources: What type of synchronization sources used?
  - Blackburst
  - Tri-level
  - In case Viz Engine is selected as the sync source, Tracking Hub must run on the same machine. Then the following sources can be selected in Viz Engine:
    - SDI input 1 or 2
    - NDI video source (input 1 or input 2)
    - PTP
- Location of the Viz Engines: Do you have physical access to the machines?
- Coordinate system: What are the coordinate systems for the tracking system(s) used?
- Make sure that there are no firewalls enabled.

#### 4.1.1 System Requirements

This section details the system requirements.

##### Synchronization

The Tracking Hub needs some sort of synchronization method on the machine it is installed. This can be:

- A running Viz Engine installation, or
- An installed Plura synchronization card.

**⚠ Note:** If sync sources is not found, Tracking Hub can still be used in free running mode. Free running is **not** intended and should not be used for production. It can, however, be used to experiment with tracking on a laptop. For use in production, either Viz Engine or Plura synchronization is necessary.

**⚠ Note:** 32-bit Operating Systems are no longer supported. For versions 1.2 and later, Tracking Hub and Studio Manager are available in 64-bit only.

## Minimum Hardware Configuration

- Minimum 8 GB Ram
- Dual-Core Intel CPU
- Windows 10 64-bit LTSC
- Minimum 10 GB of free disk space
- OpenGL Hardware-accelerated Graphics Card

## Minimum Hardware Configuration for use with Post and Replay

- Minimum 16 GB Ram
- Dual-Core Intel CPU
- Windows 10 64-bit LTSC
- Minimum 30 GB of free disk space
- OpenGL Hardware-accelerated Graphics Card

## Recommended Hardware and Software Configuration

- 32 GB Ram
- Quad-Core Intel CPU
- Windows 10 64-bit LTSC
- 30 GB of free disk space
- Nvidia P2000 Graphics Card

## Setup Required for NDI Workflow

- HP Z4 G4 - 6-Core CPU
- 32 GB Memory
- 2x Gbit RJ45
- 256 GB SSD for OS
- 512 GB SSD for Data
- NVIDIA RTX A4000 /16 GB GDDR6

## Supported Hardware and Software

- Windows 10 (64-bit) LTSC

- Viz Engine 3.9.0 (either 32-bit or 64-bit) or later, recommended Viz Engine 4.2 or higher
- Plura PCL-PCI and PCL-PCIe (L, LV, 3G) timecode reader cards (Driver 5.34)

**Important:** The PCL-PCI L card can only read timecodes and can NOT be used for synchronization.

- Studio Manager requires .NET framework 4.5.1 or higher.

### See Also

- [Viz Virtual Studio Installation](#)
- [Start Viz Virtual Studio](#)
- [Supported Protocols](#)
- [Supported NDI Cameras](#)
- [Troubleshooting and Best Practices](#)

## 4.2 Viz Virtual Studio Folders

### 4.2.1 Installation Folders

The default installations folders are

- *C:\Program Files\vizrt\VizTH*
- *C:\Program Files\vizrt\Studio Manager*

**Files which are created or can be modified** are located in *%ProgramData%\vizrt\VizTH*, and include:

- Config files.
- Crash dump files.

**Temporary files** are located at: *%TMP%\vizrt\VizEngine*, which usually resolves to *C:\Users\<user name>\AppData\Local\Temp\vizrt\VizEngine*. This folder is referenced as *<viz temp folder>* throughout this User Guide.

## 4.3 Viz Virtual Studio Installation

There are several setup applications available to install the components of Viz Virtual Studio, as indicated in the table below:

Setup Application	Content
<i>VizVirtualStudioBundle-x64-&lt;VERSION&gt;.exe</i>	Bundle with Tracking Hub and Studio Manager
<i>StudioManager-x64-&lt;VERSION&gt;.msi</i>	Studio Manager installer



Setup Application	Content
<i>TrackingHub-x64-&lt;VERSION&gt;.msi</i>	Tracking Hub installer

It is recommended to install *Studio Manager* and/or *Tracking Hub* using the *Tracking Hub Bundle* setup application, as this installs most of the prerequisite software as well.

Prerequisites for Tracking Hub are:

- Microsoft Visual Studio C++ 2012 Runtime
- Sentinel Runtime/WIBU Codemeter Runtimes

Prerequisites for Studio Manager are:

- Microsoft .Net 4.5.1 or higher.

Studio Manager asks to download Microsoft .Net 4.5.1 on startup if it is not already installed.

### 4.3.1 To Install Tracking Hub and Studio Manager Using the Bundle Installer

1. Log on to the computer as a Computer Administrator and start *VizVirtualStudioBundle-x64-<VERSION>.exe* to run the setup application.

- By default, the Tracking Hub and Studio Manager options are selected in the installer. If required, remove the options.



- Click **Install** and follow the on-screen instructions.

**Note:** The packages to install can be selected by check boxes, except the **Microsoft Visual C++ 2012 Redistributable** package, as it is a prerequisite. If a package is already installed (e.g. the Sentinel Runtime Dongle Driver), the check box is disabled.

After installation, the **Programs and Features** panel shows entries for each installed package

Name	Publisher	Installed On	Size	Version
CodeMeter Runtime Kit v7.10a	WIBU-SYSTEMS AG	27/08/2021	75,3 MB	7.10.4196.501
Microsoft Visual C++ 2012 Redistributable (x64) - 11.0.61030	Microsoft Corporation	27/08/2021	20,5 MB	11.0.61030.0
Microsoft Visual C++ 2015-2019 Redistributable (x64) - 14.27.29016	Microsoft Corporation	31/05/2021	22,6 MB	14.27.29016.0
Microsoft Visual C++ 2015-2019 Redistributable (x86) - 14.27.29016	Microsoft Corporation	31/05/2021	20,3 MB	14.27.29016.0
Sentinel Runtime	Thales	27/08/2021	21,0 MB	8.11.42480.60000
Vizrt StudioManager 1.5.0.20212	Vizrt	27/08/2021	111 MB	1.5.0.20212
Vizrt Viz Tracking Hub 1.5.0.20167	Vizrt	27/08/2021	49,8 MB	1.5.0.20167

### 4.3.2 To Repair or Remove Tracking Hub

Once the Bundle has been installed, you can run the Tracking Hub Bundle setup application again to enter **Repair** or **Uninstall** modes. Select **Repair** or **Uninstall** as required:

- Uninstalling the bundle removes each individual package. Exceptions are the **Microsoft Visual C++ 2012 Redistributable** and the **Sentinel Runtime** packages, as they are intended to remain on the PC. You can remove these packages separately, if desired.
- After Repairing, you must restart the computer. After restarting, you can proceed to [Start Viz Virtual Studio](#).

### 4.3.3 Unattended Installation of Viz Virtual Studio Applications

#### Installation Parameters

Parameter name	Default Value	Available values
<b>Tracking Hub MSI</b>		
INSTALLFOLDER	%\Program Files%\Vizrt\VizTH\	
<b>Studio Manager MSI</b>		
INSTALLFOLDER	%\Program Files%\Vizrt\StudioManager\	
<b>Virtual Studio Bundle</b>		
INSTALLFOLDER	%\Program Files%\Vizrt\VizTH\ %\Program Files%\Vizrt\StudioManager\	

#### Example

Description	Command
Install Tracking Hub in unattended mode with only progress bar using the <i>msi installer</i> and installation path is C:\TH	<pre>msiexec /i TrackingHub.msi /passive INSTALLFOLDER="C:\TH"</pre>

Description	Command
Install Studio Manager silently with no UI using the <i>msi installer</i> and installation path is <i>C:\SM</i>	<pre>msiexec /i StudioManager.msi /qn INSTALLFOLDER="C:\SM"</pre>
Install Tracking Hub in <i>C:\TH</i> and Studio Manager in <i>C:\SM</i> and all necessary MS Visual C++ redistributables, CodeMeter runtime kit and sentinel runtime using <i>Virtual Studio Bundle</i>	<pre>VizVirtualStudioBundle-x64.exe --silent --trackinghub=INSTALLFOLDER='C:\TH' --studiomanager=INSTALLFOLDER='C:\SM'</pre>

## 4.4 Start Viz Virtual Studio

- [Manual Configuration of the Network Adapter IP Addresses](#)
- [Start the Studio Manager](#)
- [Activating Automatic Logon](#)
- [License Configuration](#)
  - [Closing Viz Tracking Hub](#)

First start Tracking Hub, then start Studio Manager. Tracking Hub starts as a console program:

```

Tracking Hub 1.7.0.20402
[12:57:48.628] [I]: create_deferred ok. result:
[12:57:48.630] [I]: [ProgramData: C:\ProgramData\vizrt\VizTH\][TmpDir: ][_apprev: 1.7.0.20402] initializing app with programdata and tmpdir.
[12:57:48.630] [I]: [Build_Comment: x64- by jenkins:2024-01-01T21:30:59:1BEAFA67663][Head: 1.7.0-alpha.402+Branch.devel op.Sha.ae365f59f3c314b1a929153da9d5d785fd2b7e3d][Private_Build: 1][Product_Pre-Release: 1][WC_Date: 2024-01-01T21:30:59] [_apprev: 1.7.0.20402] app build.
[12:57:48.630] [I]: [log_level: 0][log_level_name: T][logger_name: default] log config.
[12:57:48.630] [I]: [parse_result.category: system][parse_result.value: 0/0x000000][parse_result.message: The operation completed successfully.] parse log info: config file: C:/ProgramData/vizrt/VizTH//TrackingHub_log_config.json. resulted in: trying: C:/ProgramData/vizrt/VizTH//TrackingHub_log_config.json
[12:57:48.630] [I]: [apply_result.category: system][apply_result.value: 0/0x000000][apply_result.message: The operation completed successfully.] apply log info info resulted in:
[12:57:48.630] [I]: current active log configuration: instance: 0
formatters: [ th_console_formatter, th_file_formatter, ]
logger: default, dist_sink(): [ console_sink(th_console_formatter), file_sink(th_file_formatter), ]
[12:57:48.640] [E]: starting up.
[12:57:48.640] [E]: File = 1.7.0.20402 Product = 1.7.0.20402 W_HEADREV = 20402
[12:57:48.640] [E]: Starting CommandHandler_Console.
[12:57:48.640] [I]: Start Io3_Svc_Worker
[12:57:48.641] [E]: Io3_Handler starting up
[12:57:48.641] [W]: Io3_Handler parse_startup_commands( startup_conf )
[12:57:48.641] [I]: insert to port list: 20000
[12:57:48.641] [I]: port list: 20000
[12:57:48.641] [I]: Start TCPServer Thread ...
[12:57:48.641] [W]: Io3_Handler ReadBaseConfig
[12:57:48.642] [W]: TCPServer starting up
[12:57:48.642] [I]: XML Load result: No error
[12:57:48.905] [C]: Allocate additional 5 Cams

```

Tracking Hub does not load correctly if the configuration file *VizTH.conf*, located at *C:\ProgramData\vizrt\VizTH*, is missing.

Usually, the tracking network is separated from the Engine network. This makes sense when Tracking Systems need their own IP range, and when the amount of tracking data should not interfere with regular network traffic. Tracking Hub can be set to a Viz adapter, which communicates with the Engines, and a tracking adapter which communicates with the tracking system. On the first startup of the Tracking Hub, the local loop back adapter is selected. Changing the network settings is mandatory after the first installation on a new machine.

To change the adapters used by Tracking Hub, select **Settings** from the **Tools** menu in Studio Manager.

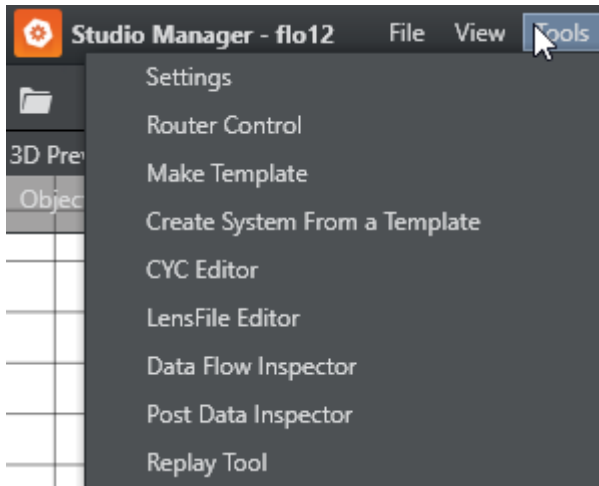

**Settings**

TrackingHub License Interface Grid Spacing Auto Log in

**Network Settings**

VIZ IP: loopback pseudo-i  
 Defines which network adapter TrackingHub uses as viz interface.

TRACKING IP: loopback pseudo-i  
 Defines which network adapter TrackingHub uses as tracking interface.

PARAM. SERVICE PORT: 11000  
 Defines which port is used for receiving Parameter Data.

WEBSOCKET PORT: 9090  
 Defines which port is used for websocket Communication (Lensfile Editor).

LensFileeditor: HTTP://127.0.0.1:9090

Copy to Clipboard Open Browser

TrackingHub needs to be restarted for changes to take effect.

**Backup Role**

Role: Master

**Backup TH**

Backup IP: 10.211.1.26 Synchronize Status

**CenterShift**

Interpolation

Save Cancel

**IMPORTANT!** If changing the network adapter, Tracking Hub needs to be restarted for any changes to take effect.

#### 4.4.1 Manual Configuration of the Network Adapter IP Addresses

1. Start the Tracking Hub and then immediately close it.
2. Go to the configuration folder (the default path is *C:\ProgramData\vizrt\VizTH\Cfg*) and edit the file *BaseConfig.xml*. *BaseConfig.xml* is a XML-formatted text-file. When editing the

file, be sure to use a text editor such as Notepad(++) or similar, and save it as a text-formatted file.

3. In the fields `VizAdapter="xxx" TrackingAdapter="xxx"`, specify the adapter names or IP addresses.

✓ **Tip:** You can view the IP-addresses in use by the server by opening a command prompt and entering the command `ipconfig`.

4. **VizAdapter** and **TrackingAdapter** can have the same setting.

This needs to be done only once. After the command is executed, *BaseConfig.xml* is updated.

⚠ **IMPORTANT!** You can minimize the Tracking Hub console program, but it should be kept running at all time.

## 4.4.2 Start the Studio Manager

1. Start the Studio Manager:
2. In the Tracking Hub login window enter the required details:
  - **Network Adapter:** Select a network adapter from the Network Adapter List.
  - **Tracking Hub:** Select a Host from the drop-down list. Under certain conditions, such as the server being located on a different network sub-net, the host does not appear in the list. The host name or IP address can then be entered manually.

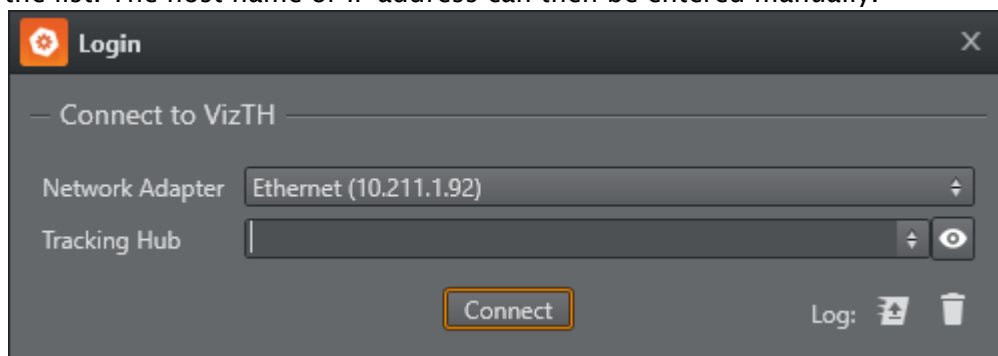

- The dialog remembers the last Adapter which was selected. If auto logon is enabled, the Studio Manager connects to the last selected Tracking Hub.

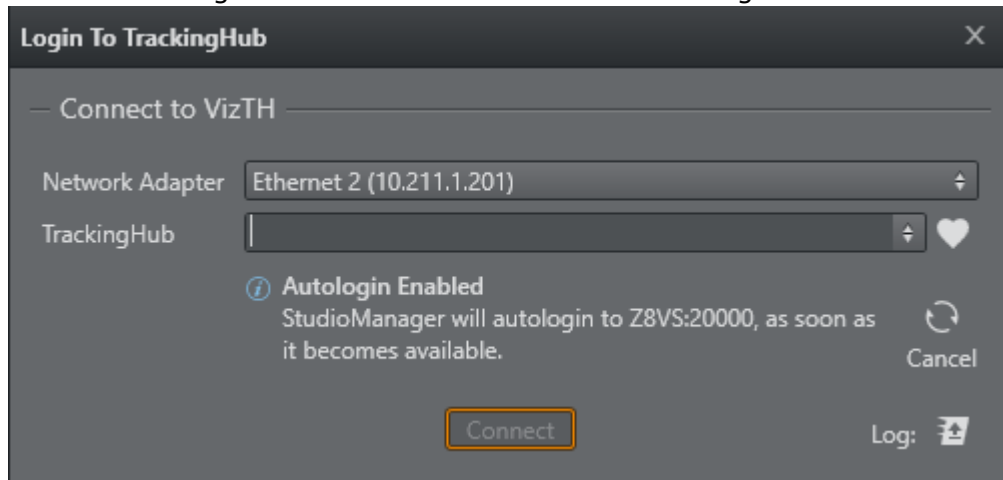

3. Click **Connect**.

#### 4.4.3 Activating Automatic Logon

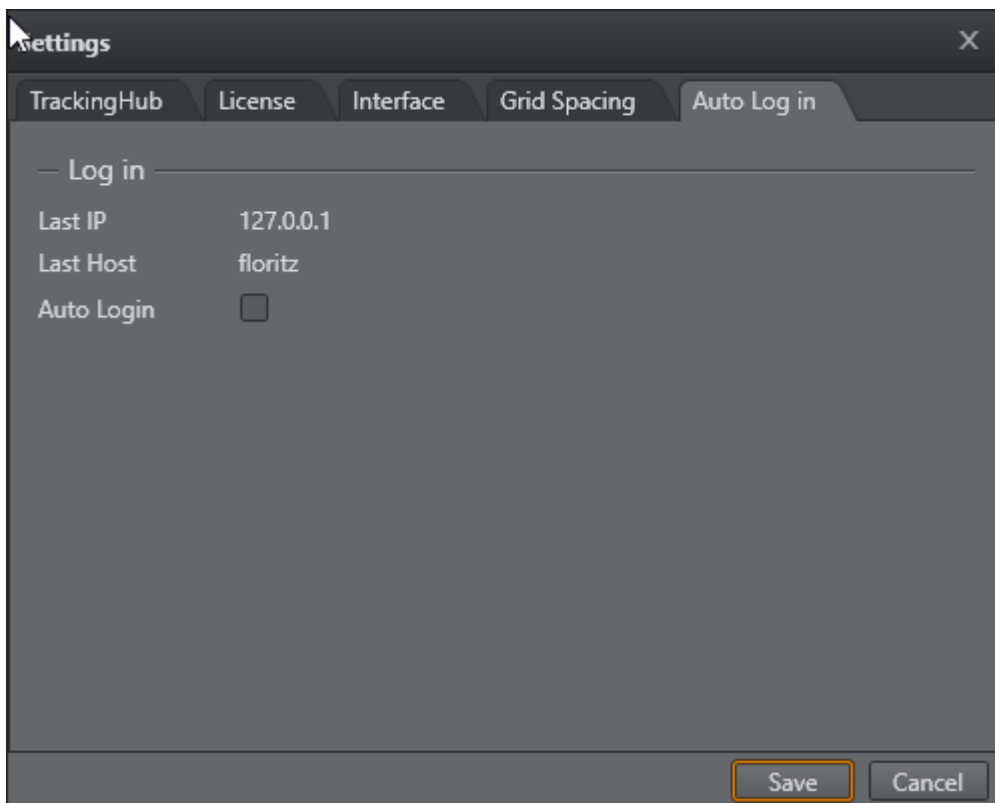

Automatic logon can be activated and deactivated in the **Auto Log in** Tab of the Settings Dialog.



#### 4.4.4 License Configuration

Tracking Hub requires a valid license to work with. This license can be allocated via the WIBU system.

For WIBU licenses, you have different options: You can either use a dongle based license or a network license.

- If a network server is going to be used, make sure the server is listed in the server search list of the Codemeter Web Interface. This can be accessed by browsing to [http://localhost:22352/configuration/server\\_search\\_list.html](http://localhost:22352/configuration/server_search_list.html). Add the server hosting the license into the server search list.
- A dongle can be either a physical dongle one or a software based one. Both of them need to show up in the Codemeter UI.

After starting Studio Manager, you'll need to go to **Tools > Settings and License**.

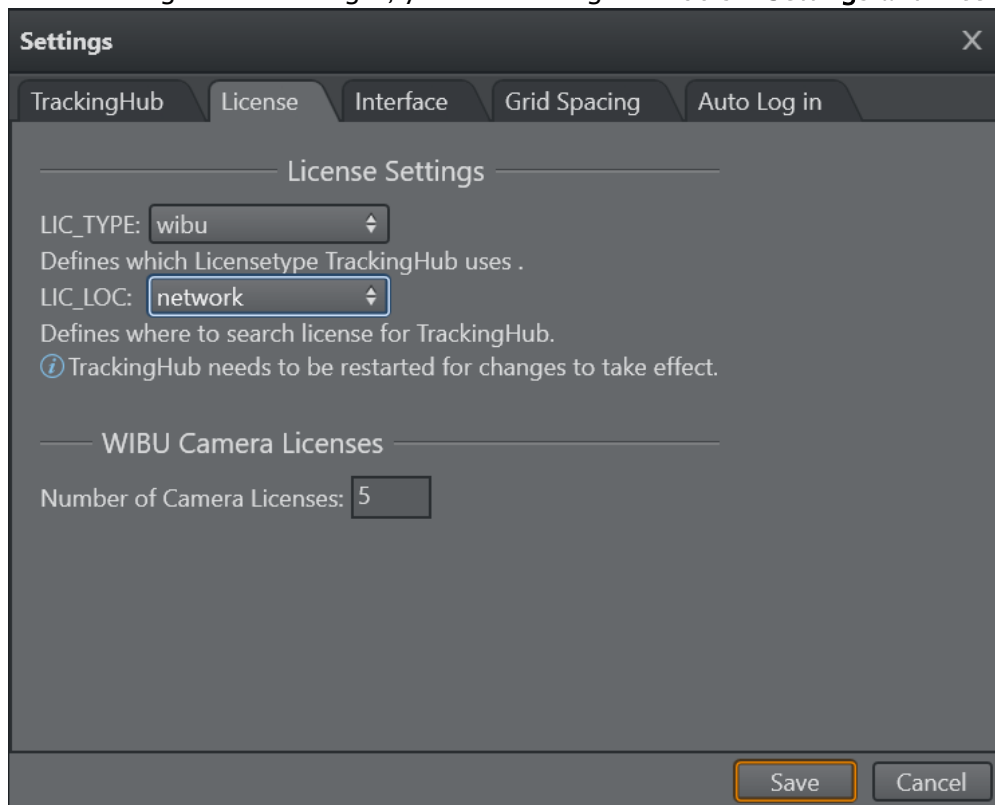

- **LIC\_Type:** Selects what kind of license system you are going to use.
  - **wibu:** For the WIBU Codemeter based licensing system.
- **LIC\_LOC:** Defines where Viz Virtual Studio acquires a license. Possibilities are:
  - **local:** Only to be used for WIBU dongle or software containers.
  - **network:** If a network server is hosting your licenses.
  - **any:** Either a local or a network license will be used.

**Note:** The Sentinel hardlock option has been removed with version 1.7.0. If you still use a Sentinel dongle, please contact Customer Success.

After the license has been set correctly, please close Studio Manager, restart Tracking Hub and restart Studio Manger to check if the license got acquired correctly.

Details can be found in chapter [WIBU-based Licensing System](#) and [WIBU License System in Tracking Hub](#).

## Closing Viz Tracking Hub

**Note:** To close Tracking Hub, type `exit` into the console and press **ENTER**.

## 5 Lens File Editor

- [Port Configuration](#)
- [New Lens File Format](#)
- [The Main Window and Contained Areas](#)
  - [Camera Selection](#)
  - [Lens Portlet](#)
    - [File Section](#)
    - [Info Section](#)
    - [Setting Section](#)
  - [Group Portlet](#)
  - [Engine Control](#)
  - [Calibration Scene](#)
  - [Parameter Control and Views](#)
  - [3D View](#)
    - [Navigation in the 3D View](#)
    - [Point and Line Selection](#)
      - [Point Selection](#)
      - [Line Selection](#)
  - [Point Matrix](#)
  - [2D View](#)
    - [Navigation in the 2D View](#)
  - [Shortcut System](#)
- [Troubleshooting](#)

The new Lens File Editor is a web based application hosted by Tracking Hub. It runs independently of Studio Manager or a Viz Engine. To use the Lens file editor, use one of the supported browsers and navigate to [http://trackinghub\\_hostname:9090](http://trackinghub_hostname:9090).

**Note:** The port needs to be configured first in Studio Manager, see [Port Configuration](#).

Alternatively, click on the Lensfile Editor Icon in the toolbar.

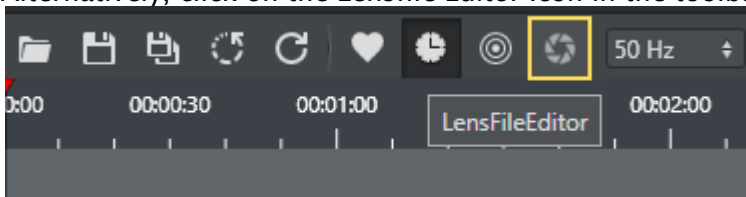

The web browser needs to support WebSockets, Canvas Rendering and WebGL technologies. Please also make sure the configured port is not blocked by any firewall.

The Lens File Editor is currently supported on the following browsers:

- Chrome
- Firefox
- Safari

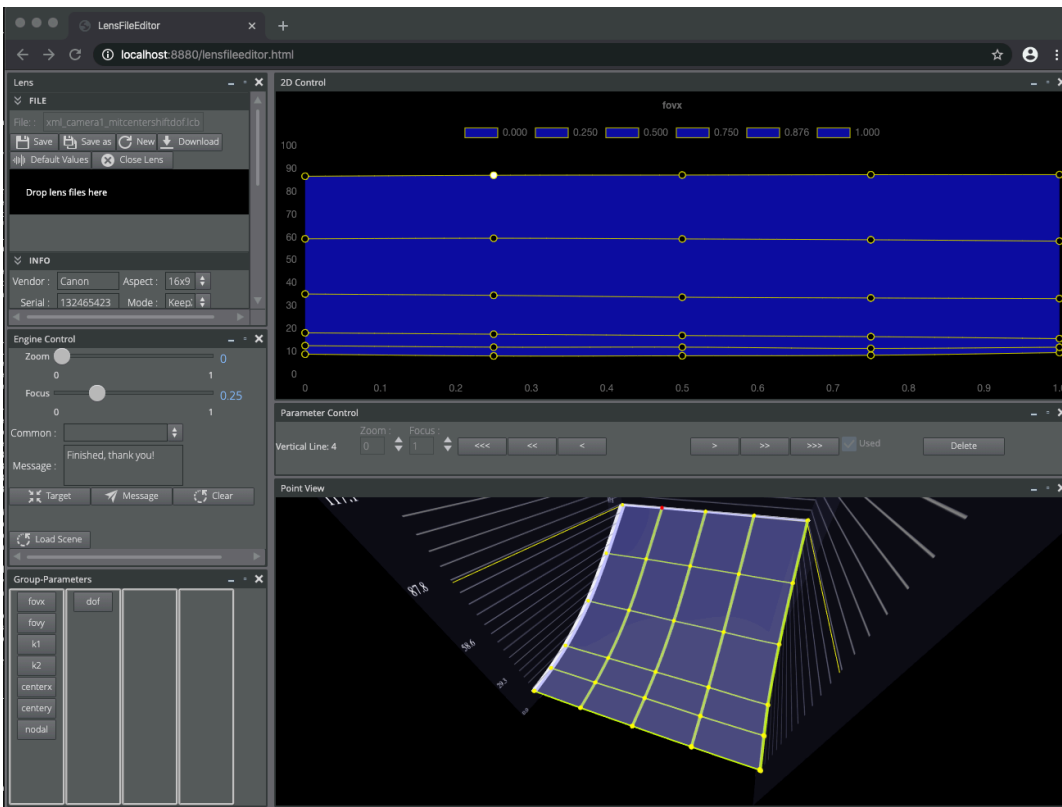

## 5.1 Port Configuration

The port used by the Lens File Editor needs to be configured in the Studio Manager.

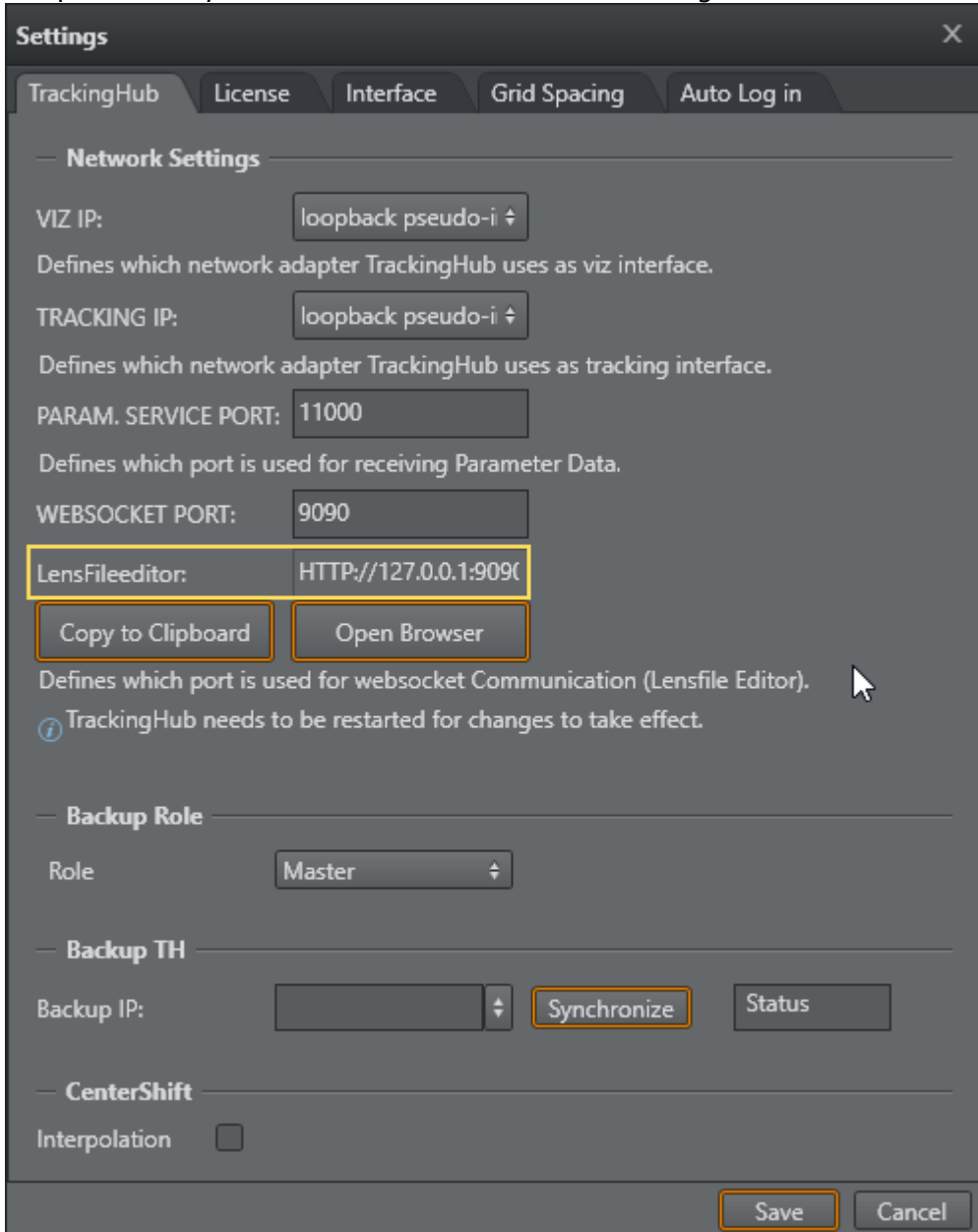

**Info:** Any change of this value is applied immediately without pressing the **Save** button.

## 5.2 New Lens File Format

As the HTML based LensFileEditor uses groups for related parameters, the format of the lens file had to be changed. The new format is human readable XML.

Conversion from the old file format, which was used by Viz Engine and older Tracking Hub versions is done by Tracking Hub during load time. All old lens files found in `C:\ProgramData\vizrt\VizTH\Lensfiles` are automatically converted to the new file format. The original files are moved to a folder named `C:\ProgramData\vizrt\VizTH_ori\Lensfiles\old_lcb`. In Tracking Hub, it is then possible to add a lens file rig, which interprets the new file and send the data to Viz Engine.

## 5.3 The Main Window And Contained Areas

The main window consists of six regions or portals and several modal windows.

### 5.3.1 Camera Selection

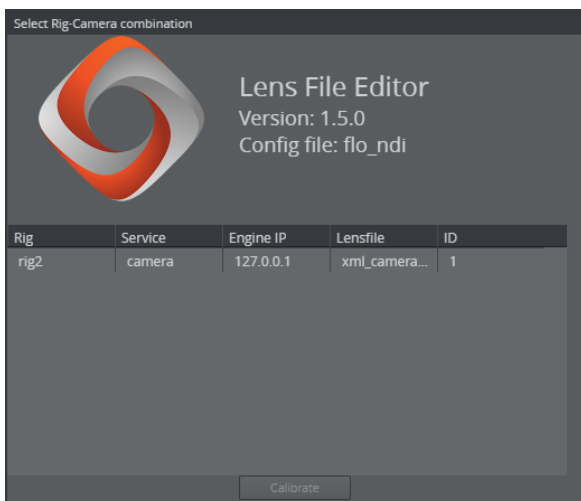

After the connection to Tracking Hub is established, the Lens File Editor shows all lens files, ready to be calibrated. The *Rig*, *Service* and *Engine IP* columns identify uniquely the Rig/Camera combination to be calibrated. The *lens file* column shows the name of the lens file which is loaded in the rig structure. The ID is mainly the ID of the camera service.

A lens file can be attached to more than one service. As soon as the user selects a Rig/Camera combination, a copy of the lens file is loaded into the selected service. All other camera services are not affected.

As soon as a combination is selected, it is locked in Tracking Hub and can not be calibrated from another browser instance. The lock is released as soon as the browser window closes. So it is possible to calibrate different lenses at the same time, but not the same rig/camera combination.

To start a calibration, select one of the table rows and press **Calibrate**. The window disappears and the lens data is loaded into the window.

If the lens file string is empty, a rig with no selected lens file is in the config. If this camera is selected, Tracking Hub loads a template lens file *xml\_empty.lcb* and sends raw file to the editor. The **Save** button is disabled and it is not allowed to overwrite this template. The user must click save as and deliver a new file name.

### 5.3.2 Lens Portlet

The Lens Portlet is structured into three sections.

#### File Section

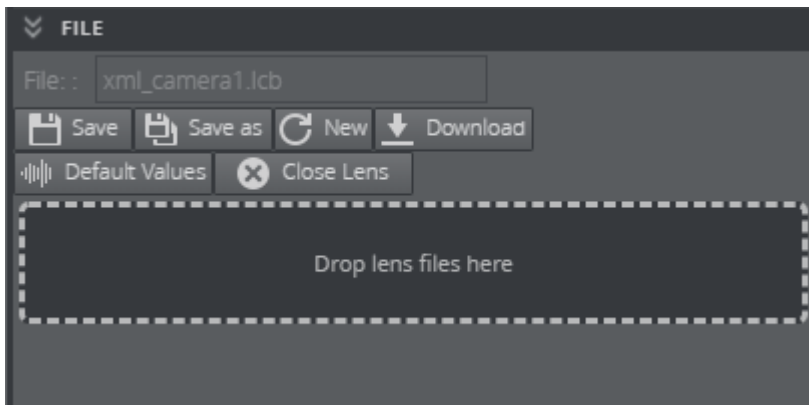

The **Save** button forces Tracking Hub to store the lens data into the *lensfiles/lensfile* folder of the configuration directory. When selecting a combination of Rig/Camera, the name of the lens file is added into the *File* text field. When pressing **Save**, the loaded lens file is overwritten. **Save As** opens a window where the user can enter a new lens file name.

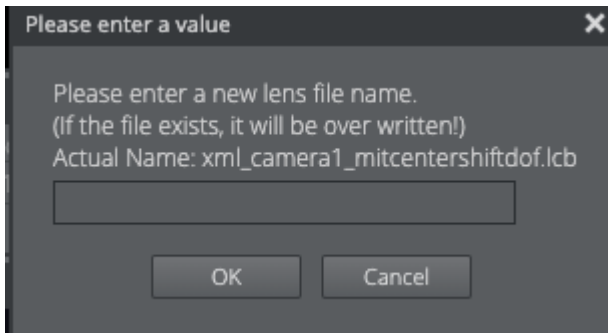

After pressing **OK**, the actual lens is saved on Tracking Hub and automatically loaded. You need to save the configuration in Studio Manager to make the changed lens file permanent in the configuration!

- **New:** Closes the current lens file and allows the user to start with a complete new calibration task. To generate the approximate field of view values you need to enter the focal length and multiplication values in the info section and then press **Default Values** to calculate an approximation.
- **Download:** Exports or shares your lens file. This sends the XML file from Tracking Hub to your local computer.

- **Default Values:** Starts from the beginning by resetting all values back to the default ones. The filename stays the same.
- **Close Lens:** Releases the file lock from this lens and close the calibration process. The user is presented with a dialog to select a new rig.

If you want to use an existing lens file, you can upload it to Tracking Hub by using the Drop zone. Simply drop a XML lens file to use it inside Tracking Hub. After dropping a XML file to the drop zone, a dialog pops up showing the file content as RAW XML file. A user can format it by using the **Format** button once.

**Note:** You need to press the **Reload** button in Studio Manager to select a new created lens file.

## Info Section

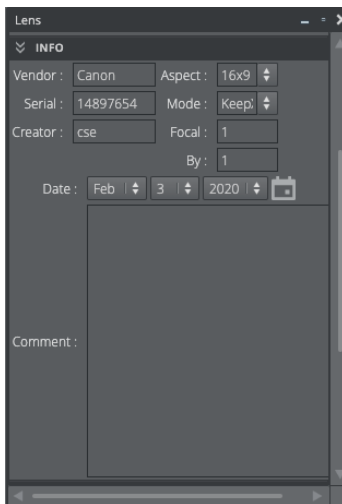

All fields should be filled with care, especially the *Focal Length* and *Focal Multiplier* fields. In case of a new lens, the Lens File Editor calculates base FoV values out of this information. The dialog only accepts float numbers in the *Focal Length* and *Focal Multiplier* fields. The Aspect mode defines if the lens is used as 16x9 or 4x3.

**For clarification:** Tracking Hub calculates the field of view X value from field of view Y. During calibration, this value defines how Tracking Hub adjusts these values during dragging a point. Later on and during operation, this value is defined in the lens file rig of Tracking Hub.



## Setting Section

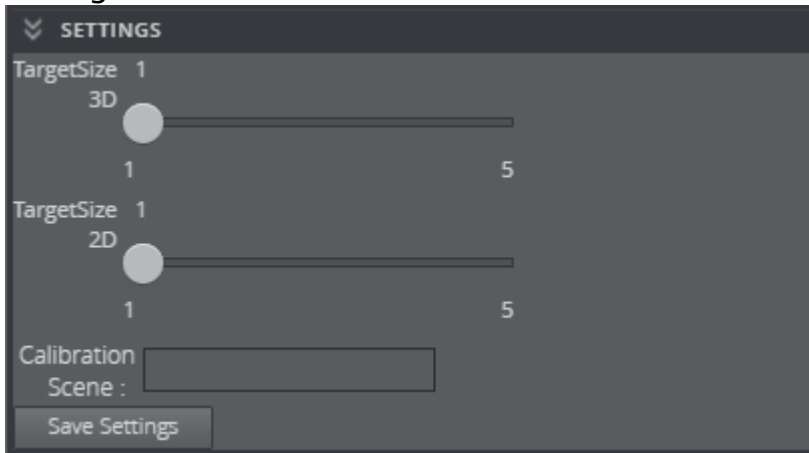

In the settings section the user can adjust the point size of the 3D and 2D view.

This calibration scene is not installed with Tracking Hub and has to be added manually if needed. Its location path can be set in the UI field. Best practice is to enter the UUID of the scene there. This is the scene loaded when using the **Load Scene** button in the Engine Control Section.

By pressing **Save Settings**, these settings are saved as cookie in your browser.

### 5.3.3 Group Portlet

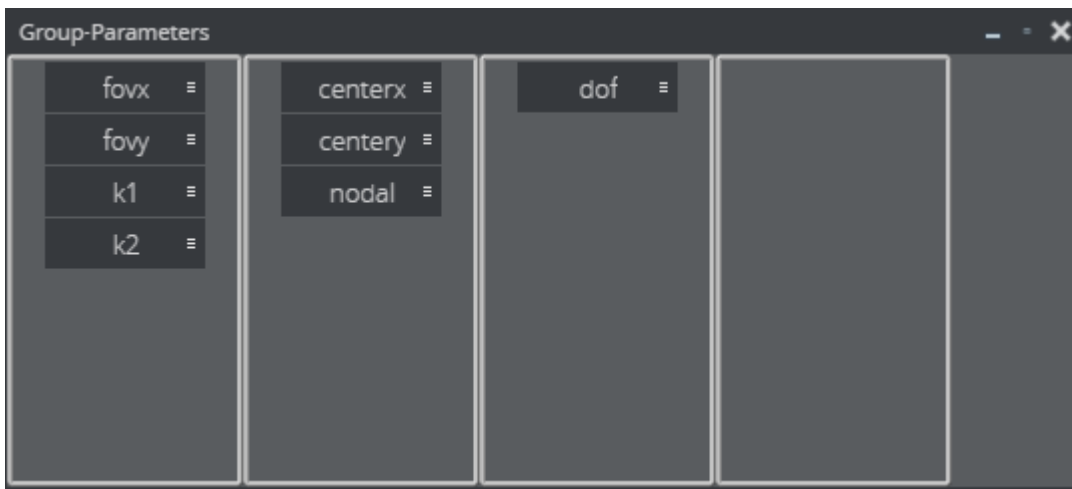

The new Lens File Editor introduces the new concept of parameter groups. The old Lens File Editor had only the principle of measure points.

While *field of view* (FOV) and deformation parameters *k1* and *k2* have to be adjusted for even minor zoom and focus changes, *center shift* and *nodal point values* don't show this sensitive behavior. For these parameters only a few calibration points are needed, whereas for FOV at least 25 (5x5) or more measure points are necessary. These points are defined by the crossing of horizontal and vertical zoom and focus lines which can be moved, deleted and inserted at any time during calibration.

By moving a parameter from a 7x7 group into a 2x2 group, only four parameters are mapped into the new group.

✔ **Tip:** Always create the groups before you start calibration.

### 5.3.4 Engine Control

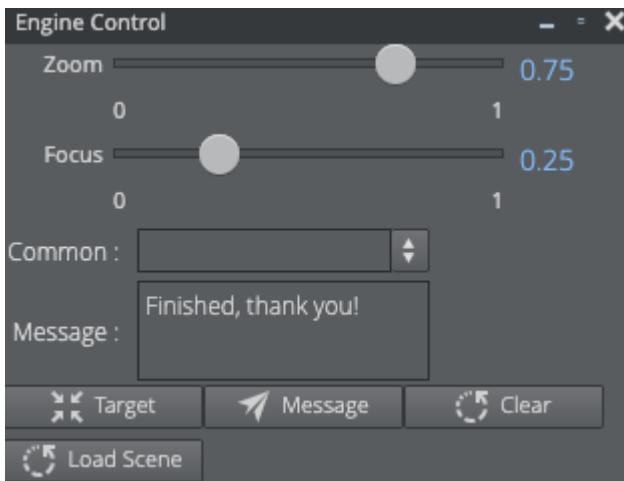

The Engine portlet works in combination with the calibration scene.

It is also possible to select one of the common messages in the *Common* drop box or enter any other message in the *Message* text field. By clicking the **Send Message** button, the message is displayed on the Viz Engine screen. The message can be cleared by clicking the **Clear** button.

The **Load Scene** button forces Viz Engine to load the scene, the user entered in the *Calibration Scene* field of the settings section.

⚠ **Important:** The calibration scene is for Viz Engine Classic Render Pipeline only. Please make sure your scene uses a Classic Pipeline scene in the Main layer.

### 5.3.5 Calibration Scene

Viz Tracking Hub comes with a default calibration scene (as viz Archive). This scene has been designed to be used with the Lens File editor and allows interaction with the person operating the camera.

ℹ **Info:** The archive of this scene is located on the FTP Tracking Hub download folder.

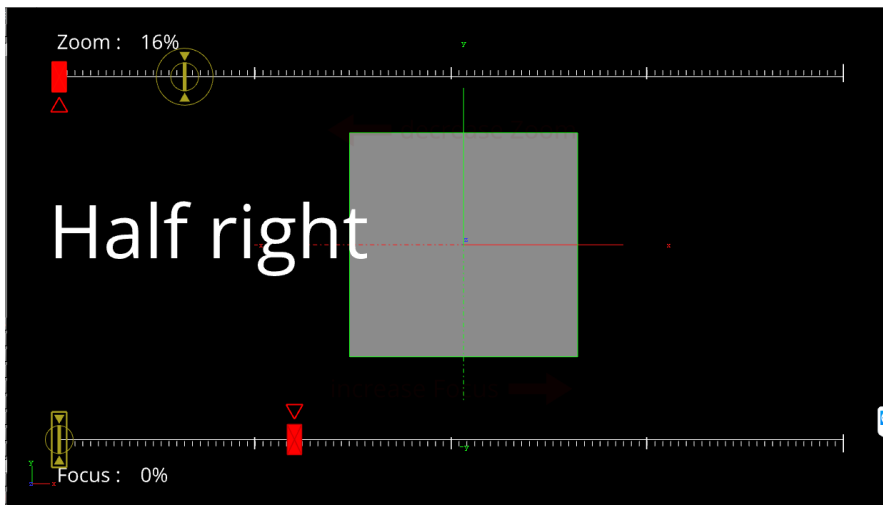

**Info:** The scene is loaded into the Front Layer of Viz Engine by default.

The scene must be imported into the database and then loaded into the Front Layer of Viz Engine. In combination with the Engine Control portlet, the person running calibrating the lens can communicate with the camera operator.

This special scene shows the target points that need to be calibrated by changing zoom and focus values and visually assist the operator. New target points can be sent to Viz Engine using the **Send** button. Whenever a new point is selected, whether in the 2D or 3D portlet, the new zoom and focus values are set in the *Zoom* and *Focus* fields of the Engine portlet.

### 5.3.6 Parameter Control and Views

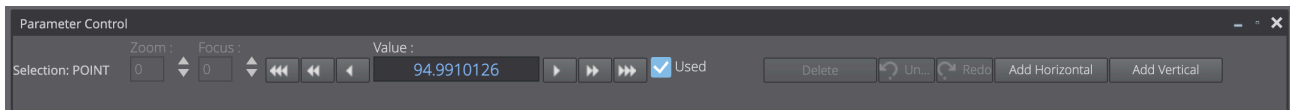

The Parameter portlet and the 2D and 3D views work close together. Whenever a point or line is selected in the views, the parameter control changes to the selected value and reflects all possible input on the selected objects.

The 3D View Control adjusts the minimal, maximal and scale value of the displayed data in the 3D View. Usually, these values don't need to be changed, because the 3D view is linked to the 2D view. In rare cases, if the user wants to inspect a special point or region of the lens, these values can be used.

- **Min:** The minimum, bottom of the displayed data.
- **Max:** The maximum, top of the displayed data.

The 2D View Controls the user can select the diagram type of the 2D display. Type can define two values: Zoom and Focus:

- **Focus:** The X axis defines the focus range (0 to 1), while the Y axis shows the value of the calibrated points.
- **Zoom:** The X axis defines the zoom range (0 to 1), while the Y axis shows the value of the calibrated points.

During calibration the focus diagram is the preferred one.

In case of a selected point, the value of the point can be modified. The modify divisor defines the amount of change, when the user clicks on the up and down button of the value. The base of this value is defined as the zoom area in the 2D and 3D view. **10** means, that the value is increased or decreased the zoom are divided by 10, 100 or 1000. This is valid for line movement as well.

A selected line can be moved between its left and right, or upper and lower neighbor. The Modify Divisor again defines the step size of the movement.

As soon as a point has been modified, the point is displayed in yellow and its value is used in the spline interpolation. This yellow state can canceled by unchecking the *Used* checkbox. Unchecking *Used* activates the blue state of the point and its value is defined from the calibrated points around.

### 5.3.7 3D View

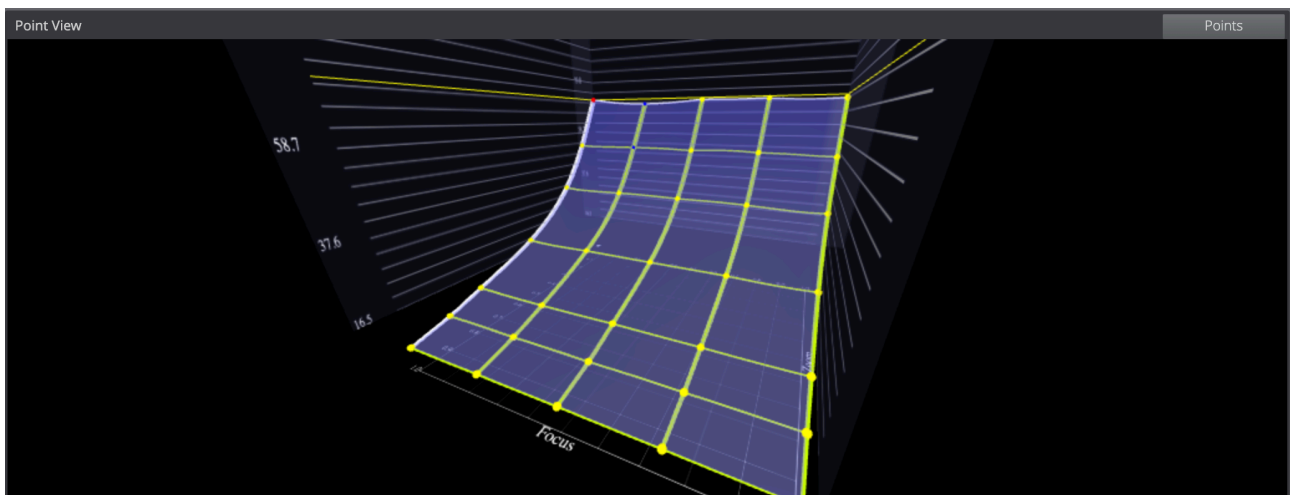

The 3D View shows the lens in a 3D Diagram. Focus is drawn in the X-Axis, Zoom in the Z-Axis. The lens is drawn as a blue surface, and the measure points as Spheres. Depending on the status of the measure points, different colors are used.

By clicking on the **Points** button, the display can be changed to a 2D view of the measure points. The usage is described in the next section.

#### Navigation in the 3D View

Rotate the view by clicking into the View, hold the mouse button and drag the mouse. Move the view by clicking into the view, hold the mouse button and press **SHIFT**.

- **Zoom:** Zoom in and out with the mouse wheel.

#### Point and Line Selection

A point can have four statuses:

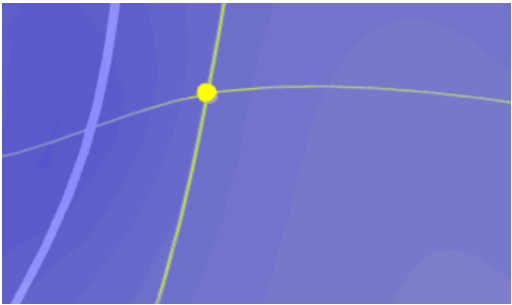
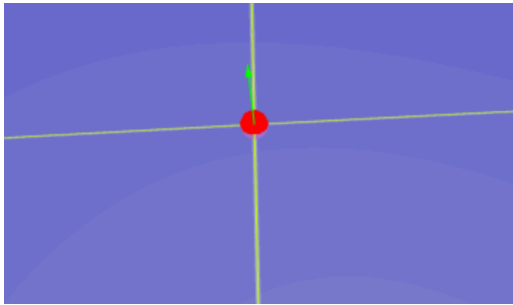
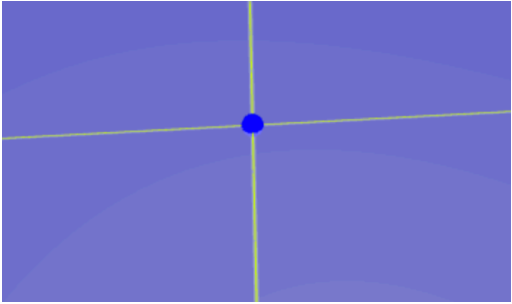
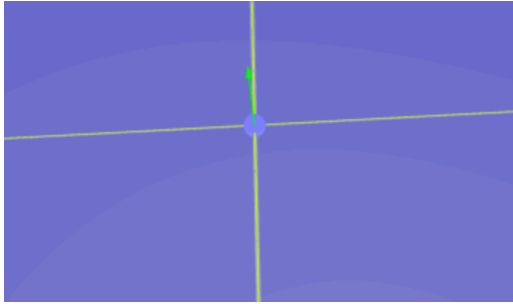
	
<p>A mandatory point is drawn as yellow sphere.</p>	<p>When the point is selected its color changes to red.</p>
	
<p>A point which is not mandatory and was untouched is drawn in blue: Such points are calibrated only if needed.</p> <p>If untouched the point is placed on the surface of the spline. A selected, untouched point is drawn as light blue. As soon as the point is moved by the operator it changes to touched.</p>	<p>After selecting a point, an arrow handle is displayed over the point. By clicking and dragging the arrow, the value of the point can be manipulated.</p>

### Point Selection

Clicking at the point selects the point and changes the parameter control.

### Line Selection

By hovering over a line, a red indicator is displayed. A new line can be inserted by **SHIFT + Left-clicking** on the line.

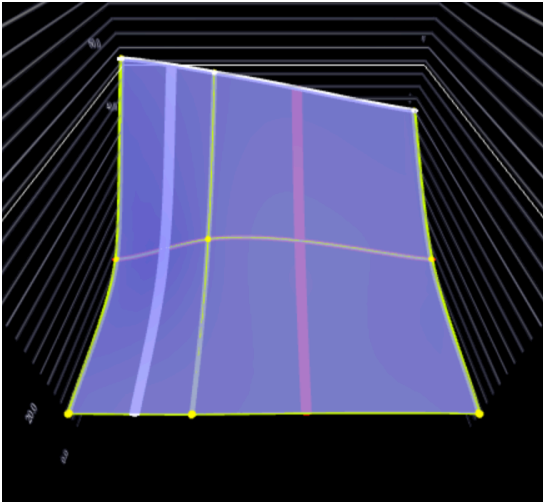

A line can be deleted by hovering over it, and press **D** on the keyboard.

A line can be moved, by hovering over it, and Left Mouse click on the line. In the Parameter Control, the zoom or focus value can then be modified (border lines can not be moved).

### 5.3.8 Point Matrix

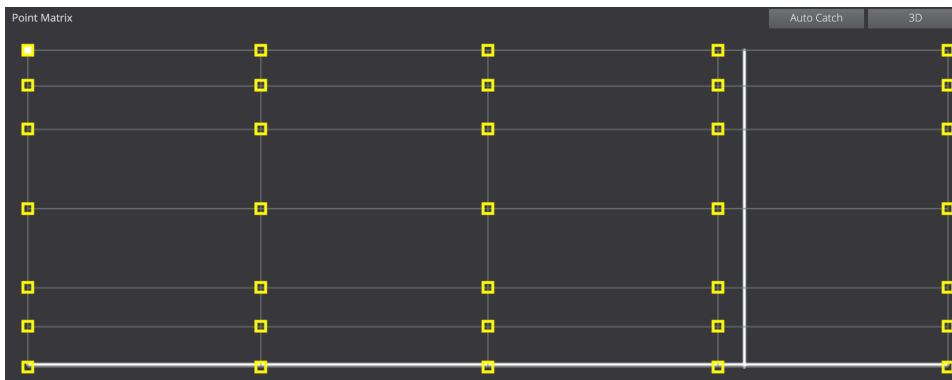

The point matrix displays all points and lines of a group. The x-axis represents the focus and the y-axis the zoom value of a point. Zoom and Focus are normalized to the width and height of the Portlet. Points can be selected by clicking on the rectangle. Lines can be selected by clicking on them.



If the **Auto Catch** functionality is activated, the point under the cross hair is selected when the distance of zoom and focus of the point goes under a limit.

By clicking on **3D**, the Point Matrix can be switched to the 3D view, which displays zoom and focus range with the actual values of the measure points. See above for how to operate in this view.

Used points are displayed as yellow rectangles, while unused points are drawn in grey. If a point is selected it is filled with white color.



If a point is selected with the mouse and the cursor is moving, the cursor is drawn in red when the zoom and focus are out of range of the point. As soon as the cursor goes into the modification range, it is drawn in white.



### 5.3.9 2D View

The 2D View is the main view used for calibrating the lens points. Clicking into a point selects the point in 2D View and 3D View. Dragging the point manipulates the value. Using the mouse wheel, the user can zoom in and out (and increase the accuracy of the manipulation).

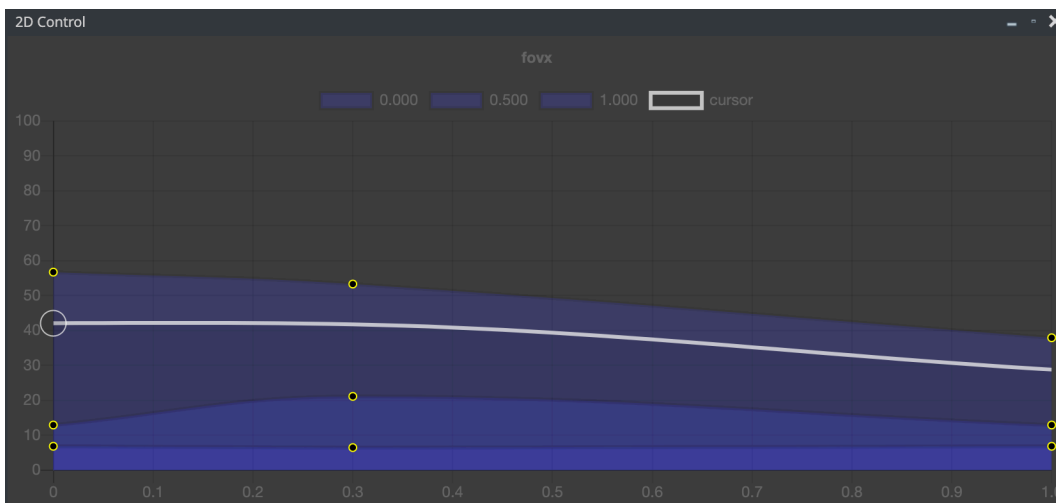

#### Navigation in the 2D View

- **Move:** Click with the mouse in the 2D View, press **SHIFT**, keep the left Mouse Button pressed and move the mouse. This moves the diagram.
- **Zoom:** Use the mouse wheel to zoom in and out.



### Different States of Points

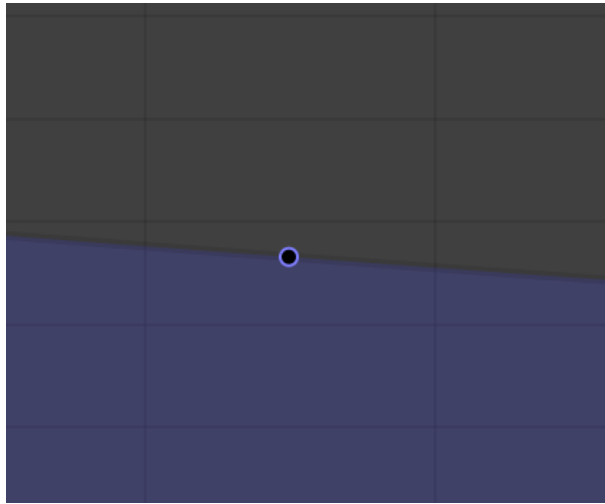

A point which is not mandatory and was untouched.

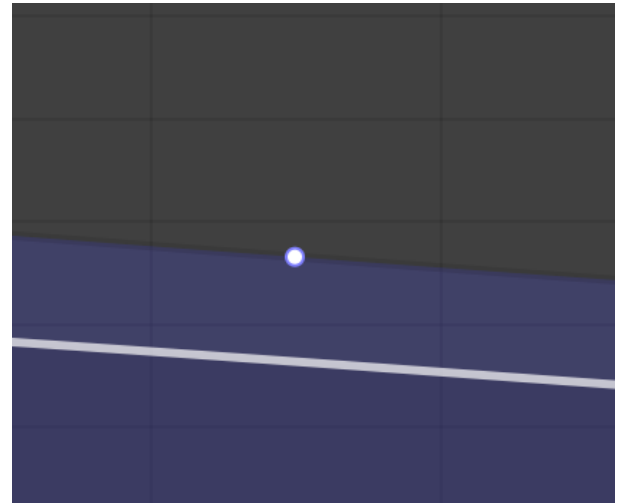

A point which is not mandatory, untouched and selected.

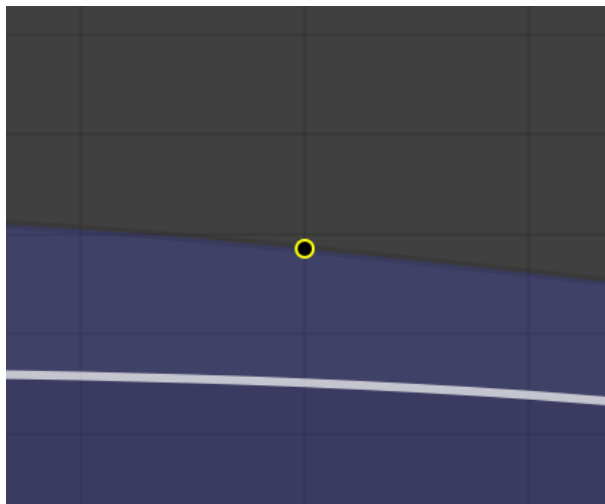

An unselected mandatory or touched point.

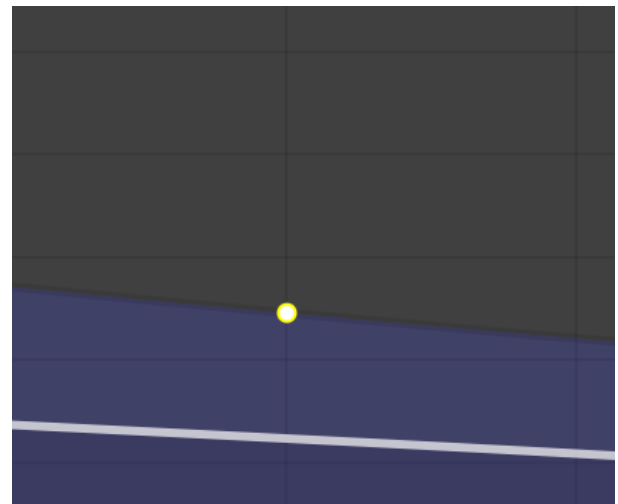

A selected mandatory or touched point.

The 2D view can be switched between **Zoom** and **Focus** mode (upper right)

### 5.3.10 Shortcut System

The lens file editor implements a shortcut system, which enables the user to operate the editor with keyboard shortcuts only.

Shortcut	Change Parameter
CTRL + 1	Field of View X

Shortcut	Change Parameter
CTRL + 2	Field of View Y
CTRL + 3	K1
CTRL + 4	K2
CTRL + 5	Center X
CTRL + 6	Center Y
CTRL + 7	Nodal
CTRL + 8	Depth of field
Q	Increases the value of the selected point for 1/1000th of its actual value
A	Decreases the value of the selected point for 1/1000th of its actual value
W	Increases the value of the selected point for 1/100th of its actual value
S	Decreases the value of the selected point for 1/100th of its actual value
E	Increases the value of the selected point for 1/10th of its actual value
D	Decreases the value of the selected point for 1/10th of its actual value
ALT + Cursor Keys	Moves selected point for one row or column

## 5.4 Troubleshooting

If you are not able to connect locally to the lens file editor web page, please verify the proxy settings of Internet Explorer.

## 6 Studio Manager GUI

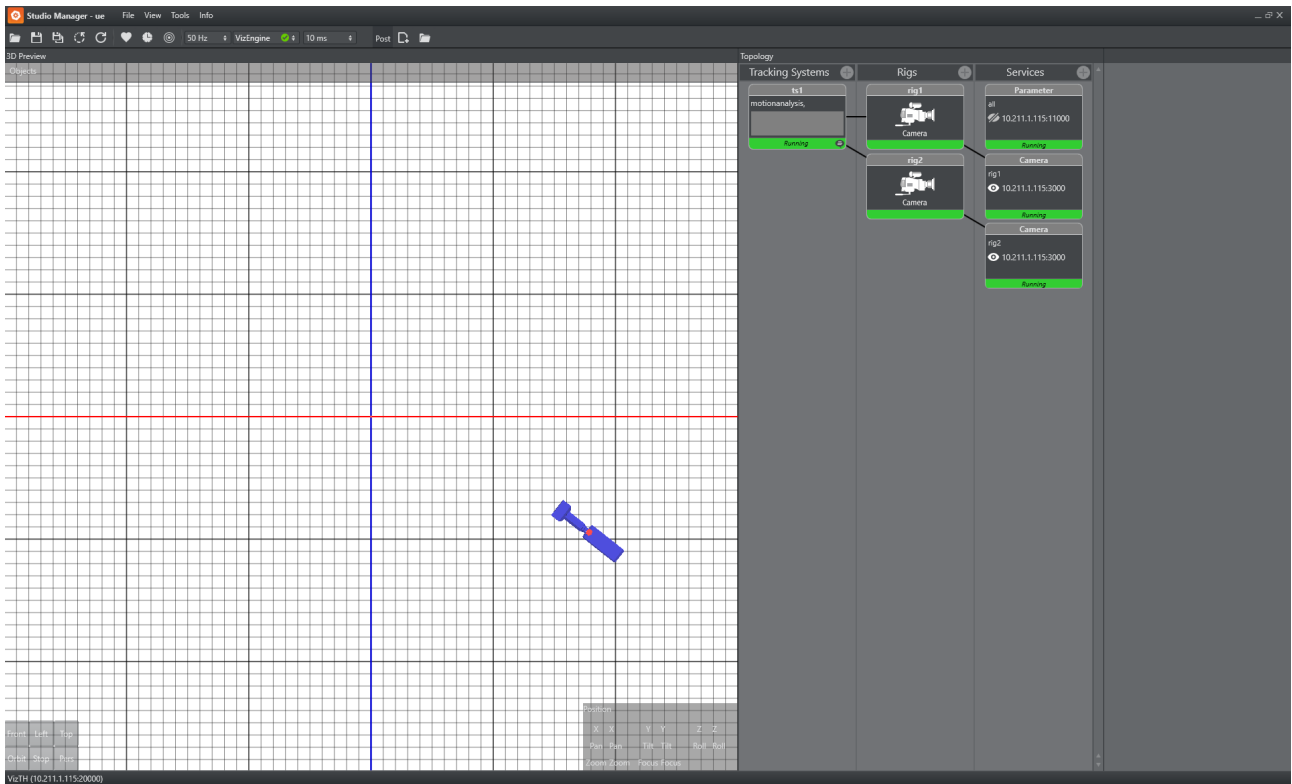



This section details each of the Studio Manager panels and their properties:

- [Configuration Panel](#)
- [Parameter Panel](#)
- [Topology Panel](#)
- [Log Panel](#)
- [Timing Analysis Window](#)
- [Preview Panel](#)
- [Post System](#)
- [Data Flow Inspector](#)

### 6.1 Configuration Panel

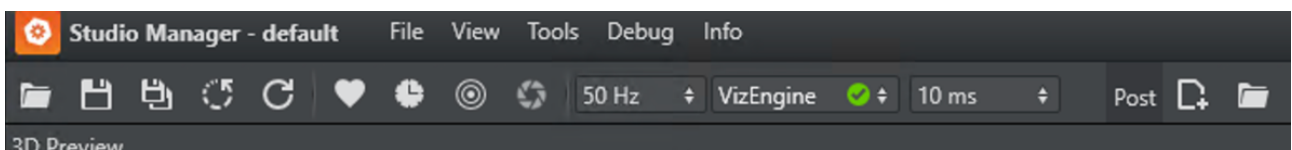
Use the **Configuration Panel** to save and load Studio configuration profiles, select modes of operation including frequency, and to set some user interface options.



- **Open:** Opens a Tracking Hub configuration file. The name of the currently loaded configuration file is always displayed in the top bar, between the application name and main menu.
- **Save:** Saves the current Studio configuration.
- **Save As:** Saves the current Studio configuration with a new name.
- **Reset:** Resets the current Studio configuration. Note that the loaded configuration file is only changed if you click **Save** after resetting the configuration.
- **Refresh:** Reloads the actual configuration. Use this to apply any changes third party software has made to the Tracking Hub parameters, so that the changes can be visualized in the Studio Manager.
- **View Log:** Opens or closes the [Log Panel](#).
- **View Timing Analysis:** Opens the [Timing Analysis Window](#).
- **LensFile Editor:** Opens the [Lens File Calibration Tool](#).
- **Frequency:** Selects the production frequency:
  - 50 Hz , 60 Hz or
  - 59.94 Hz , 29.97Hz , 30 Hz , 25 Hz , 24 Hz .
- **Synchronization Mode:** Selects synchronization mode for the Tracking Hub:
  - **Freerun:** Does not synchronize. The Tracking Hub uses its own time base, corresponding with the configured frequency.
  - **AV-Card:** Uses an installed *Plura* card to synchronize.
  - **Viz Engine:** Synchronizes with a Viz Engine running on the same computer.
  - **NDI:** Please see: [Embedded NDI Tracking Data](#)
-  **Tip:** If the selected synchronization mode is followed by a red box with a white horizontal line, this indicates synchronization issues.
- **Send Delay:** Sets the time Tracking Hub waits until it sends tracking data to Viz Engine. This setting is especially important if your tracking delay is less than one field. With the help of the Timing Analysis, the transmission time can be set after the arrival of the tracking data. If your tracking delay is larger than one field, set the send delay value to **No Delay**. This reduces the CPU usage.

### See Also

- [Parameter Panel](#)
- [Topology Panel](#)
- [Log Panel](#)
- [Preview Panel](#)

---

## 6.2 Parameter Panel

The Parameter Panel shows the configuration parameters for the selected Topology item: Tracking Systems, Rigs and Services.

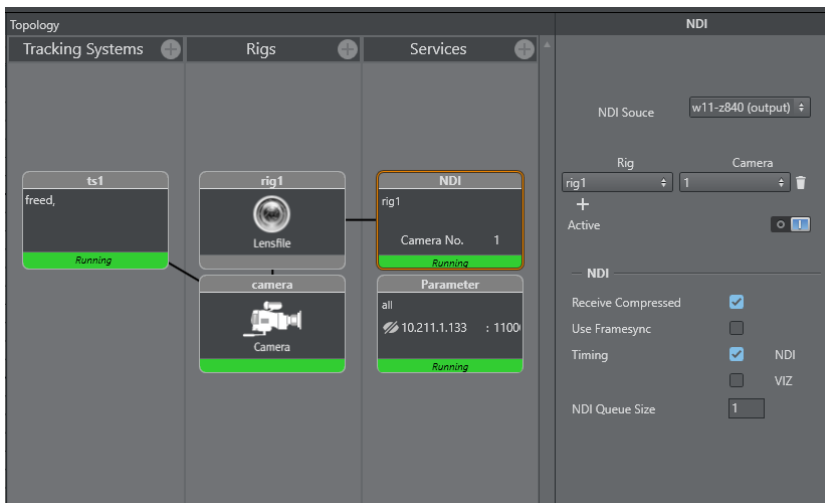

Click on a Tracking System, a Rig, or a Service, to view or change its parameters as required.

## 6.3 Topology Panel

- [Tracking Systems](#)
- [Rigs](#)
- [Services](#)
- [Topology Connection Lines](#)
- [Topology Colors](#)
- [Motion Capturing with Motion Analysis](#)

The Topology Panel shows a representation of the tracking systems, the connection to a Viz Engine and which Viz Engine services are in use.

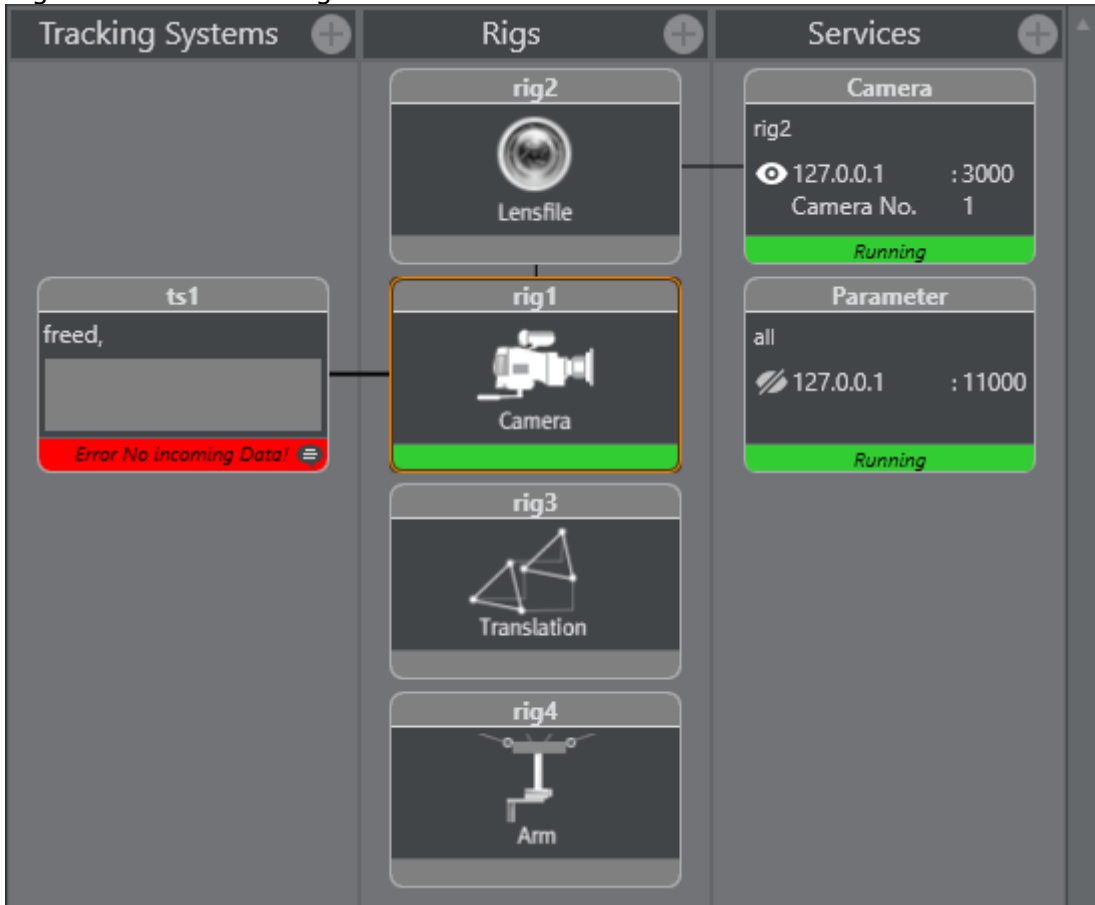

### 6.3.1 Tracking Systems

The Tracking System panel represents the tracking software in the studio. Click on a tracking system icon to view its properties (see [Parameter Panel](#)). A line from the tracking system represents a connection to a Rig.

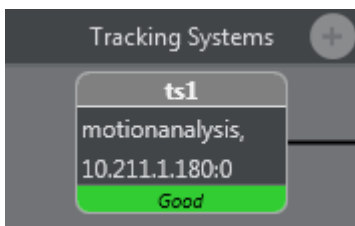

Right-click Menu:

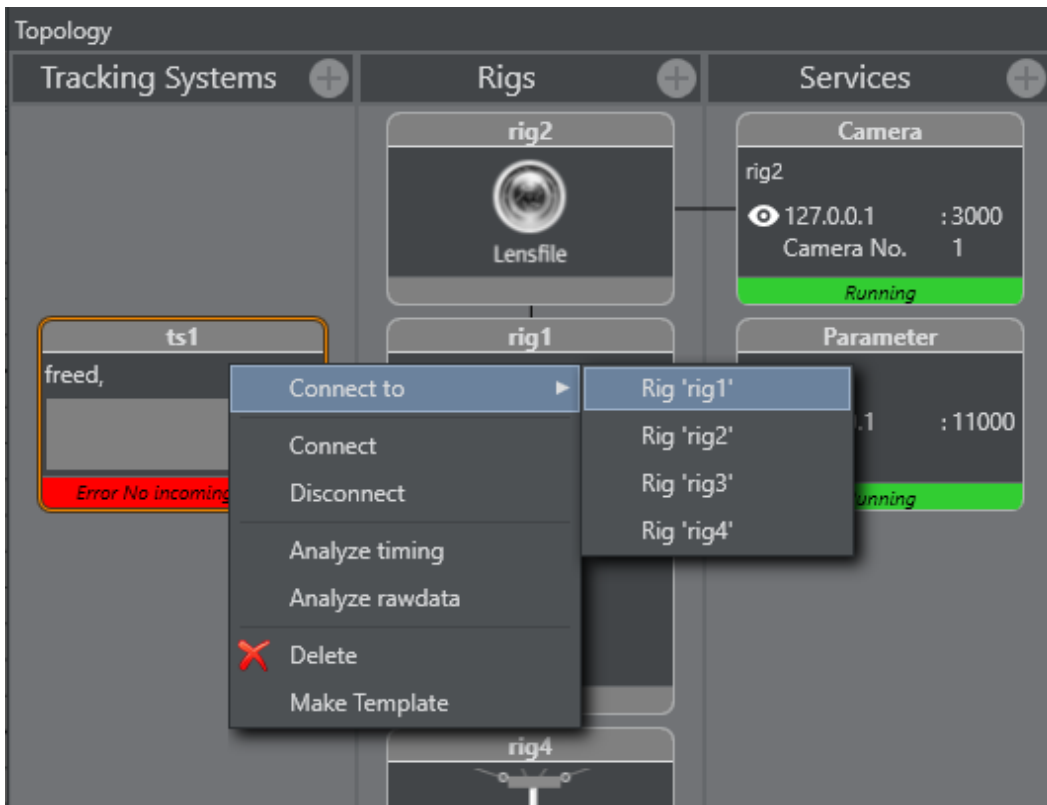

- **Connect to:** Connects to a Rig.
- **Connect/Disconnect:** Connects to or disconnects from the tracking system.
- **Analyze timing:** Shows time analysis.
- **Analyze rawdata:** Enables or disables the collection of raw data for analytical purposes.
- **Delete:** Removes the Tracking System.

## 6.3.2 Rigs

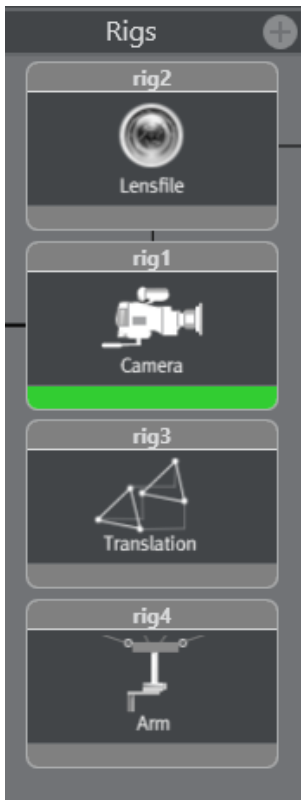

A Rig is the interface between the Tracking System and Viz Engine. Click on any Rig icon to view its properties (see [Parameter Panel](#)). A line from a Rig on the left represents a connection to a tracking system (see Tracking Systems). A line from a Rig on the right represents a connection to a Service (see Services).

Rigs are defined as the following types:

- Translation
- Arm
- Crane Head
- Location Pivot Rotation
- Pivot Rotation
- Camera Standard (rotation order YXZ Pan - Tilt - Roll)
- CameraXZY (rotation order YZX Pan - Roll - Tilt)
- CameraYXZ (rotation order ZXY Roll - Tilt - Pan)
- CameraFD (special design for Spidercam construction)
- Object
- Extended LensParameters
- Lensfile
- Lensfile Focal Distance
- Gimbal Camera



The Translation rig is for position data only, and provides the Tracking Hub with the following parameters:

- pos\_x
- pos\_y
- pos\_z

The Arm rig can be rotated in three dimensions, and starts with a swivel. It has a defined length with a defined direction, and offsets between swivel and length. Both the Translation and Arm rigs are used for camera systems such as Spidercam:



The Location Pivot Rotation rig is a rotation interface in the X-Z dimension, with center point (0/0). Pivot Rotation is a rotation rig with a definable center point. The rig provides the Tracking Hub with the following coordinates:

- pivotx
- pivoty
- pivotz

Camera is a basic rig for tracked cameras. Object is a basic object for tracked objects.

### 6.3.3 Services

A Service is the element of a Viz Engine which is connected to the Tracking System through the Rig. Click on a Service icon to view its properties (see [Parameter Panel](#)). A line from the a Service represents a connection to a Rig (see Rigs).

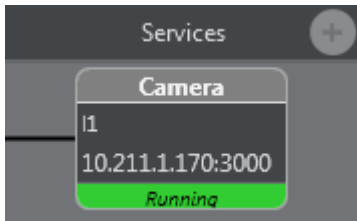

Available Services are:

- **Camera:** Tracks a camera for Viz Engine.
- **Object:** Tracks an object with Viz Engine.
- **Parameter:** Provides all required data for the creation of the 3D View.
- **MoCap:** Captures motion for Viz Engine.
- **Communication Timing:** Sends timing information which are measured during tracking data acquisition.
- **Tracking Timing:** Sends timing information which are measured during sending the data as service to Viz Engines.
- **Timecode Service:** Used for post and replay.
- **Multi Object Service:** For TrackMen object tracker.
- **Tracking Flow and Tracking Flow Raw Service:** Used to analyze incoming tracking data.
- **NDI Service:** Used for embedding tracking data into NDI stream.
- **TC Camera:** Used by the Viz Libero System.

Right-click display object for additional menu:

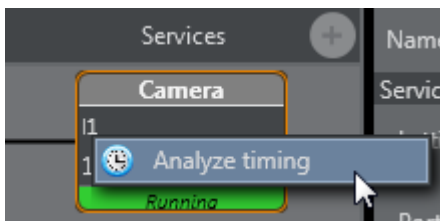

- **Analyze timing:** See Analyze Time.

### 6.3.4 Topology Connection Lines

The Topology Connection Lines show the connections between each item in the Topology. Double-clicking a Topology connection line between a Tracking System and a Rig opens the Tracking parameter routing window for the connection:

Tracking System "tsspider"		Rig "richi"				
Tracking parameter	Connected	Name	Inverted	Offset	Delay	
tsspider_pan	tsspider_posx x	PosX	<input type="checkbox"/>	0	0	
tsspider_tilt	tsspider_posz x	PosY	<input checked="" type="checkbox"/>	135	0	
tsspider_zoom	tsspider_posy x	PosZ	<input checked="" type="checkbox"/>	0	0	
tsspider_focus						
tsspider_gyrox						
tsspider_gyroz						
tsspider_gyroy						
tsspider_posx						
tsspider_posz						
tsspider_posy						
tsspider_iris						

### 6.3.5 Topology Colors

The colors of the icons in the Topology view show the working condition:

- **Green:** Everything is OK and in regular working condition.
- **Grey:** The tracker is not connected or deactivated.
- **Orange:** The Service or Tracker state is in warning condition. See the log or message for more information.
- **Red:** The Service or Tracker state has a serious error. See log or message for more information.

### 6.3.6 Motion Capturing with Motion Analysis

Motion Capturing is a special way of collecting and forwarding data to an Engine. This mode transmits movements of a person or people instead of camera positions. For these special procedures, there is a new rig and a new service available.

Selectable via the menu:

- Rigs > Add MoCap
- Services > Add MoCap service

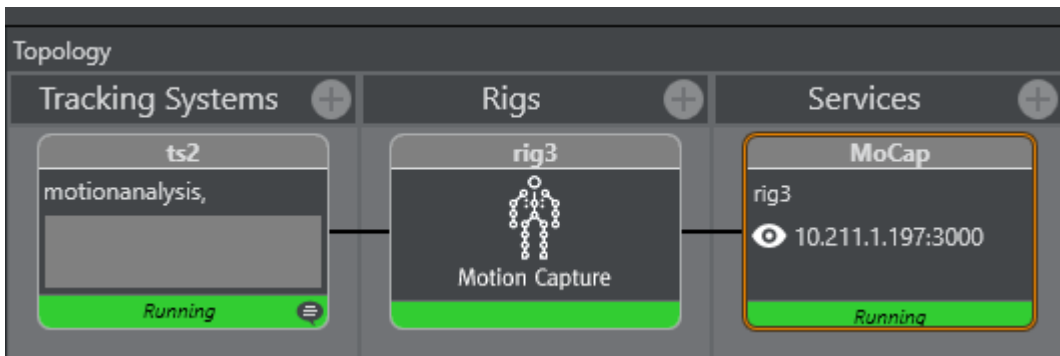

Connect the Motion Analysis Tracking System to the MoCap Rig as usual.

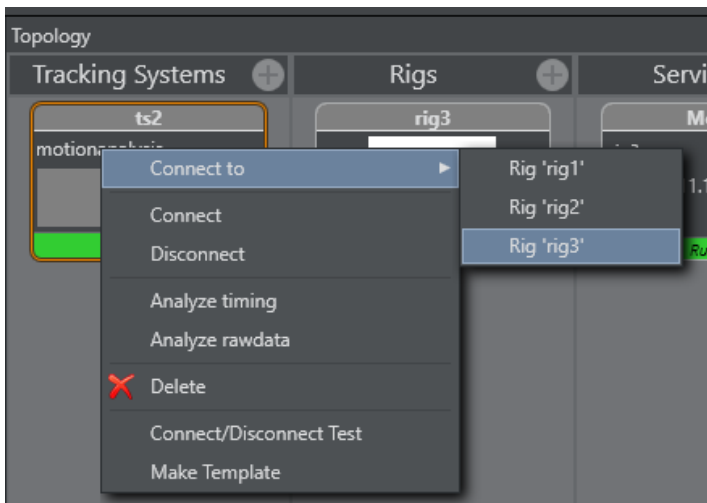

In this case, there is just one axis available.

Tracking parameter routing						
Tracking System	Rig					
"ts2"	"rig3"					
Tracking parameter	Connected	Name	Inverted	Offset	Delay	
ts2_chris_mocap	ts2_chris_mocap ×	mocap	<input type="checkbox"/>	0.00	0.00	



The name of the axis depends on the used name in MA's Cortex. Mocap Service can be used as other services.

## 6.4 Log Panel

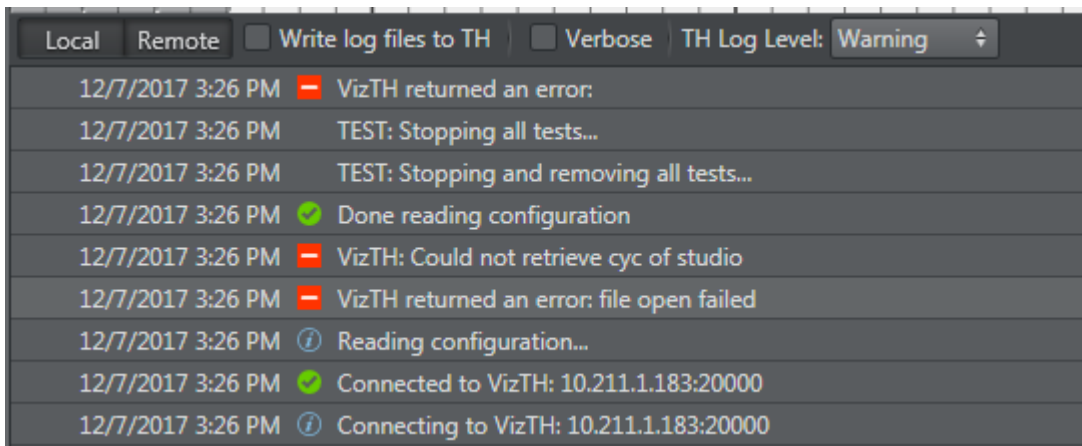
The Log panel provides messages and notifications from the Tracking Hub. The bottom line displays information about which Tracking Hub the Studio Manager is connected to. You can open and close the Log panel by clicking **View Log** in the [Configuration Panel](#).



You can copy each entry in the Log Panel to the clipboard by right-clicking the entry and selecting **Export message to clipboard**. The information can be copied to the clipboard as plain text or as XML encoded text.



-  **Export Log to a file...:** Exports the log file as XML or as plain text.
-  **Delete Log Entries:** Clears all log messages from the window.
- **Write Log File on VizTH:** Makes the Tracking Hub write a time-stamped log-file for all tracking data received and sent to Viz Engine when selected. Additional Timing information is logged as well. The log-files are:
  - *VizTH\_rcv1.txt*
  - *VizTH\_send1.txt*
  - *VizTH\_timing1.txt*
 Log-files are located in *C:\ProgramData\vizrt\VizTH*. If the log-file size reaches 1 MB, a new file is created with an incremented number.
- **Local Remote**: Changes the view of the debug output between the Studio Manager or the connected Tracking Hub.
- **Verbose:** Enables verbose logging when the check-box is selected.
- **TH Log level:** Use the drop-down menu on the right side to select log level:
  - **Fatal:** Displays only fatal errors (lowest log level).
  - **Error:** Displays Fatal and Error messages.
  - **Warning:** Displays Fatal, Error and Warning messages.
  - **Information:** Displays Fatal, Error, Warning and Information messages.
  - **Debug:** Displays Fatal, Error, Warning, Information and Debug messages.
  - **Verbose:** Displays all messages (highest log level). In certain situations, these messages cannot be written to the console. In such cases, they are written to the log file only.

Messages are shown in the console and written to *VizTH.log*. From Level **Fatal** up to **Information**, the debugs are shown in the console and are written to the *VizTH.log*.

---

## 6.5 Timing Analysis Window

The Timing Analysis Window can be opened by clicking the View Timing Analysis button in the [Configuration Panel](#). The Timing Analysis Panel contains two tabs: **Tracking** and **Engine**.

- : Starts or pauses the timing analysis.
- : Refreshes the data.

The **Tracking** tab analyzes tracking systems and camera services. In the top half of the panel, timing events are displayed in form of one timing track per tracking system and camera service. The timing events between the latest two sync signals are displayed (i.e. the length of the timing tracks is determined by the studio frequency).

The sync signals are represented by *orange circles*. The next-to-last sync signal rests at the left border of each track, without moving. The latest sync signal may flicker at the right border, and may even be temporarily out of sight, because of timing variations.

- A *blue bar* represents the time needed to receive tracking data.
- A *purple bar* represents the time needed to store the received tracking data.
- A *green bar* represents the time needed for computations on the tracking data to be sent next.
- A *red circle* marks the moment when Viz Tracking Hub has finished sending the tracking data to the connected Viz Engine(s).

In the lower half of the panel, some of the events are plotted over time. The newest events are displayed at the right border and constantly move towards the left border as time passes. Colors correspond to those in the timing tracks in the top half of the panel.

For a specific tracker, timing analysis can be started right clicking the tracker or selecting **Analyze timing** in the open context menu. A service is created to send the timing information to the Studio Manager. To stop the service, either close the created service or deselect **Analyze timing** in the context menu.

The **Engine** tab analyzes the timing reported by Viz Engine (requires Viz Engine version 3.8 or later) on the selected network.

- The *blue bar* represents the minimum (light blue) and maximum (dark blue) time which passed between two sync signals on the Engine.
- The start of the *red bar* is the point in time when the tracking data arrived at the Engine. The end of the red bars indicates the minimum (light red) and maximum (dark red) time

between two incoming tracking packages.

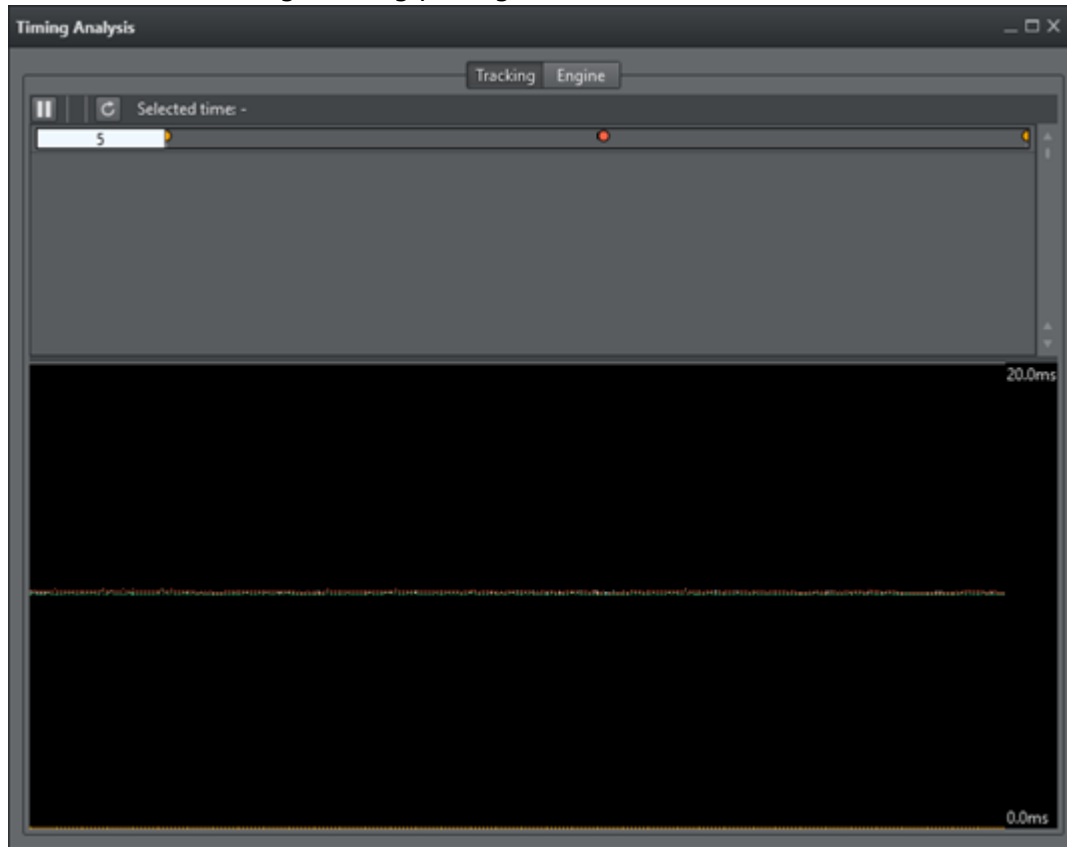

### See Also

- [Configure the Studio](#)
- [Configuration Panel](#)
- [Parameter Panel](#)
- [Topology Panel](#)
- [Preview Panel](#)

## 6.6 Preview Panel

This page contains information about the following topics:

- [Interface Configuration](#)
- [View Menu](#)
- [Navigation](#)
- [HUD](#)
- [Cyclotron Editor](#)
  - [Workflows](#)
  - [Common Cyc-Editor Elements](#)
  - [Back-Wall](#)
  - [One Corner](#)

- Two Corner
- Masks
- CyC Editor Angle and Width
- Examples
- Shape Area
- Cyc
- CoCyc
- Objects Menu
- Selectable Display Modes
- Camera Handles

The 3D Preview panel gives a preview of the tracked cameras, which should be as close to the real studio as possible. When the Studio Manager starts up, a Parameter Service is established, which sends the positions of all tracked rigs to the preview panel.

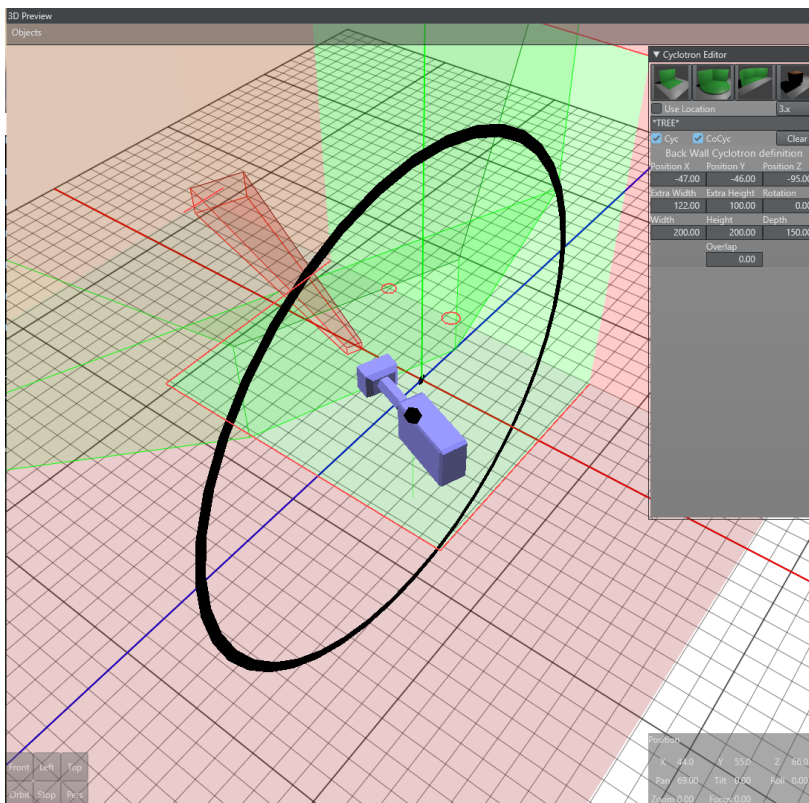

The preview panel consists of the following parts:

- The main menu.
- The navigation bar.
- The HUD display.

### 6.6.1 Interface Configuration

To adjust the colors to a users need, open the Settings window in Tools. In this window, the user can adjust the render colors for the visible objects in the preview panel. Click in a drop-down list



to open the color selection window. The RGB and Alpha values can be adjusted for all colors by clicking the **Advanced** button.

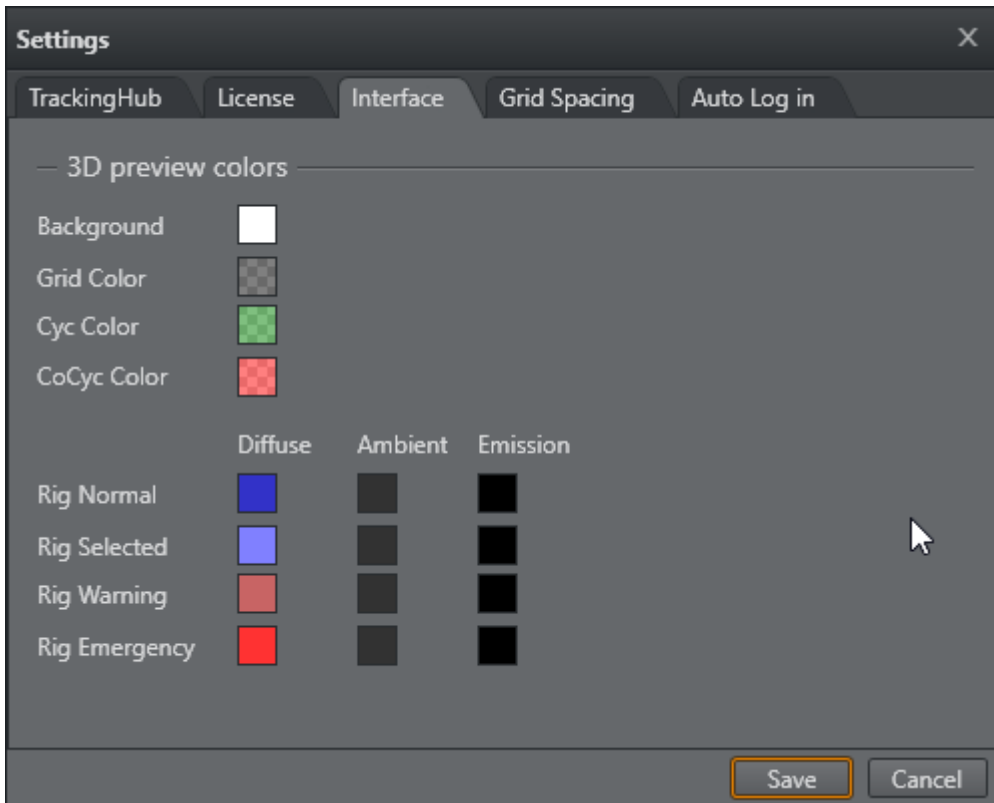

For the Background, Grid, Cyc and CoCyc colors, only diffuse color can be selected. These objects are rendered without lighting.

- **Rig Normal:** Shows colors used when the Rig is not selected. The user can define Diffuse, Ambient and Shininess colors.
- **Rig Selected:** Shows colors used when the Rig is selected in the Rig Editor.
- **Rig Warning:** Shows when a connected Parameter service reports a problem which is handled by the system (interpolation of missing packages).
- **Rig Emergency:** Shows when a Parameter service reports a problem which cannot be handled by the system, and immediate action from the operator is needed.

## 6.6.2 View Menu

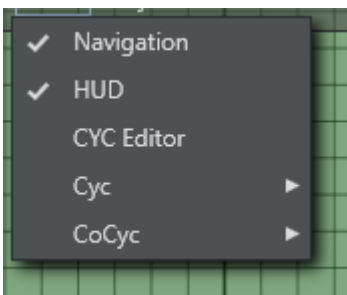

### 6.6.3 Navigation

Activates or deactivates the navigation bar in the bottom left corner of the 3D Preview window:



- **Front:** Activates an orthographic camera, which looks in Z-Direction.
  - **Right Mouse:** Moves the camera in X and Y.
  - **Mouse Wheel:** Zooms in and out.
  - **Middle Mouse:** Moves the camera in X and Y.
- **Left:** Activates an orthographic camera which looks in X-Direction.
  - **Right Mouse:** Moves the camera in Z and Y.
  - **Mouse Wheel:** Zooms in and out.
  - **Middle Mouse:** Moves the camera in Z and Y.
- **Top:** Activates an orthographic camera which looks in Y-Direction.
  - **Right Mouse:** Moves the camera in X and Z.
  - **Mouse Wheel:** Zooms in and out.
  - **Middle Mouse:** Moves the camera in X and Z.
- **Orbit:** Activates a perspective camera which is fixed to the selected tracking system. This enables the user to modify handles even when the camera is moving.
  - **Right Mouse:** Rotates the camera around the rig.
  - **Mouse Wheel:** Zooms in and out.
  - **Middle Mouse:** Moves the camera in rig direction or away from the rig.
- **Stop:** Disables the 3D View to improve performance on low level systems.
- **Pers:** Activates a perspective camera which is not bound to a Rig.
  - **Right Mouse:** Pans or tilts the camera.
  - **Mouse Wheel:** Zooms in and out.
  - **Middle Mouse:** Moves the camera in X and Z direction.

### 6.6.4 HUD

Activates the head up display, which displays the tracked raw coordinates of the selected rig.

▼ rig2			
Name	Offset	Tracked	Final
lensex	0,00	0,00	0,00
▼ rig1			
Name	Offset	Tracked	Final
Tilt	8,00	0,00	8,00
Pan	143,00	0,00	143,00
Roll	0,00	0,00	0,00
PosX	44,00	0,00	44,00
PosY	55,00	0,00	55,00
PosZ	66,00	0,00	66,00
Zoom	0,00	0,00	0,00
Focus	0,00	0,00	0,00
CenterX	0,00	0,00	0,00
CenterY	0,00	0,00	0,00
FrontLens	0,00	0,00	0,00
HeightLen	0,00	0,00	0,00
RightLens	0,00	0,00	0,00
Position			
X	44,0	Y	55,0
Z	66,0	Pan	143,00
		Tilt	8,00
		Roll	0,00
		Zoom	0,00
		Focus	0,00

## 6.6.5 Cyclotron Editor

The CYC Editor enables creation of *Cyc* and *CoCyc masks* which are needed to mask out regions of the Studio not covered by the green/blue screen. The *CoCyc mask* is a geometry which is created in the CYC Editor and stored on the Tracking Hub. From there the CoCyc is sent to all connected Engines. Every change in the editor and its sub elements is immediately communicated to the Engines and to the Tracking Hub.

A new Cyclotron Editor (Cyc Editor) was introduced in version 1.2. Many customers were used to the old VizIO Cyc editor and were satisfied with the functionality. This feature is back in Studio Manager, and at the moment, the two Cyc definition methods coexist together.

**Note:** The cyc data is sent to Viz Engine only when at least one camera service exists. In case of NDI, at least one camera service must exist for every Viz Engine.

## Workflows

A new Cyc workflow was introduced in Viz Engine version 4.0. The Cyc resides now in a special scene property, which resides in the Virtual Studio scene. Please refer to the [Viz Engine Administrator Guide](#) for further information. As the transportation of the Cyc information sent to the Engines is different now, there is a new dropdown in the Cyc Editor to select the used Viz Engine version.

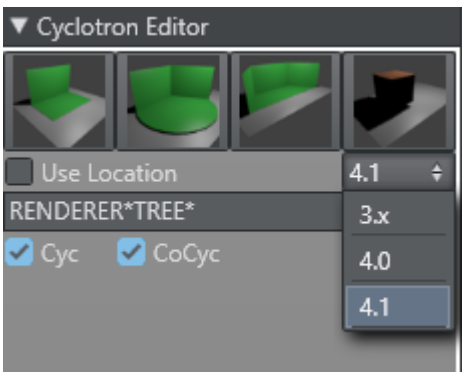

Please remember, that the Engine needs to be On Air to make the sent commands work.

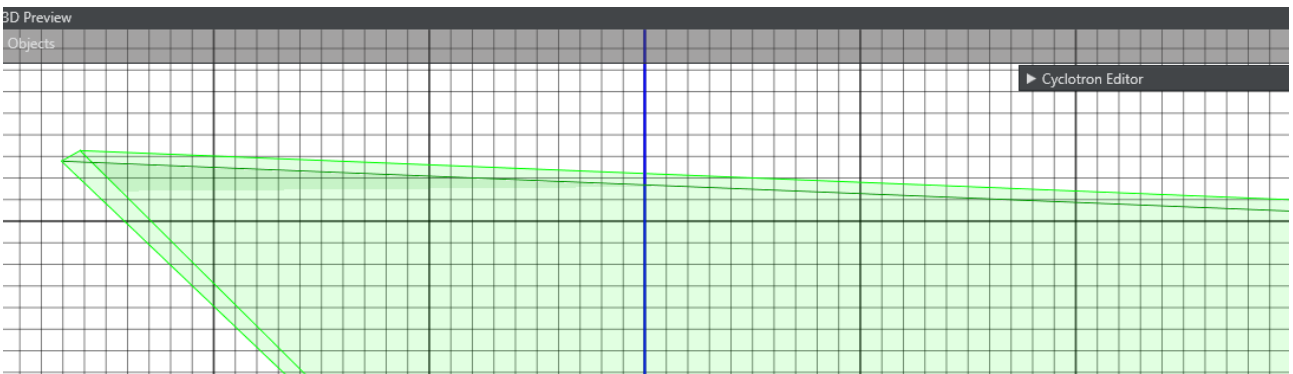

The new Cyc Editor is located in the top-right corner of the preview panel. It can be expanded by clicking the arrow on the left side.



There are three Cyclotron types are available: Back-Wall, One-Corner and Two-Corner Cyc.

## Common Cyc-Editor Elements

Position X	Position Y	Position Z
61,64	0,00	-30,68
Extra Width	Extra Height	Rotation
100,00	100,00	24,32

For every Cyc model, six common parameters can be defined. The position, rotation (Y-Axis), Extra Height and Extra Width. Extra height defines the distance from the top of the Cyc wall to the ceiling of the room. Extra width defines room size around the green wall and floor area.

## Back-Wall

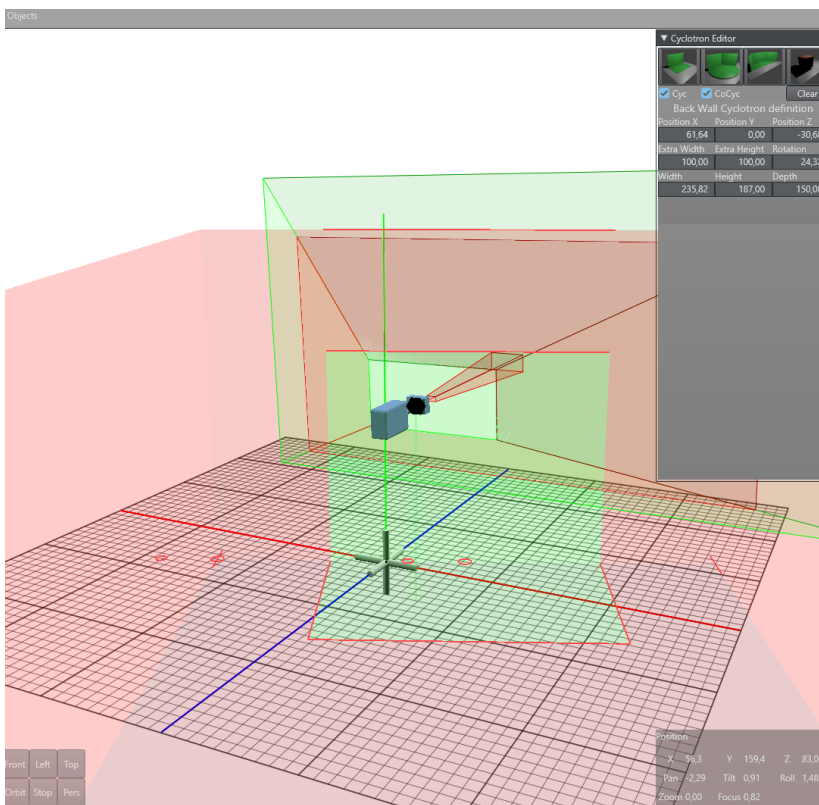

The back-wall Cyc has three additional parameters: These are the width of the green wall, height of the green wall and the depth of the ground area.

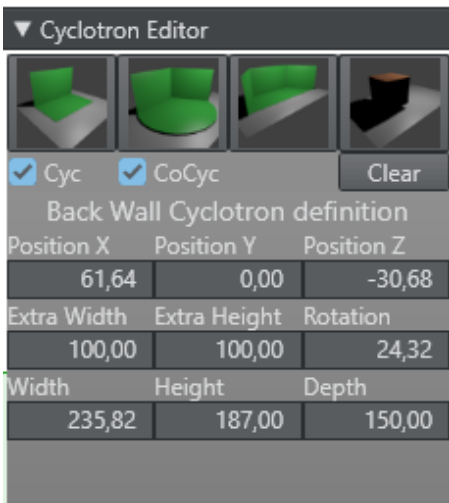

## One Corner

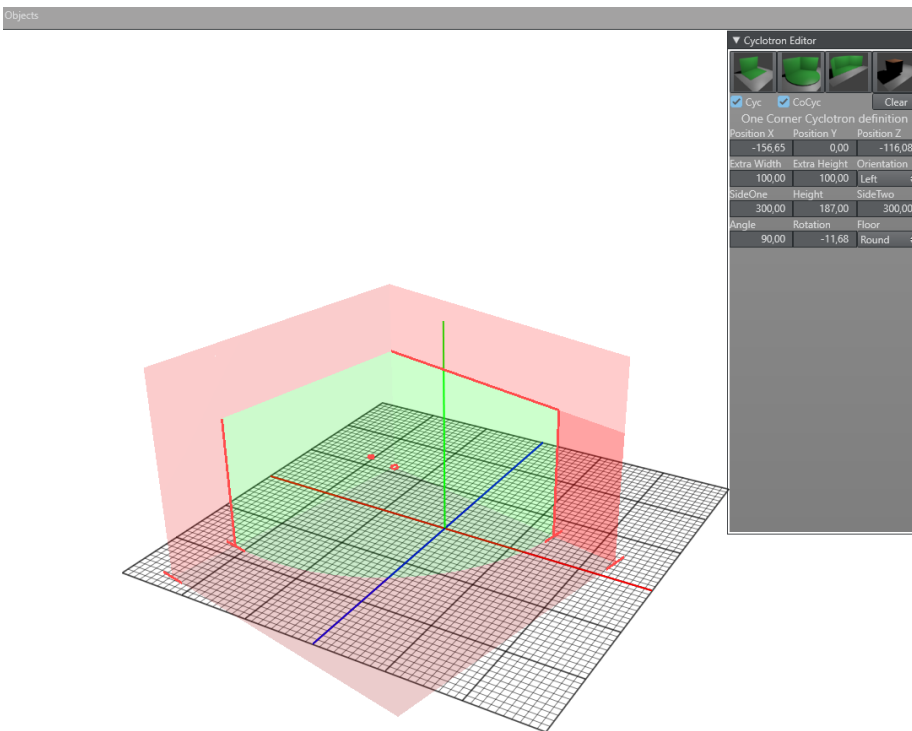

The One Corner Cyc is defined by two sides (side one and side two) and an opening angle. Additionally, the shape of the ground plane can be selected. The user can choose Round, Straight and Rectangular form.



## Two Corner

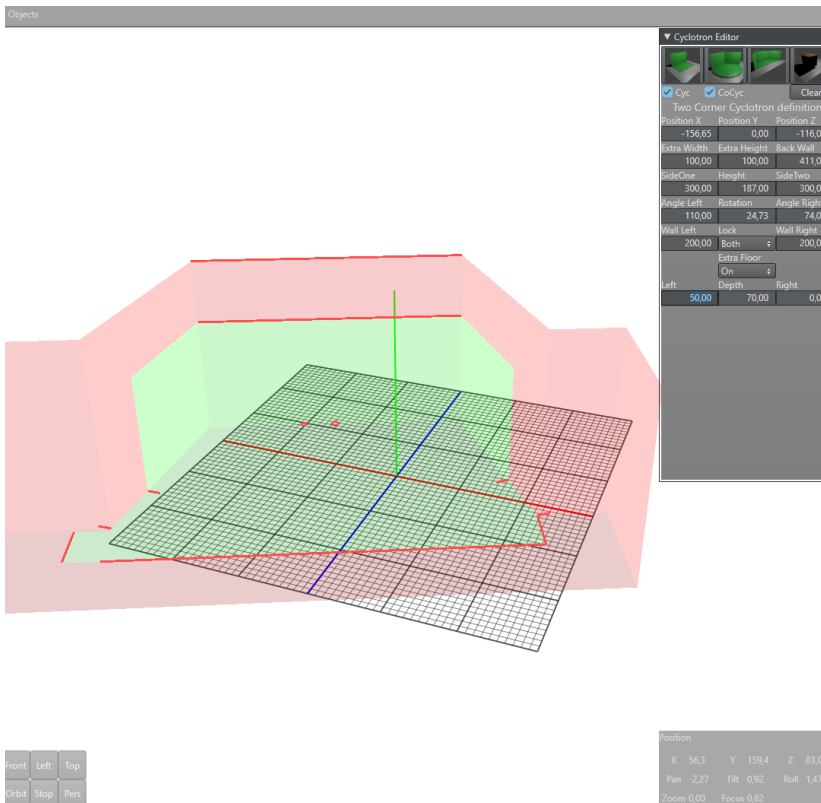

The Two Corner Cyc is defined by the length of SideOne and SideTwo, two opening angles (AngleLeft and AngleRight). It is possible to define the green area of the sides shorter than the side itself. This can be done with the parameters Wall Left and Wall Right. It is also possible to define an extra floor area. This extra floor is added in front of the green walls and extends the shape of the floor.



## Masks

For any CYC model, any amount of Masks can be added. Masks are elements which will be added to the CoCyc walls. For any mask element the position, scale and rotation can be defined in the Cyc Editor. It is also possible to select for every sides of the cube if it should be rendered or not. In the tracking hub, the amount of masks is not limited.



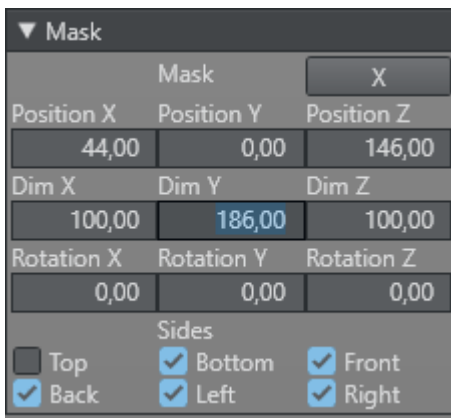
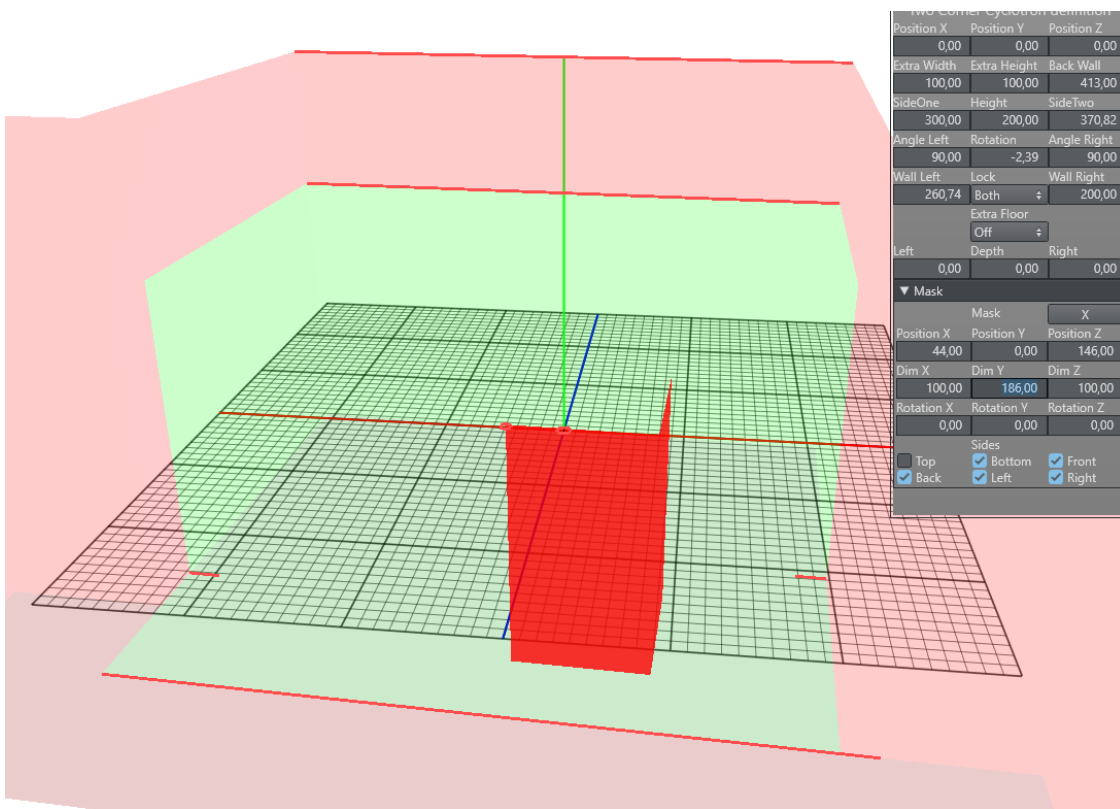

The second option to define a Cyc/CoCyc is described below. Important to know is, that as soon as the user selects the old method, the new definition is deleted and vice versa.

In Tracking Hub and the Studio Manager, a Cyc is defined by basic shapes, such as rectangles and circles, which can be added to a Shape List. All the shapes in the list are united by a Boolean operation which results in a segment list. The segment list is displayed in the segment area. From all these segments, a continuous subgroup can be selected in the editor to define if the segment is part of the green/blue wall or not. Every segment not selected (blue) is part of the floor. Every segment which is selected (green) is part of the Cyc wall. Based on this information, the Studio Manager is able to calculate a mask object which is then sent to Viz Engine.

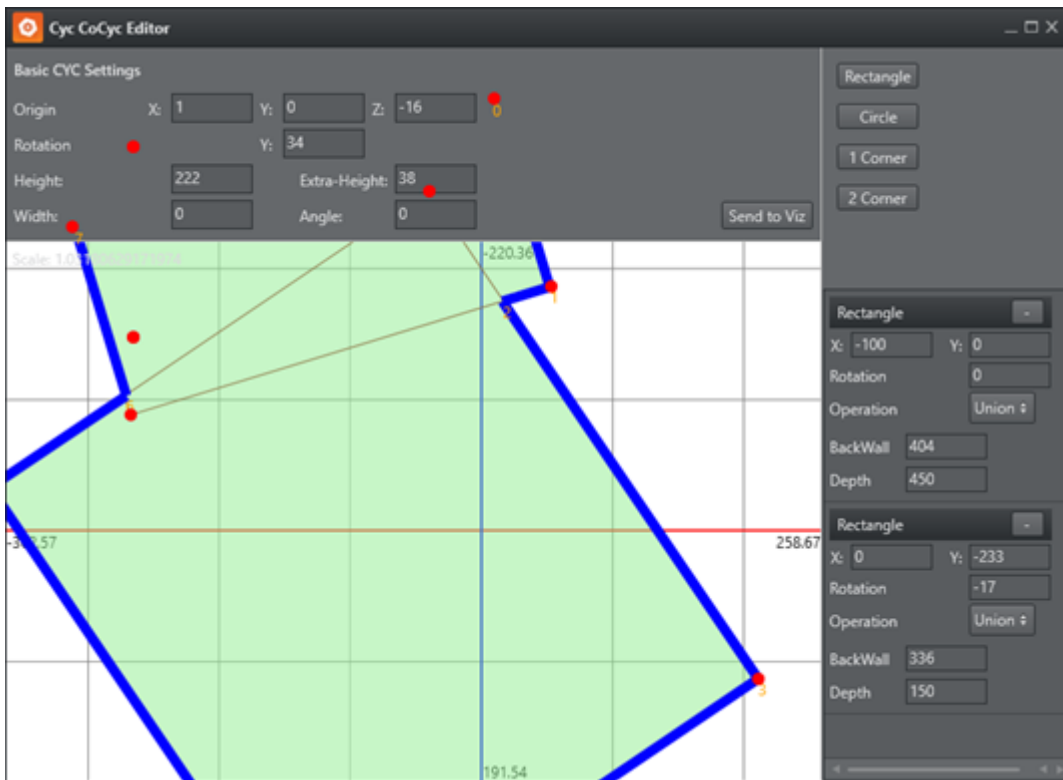

The Cyc Editor consists of the following Areas

- **Origin:** Defines the X,Y,Z offset of the generated cyc with respect to the origin of the Viz Engine coordinate system.
- **Rotation:** Defines the X,Y,Z rotation offset of the generated cyc with respect to the Viz Engine coordinate system.
- **Height:** Defines the height of the green wall.
- **Extra Height:** Defines the height of the studio ceiling.
- **Angle:** See next section.
- **Width:** See next section.

### 6.6.6 CyC Editor Angle and Width

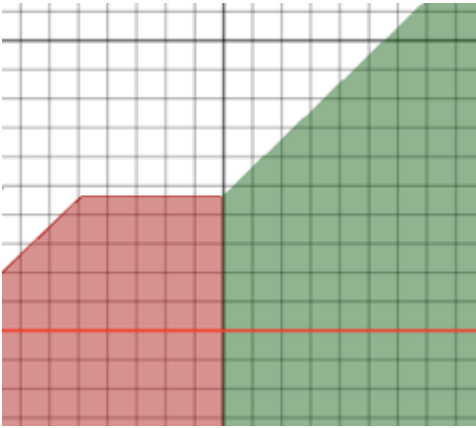

The CYC generation algorithm works as follows:

1. Find a continuous group of wall segments and mark the start and end segment.
2. Calculate the normal of the last segment which is not part of the wall group.
3. Calculate the direction of the first segment, which is a wall.
4. Extrude the CoCyc for Width cm in the calculated normal direction.
5. Continue the extrude in direction of the first wall segment plus Angle.
6. Do the same with the end segment of the continuous group.
7. Close the CoCyc with a big surrounding circular object.

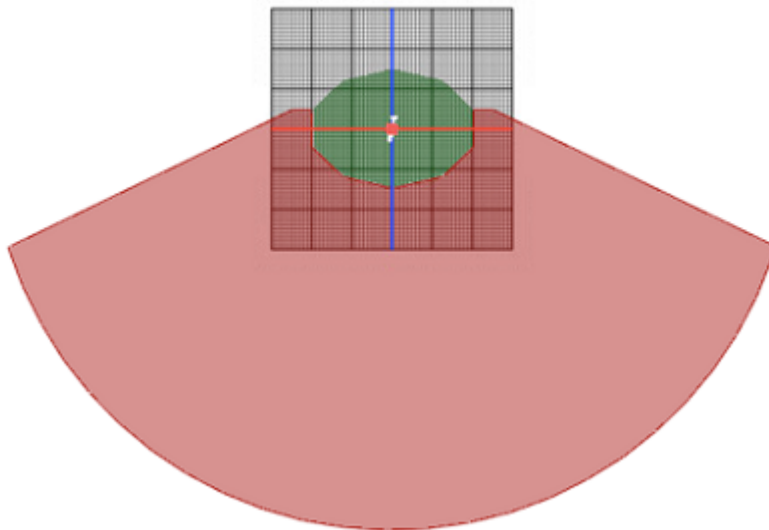

## 6.6.7 Examples

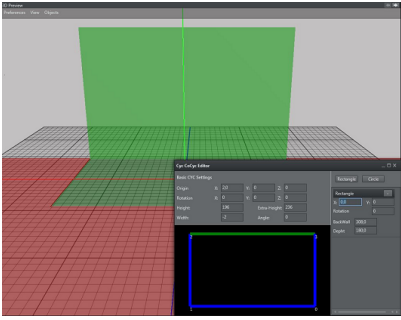
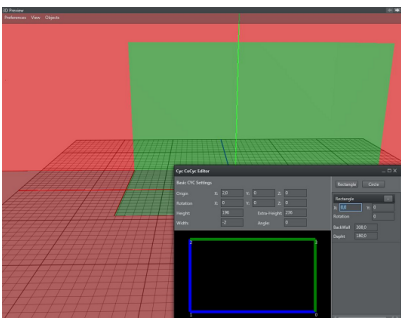
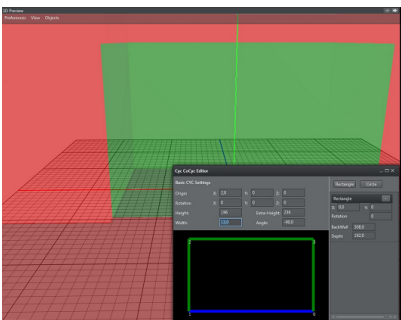
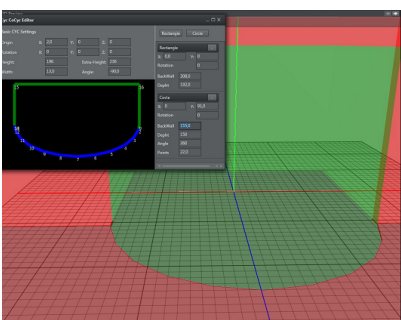
Example	Description
	<p>A simple back wall studio with one green wall.</p>
	<p>A corner studio with rectangular floor.</p>
	<p>A studio with three walls and rectangular floor.</p>
	<p>A studio with circular end floor.</p>

## 6.6.8 Shape Area

In the shape area, basic shapes can be added to the shape list. Every list element shows a dash (-) in the Header line. Clicking on the dash (-) removes the shape from the list. Every shape can have its own origin and rotation about the Y axis. Additionally, every shape has its own parameters.

- **Rectangle**
  - **Back Wall:** Sets the width of the rectangle in centimeters.
  - **Depth:** Sets the depth of the rectangle in centimeters.
- **Circle**
  - **Back Wall:** Sets the width of the circle in centimeters.
  - **Depth:** Sets the depth of the circle in centimeters.
  - **Angle:** Defines the angle of the pie the shape creates, if smaller than 360.
  - **Points:** Sets the amount of segments the shape consists of.

## 6.6.9 Cvc

Defines what parts of the Cvc the preview panel renders. The selectable elements are Wall and Floor. All these settings are stored for local use in the user settings folder.

## 6.6.10 CoCvc

Defines what parts of the CoCvc the preview panel renders.

## 6.6.11 Objects Menu

Every rig present in Tracking Hub has its own display menu with it. These options are handled in the Object menu item. In the first release, Tracking Hub offered only one Rig: Simple Camera. In future releases, more rigs will be added to allow creating Cranes and other geometries.

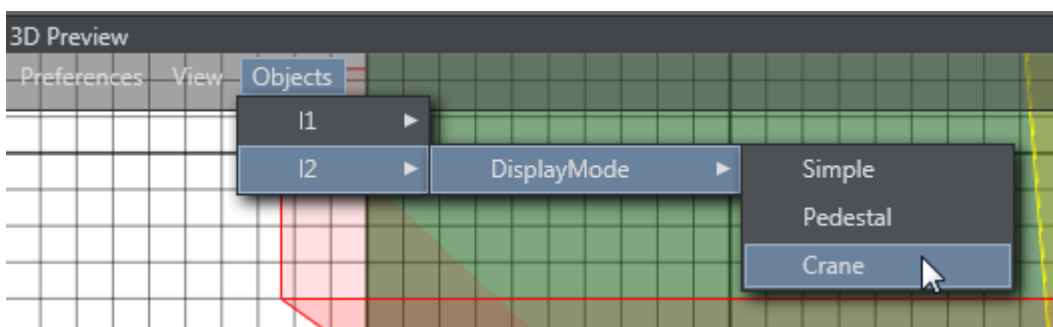

- **I1 / I2 / I3:** Selects which Rig to use.

## 6.6.12 Selectable Display Modes

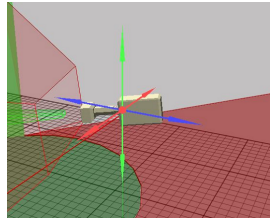
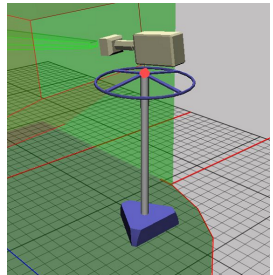
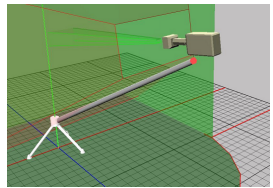
Mode	Description	Example
Simple	<p>The tracked point is displayed as selectable circle in the view.</p> <p>A rendered camera shows the offset settings.</p>	
Pedestal	<p>The rig is displayed as a tracked pedestal.</p> <p>The tracking point is always on top of the pan/tilt head.</p> <p>The rendered camera shows the offsets added to the rig.</p>	
Crane	<p>The rig is displayed as small jib.</p> <p>The origin of the base is the X/Z offset of the rig.</p> <p>The tracked point is a result of offset and height.</p>	
Object	<p>Object is a tracked object which is not a camera.</p> <p>E.g. Motion Analysis objects.</p> <p>No camera is rendered and only the tracked point is displayed.</p>	

## 6.6.13 Camera Handles

Whenever the user clicks in the rig editor to adjust a specific value, the preview panel displays the values as a handle that can be dragged. Handles can be arrows (position) or disks (rotation). Whenever the user touches a Handle with the mouse, the handle goes from its base color to yellow. This indicates that only this handle is active at the moment. Clicking with the left mouse button and moving the mouse in handle or in the opposite direction modifies the handle's value.

The following list shows all available handles and the corresponding rig values.

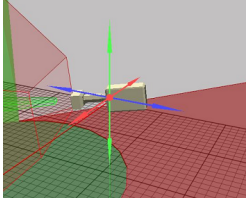
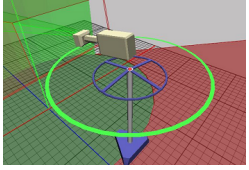
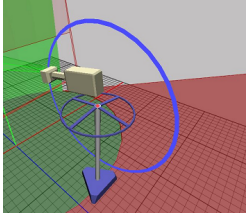
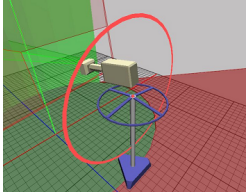
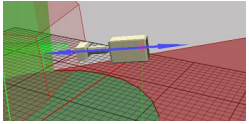
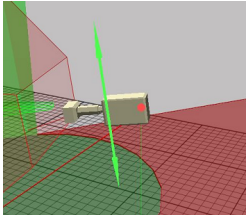
Rig Value	Description	Example
Position Offset	<p>Every axis is color coded and only visible if modifiable.</p> <ul style="list-style-type: none"> <li>• <b>Green:</b> Y Axis</li> <li>• <b>Red:</b> X Axis</li> <li>• <b>Blue:</b> Z Axis</li> </ul>	
Pan Offset	<b>Green:</b> Modifies the pan offset of the camera.	
Tilt Offset	<b>Blue:</b> Modifies the tilt offset of the camera.	
Roll Offset	<b>Red:</b> Modifies the roll of the rig.	
Front Lens Shift	<b>Blue:</b> Shows the distance from the CCD to the rotation axis of the tracking system.	
Height Lens Shift	<b>Green:</b> Displays the distance from the CCD to the tilt axis of the tracking system.	

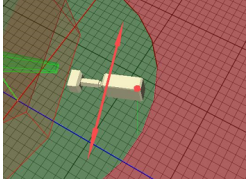
Rig Value	Description	Example
Right Lens Shift	<b>Red:</b> Displays the distance from the CCD to the rotation axis in X direction.	

### See Also

- [Configure the Studio](#)
- [Configuration Panel](#)
- [Parameter Panel](#)
- [Topology Panel](#)
- [Log Panel](#)

## 6.7 Post System

The Tracking Hub Post system lets you record tracking data and play the data back at a later time. To use this feature, every field in the video and every tracking data must be stamped with a timecode. The timecode is read by Plura timecode reader card (PCLPCIe 3G).

**⚠ Note:** While the Live timecode can be LTC based, the Post timecode must be field based (ATC VITC). If a frame based timecode is used for live, the increases the field count on every field change. This is not possible for post, as the video can be shuttled back and forward, and therefore the direction is not given for sure.



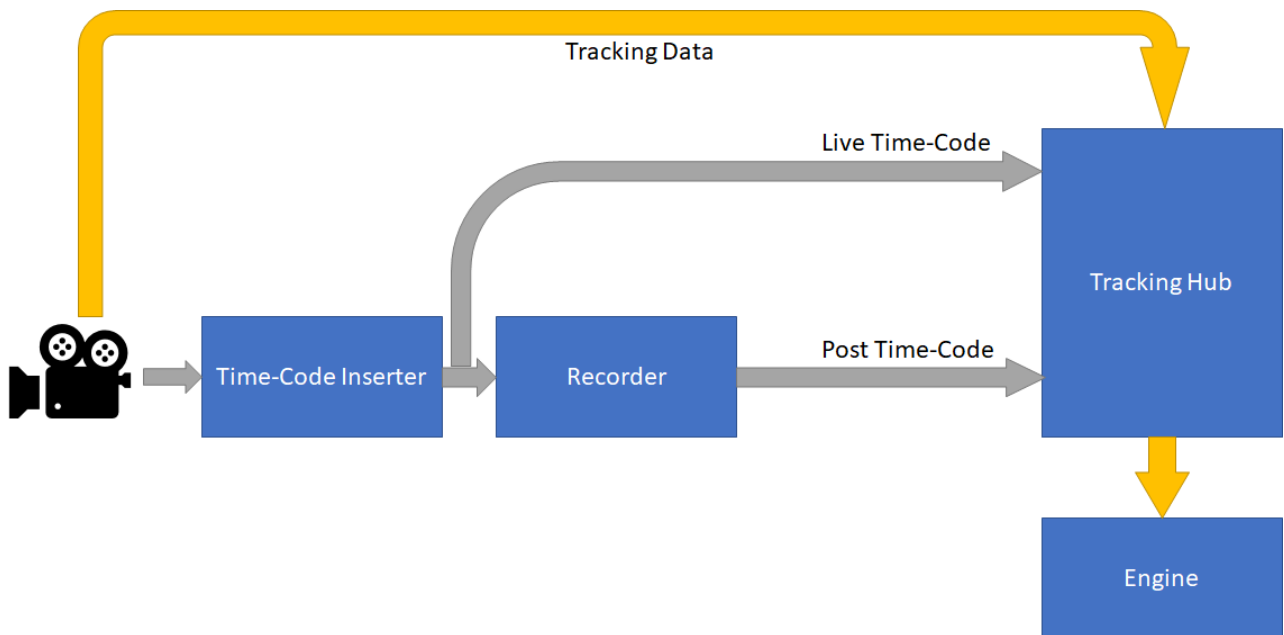

### 6.7.1 Create a Post Session

Click the **New Session** button to create a new session. Enter the session name in the pane that opens, then click **Create**.

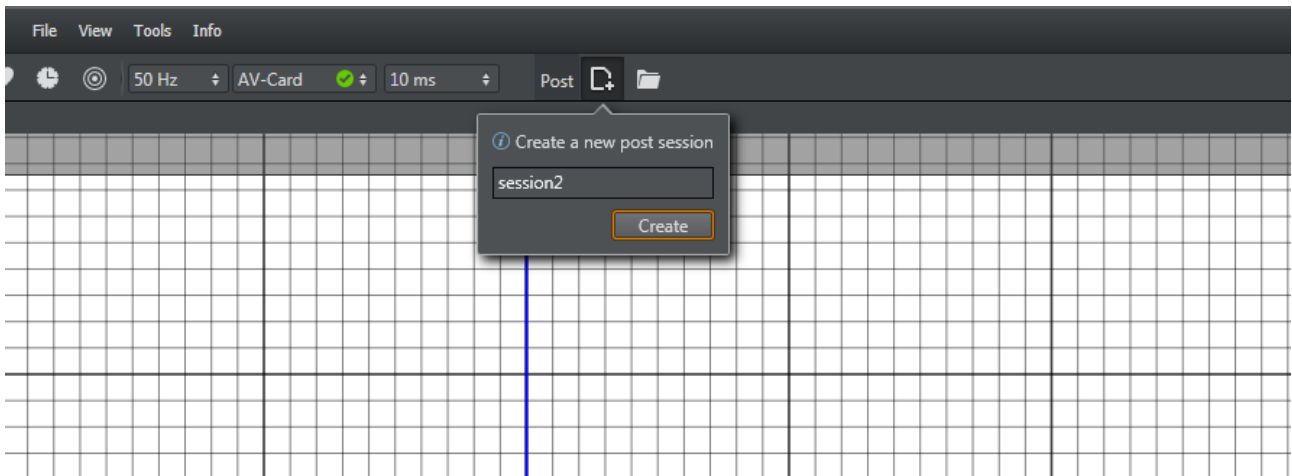

### 6.7.2 Load a Post Session

To load a previously stored session, click the **Load** button in the **Post** section of the window. A pane with a list of previously recorded sessions appears. Select one of the sessions and click **Load**.

## Session.

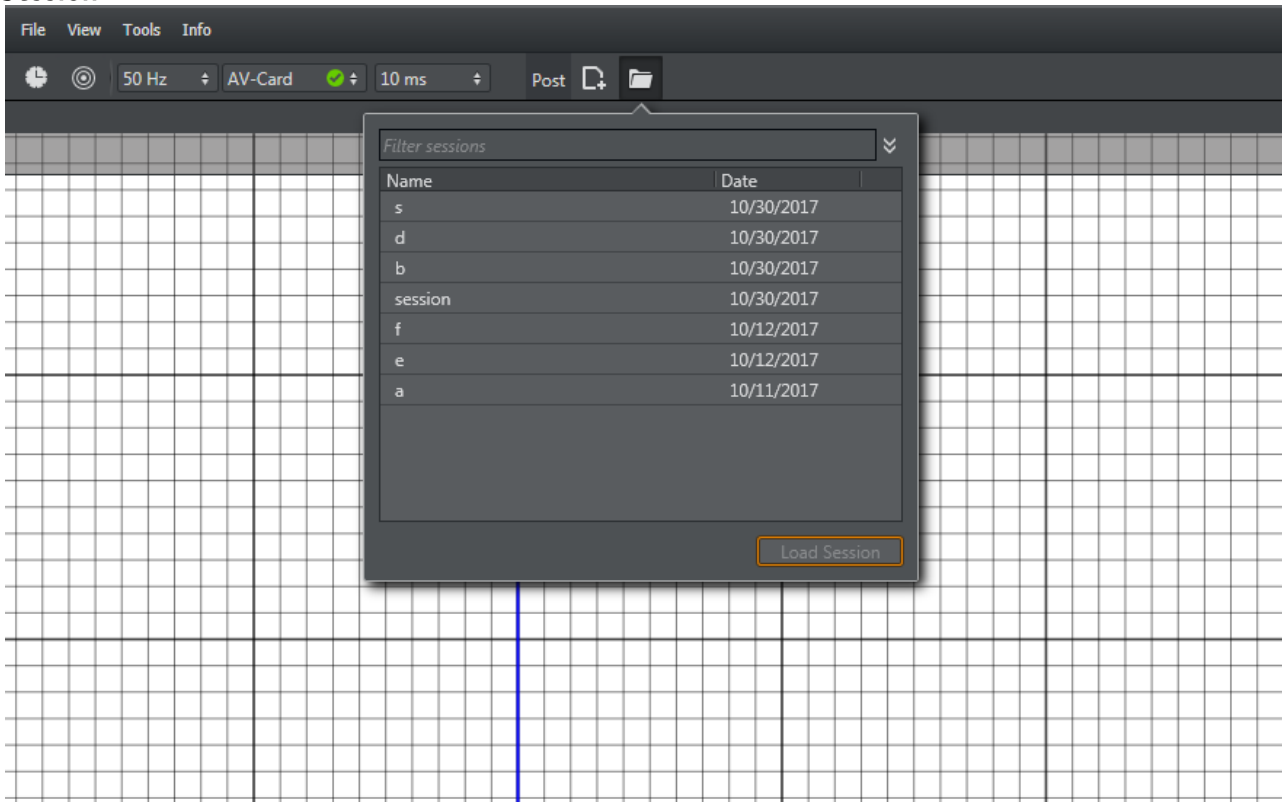

### 6.7.3 Configure a Post Session

After creating or loading a session, the timeline and timecode labels are visible. A green bar in the time line display indicates time spans where tracking data was recorded and is in memory. The red timecode arrow shows the actual post timecode. The white arrow shows the live timecode. Hold **Ctrl** and scroll the mouse wheel to modify the timeline scale. You can change the position of the timeline using the scroll bar at the bottom.

Hover the mouse over the **Post Timecode** or **Live Timecode** labels to display a tooltip that shows the Post timecode source or the Live timecode source.

You can automatically load a saved session after Tracking Hub restarts. Activate the **Auto load** switch to enable this feature.

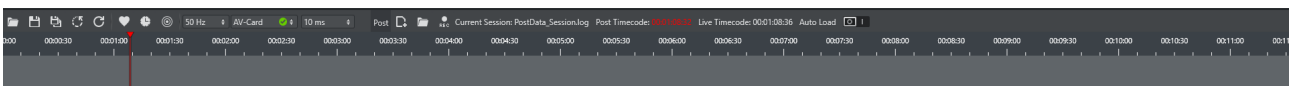

Right click the **Live** or **Post Timecode** labels to select the actual timecode source. A small window appears, which shows the available timecode sources of Tracking Hub.

**Note:** There must be run in AV-Card mode to recognize the installed Plura timecode card. Otherwise, the timecode sources are not displayed.

**SimLive** and **SimPost** are used to record tracking data without timecode reader card. This is for analysis purposes only and should never be used for production recording!

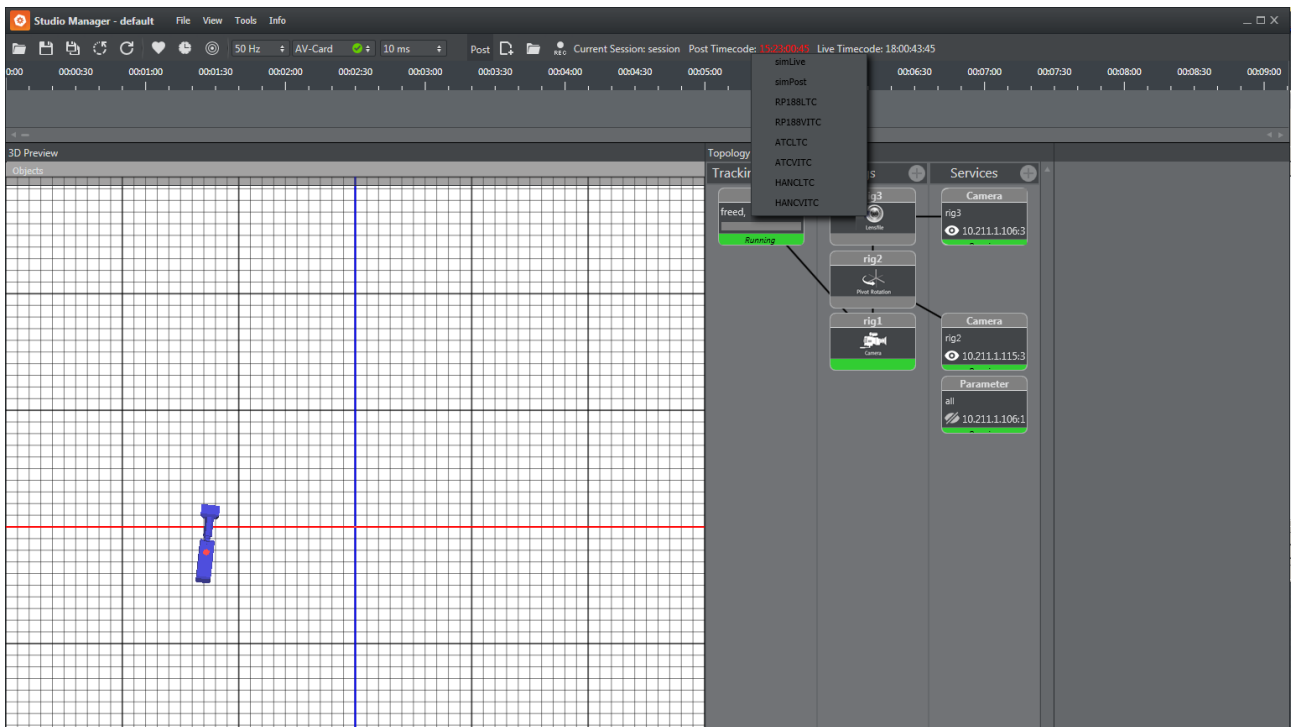

### 6.7.4 Selecting the Recording and Replay Sources

Tracking Hub can record two sources of data. The parameters coming from the tracking system can be recorded separately, and are sent to the rig during replay. This enables correcting offsets and rig setup after the data was recorded. The second source is the finally baked camera matrix, which is recorded after the rig calculations have taken place. This data can not be modified.

The following screenshot shows the parameter selection for a tracking system. For every parameter, recording and replay can be checked in a check box. An individual delay can be given for every parameter. Replay for a parameter is activated when replay is checked and the post timecode differs by more than five fields from the live timecode.

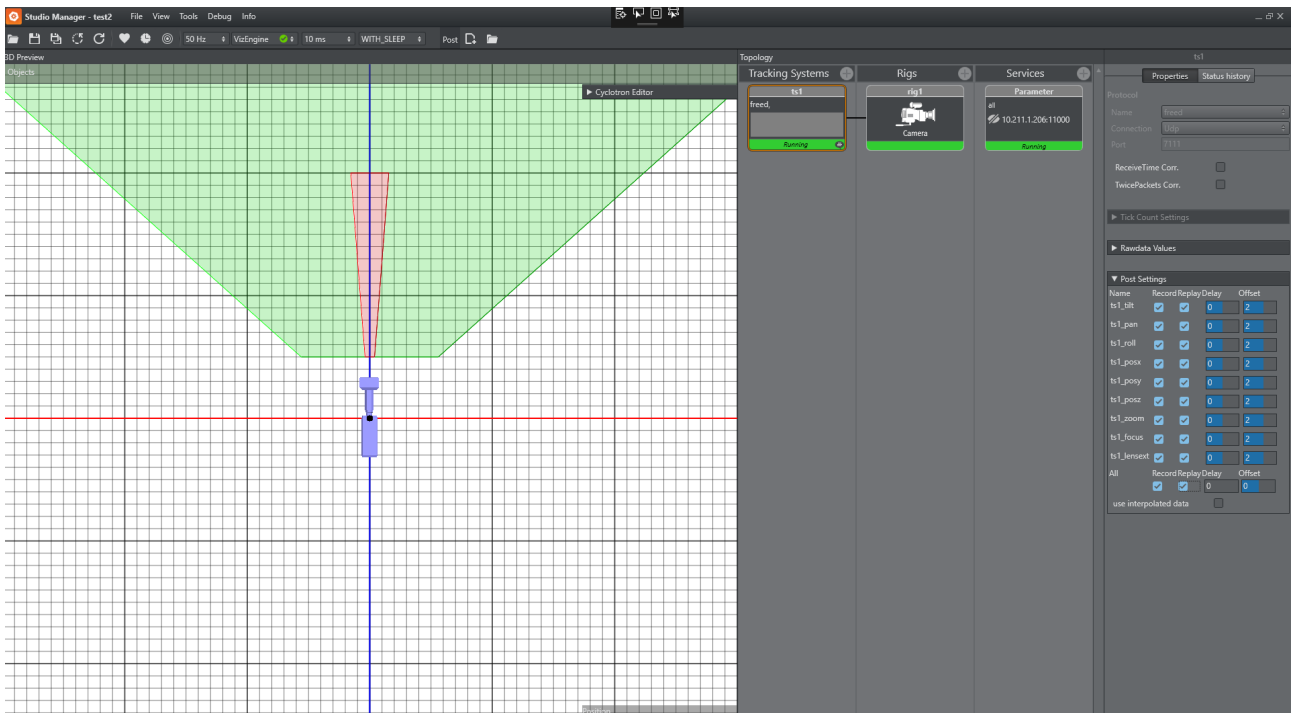

When recording tracking data, Tracking Hub records one package per field. Usually, this is the desired behavior. In rare cases (recording Motion Analysis Data), the tracking system sends more than one package per field. This can happen if a tracking system is running at 60 Hz and the studio is running at 50 Hz. In this case, Tracking Hub interpolates the data and no jitter is visible. In the recorded session, a jitter will be visible. When this happens, the flag **use interpolated data** can be switched on and the post system records the interpolated data.

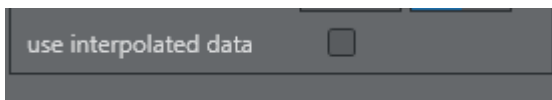

You can activate recording and replay of the camera matrix in the **Camera Service** settings. There is also an option for the camera delay.

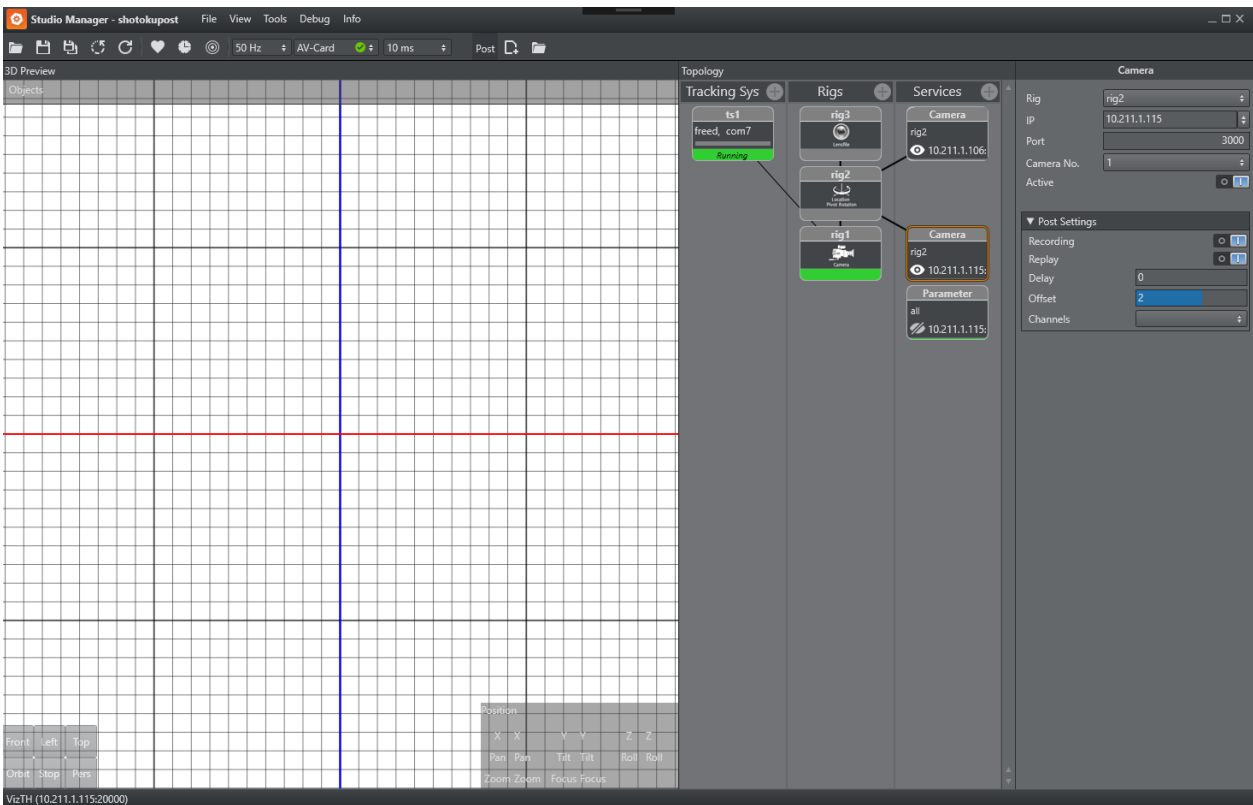

### 6.7.5 Camera Channels

When loading a session that has more than one camera, the camera channels are named by the number in creation order of the service. You can assign any channel that has been loaded from a former session to any camera service. To assign a channel to a service, choose one of the available channels from the drop down menu. If nothing is selected, the channel with the number of the camera service is used.

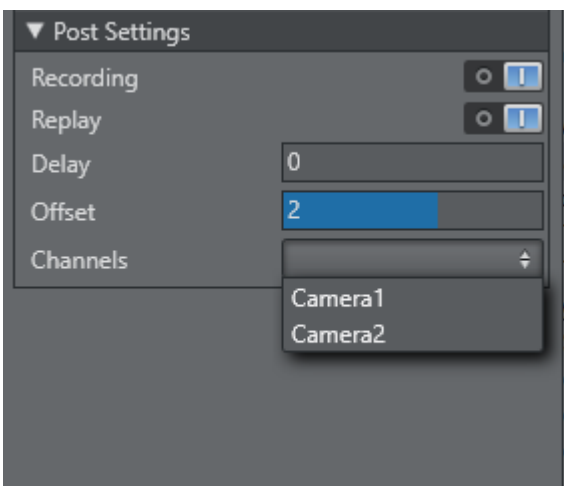

## 6.7.6 Post Offset and Delay

Tracking Hub offers two types of delays. One is an offset that is added or subtracted (depending on the sign) from the actual Post timecode. The typical offset for Parameter recording is `-2` fields, and for a camera matrix recording it is usually two fields. The second delay setting is a ring buffer. This is useful in configurations where shuttling back and forward is used.

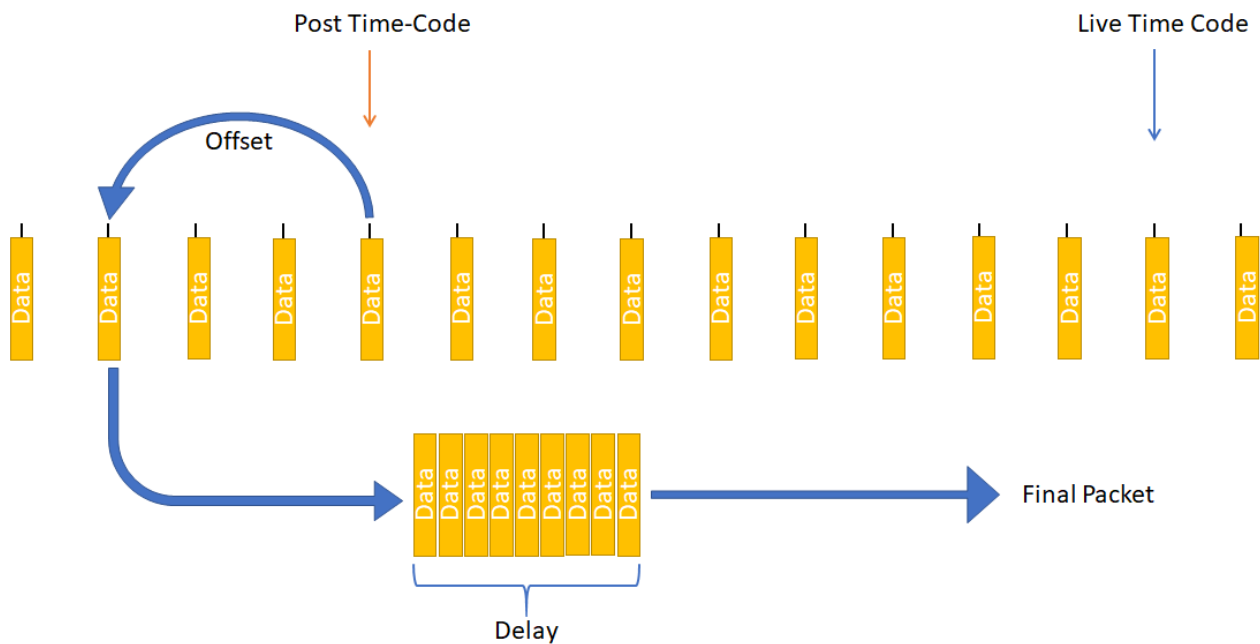

## 6.7.7 Post Data Storage

The post data is written to file immediately after being received. Tracking Hub contains about four hours of data in memory.

- The storage location is `C:\ProgramData\vizrt\VizTH\Post`.
- The ring buffer size of the post channels can be changed in the `BaseConfig.xml`.
- `PostBufferSize` is the number of packages stored before the oldest is deleted.
- `PostFileCutTime` is the time when Tracking Hub creates a new save file for the PostData. The `PostFileCutTime` gives the **Time** in minutes.

**Example:** `PostBufferSize="1000000" PostFileCutTime="0"`

## 6.8 Data Flow Inspector

The Data Flow Inspector allows the user to visually monitor the incoming and outgoing tracking data to prove its quality. Errors within the actual received and transmitted values can easily be spotted.

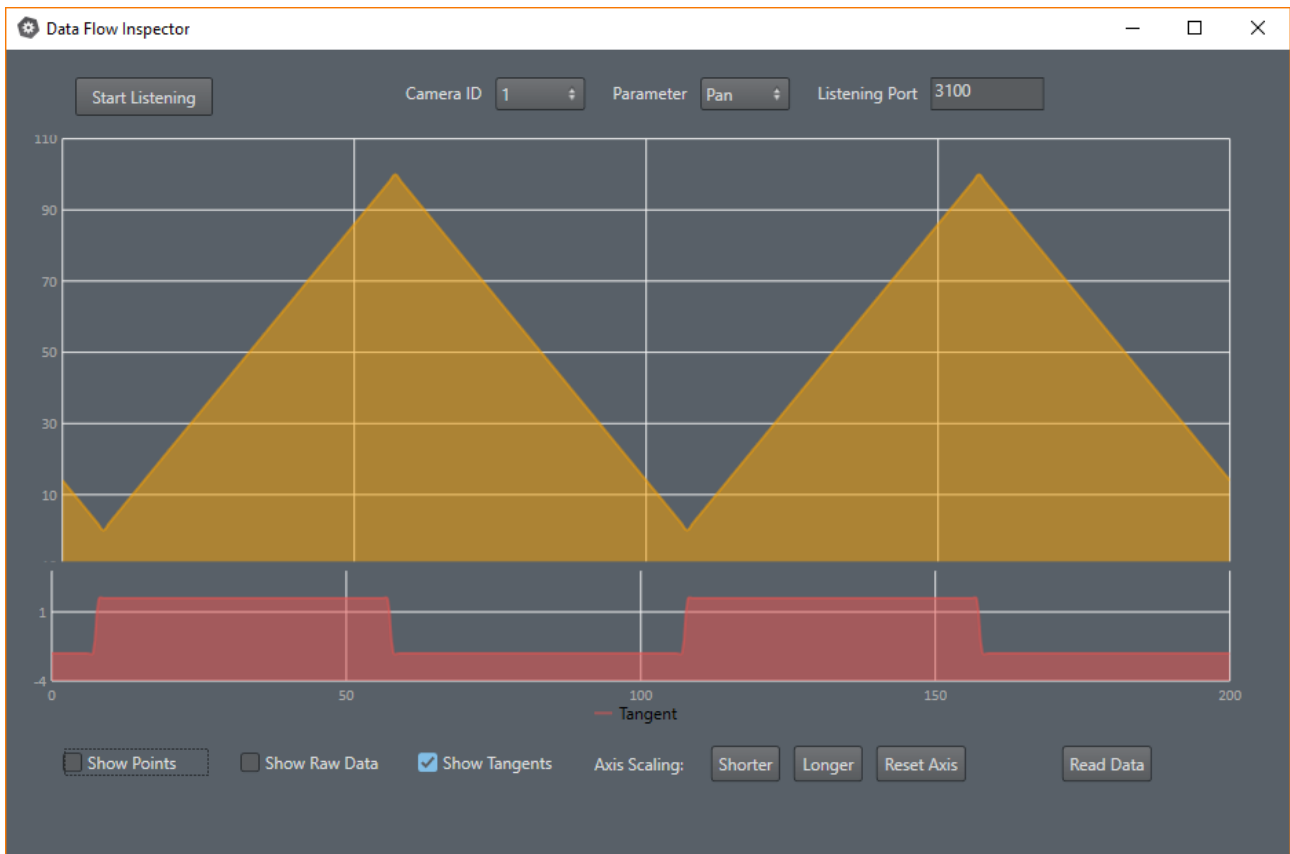

Viz Studio Manager provides two different kind of data services:

- The tracking systems raw data values monitor the genuine incoming data sent from the tracking system.
- The final outgoing tracking data sent to the Engine includes the rig transformations and all the offsets set up within Tracking Hub.

### 6.8.1 To Activate Monitoring

To be able to see the tracking data values in the Data Flow Inspector, a service must be set up which forwards the packages.

#### Raw Data

A new *tracking flow raw service* needs to be added.

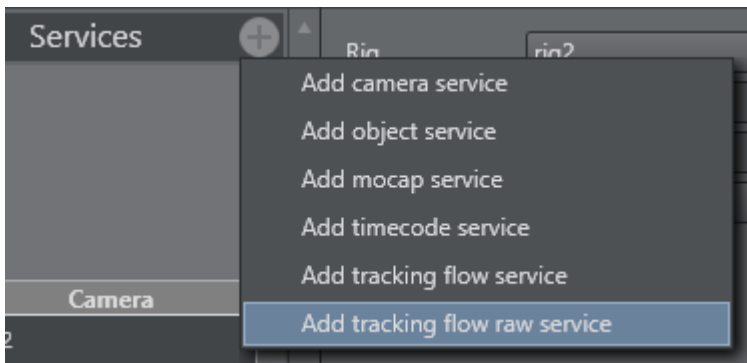

- **Trackingsystem:** Name of the tracking system node which should be monitored.
- **IP:** IP address of the machine where the data flow inspector is running (typically the local machine address).
- **Port:** Default Port is set to 3200 .
- **Active:** Turns service on or off.

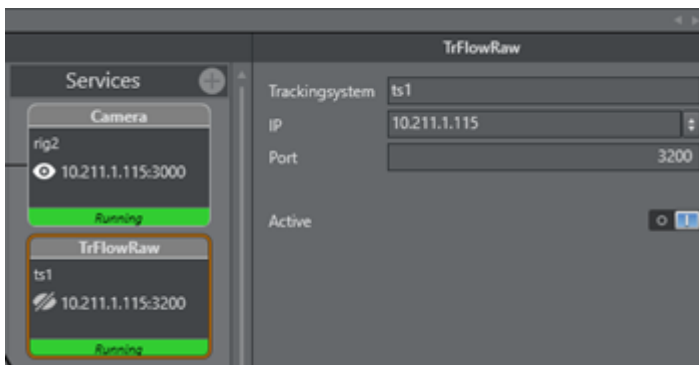

## Rig Data (Final Transformation)

A new *tracking flow service* needs to be added.

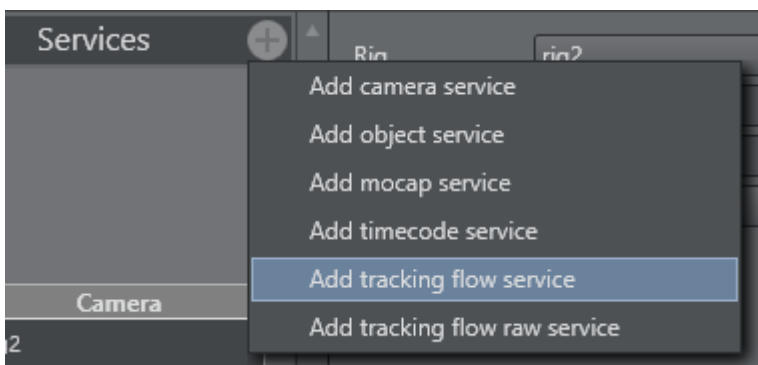

- **Rig:** Name of the rig node which should be monitored.
- **IP:** IP address of the machine where the data flow inspector is running (typically the local machine address).
- **Port:** Default Port is set to 3100 , can be changed in the Data Flow Inspector.



- **Camera No.:** Camera ID of the virtual camera.
- **Active:** Turns service on or off.

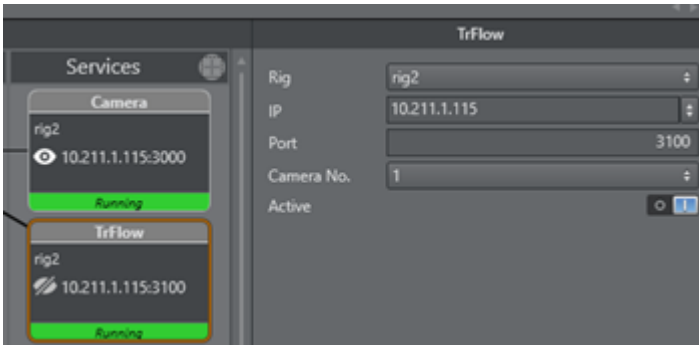

After the services are running the Data Flow Inspector can be started.

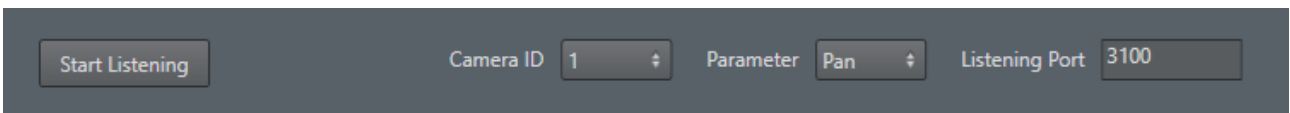

- **Start Listening:** Starts receiving incoming tracking data. As soon as data is detected, it is added to the graph.
- **Stop Listening:** Stops receiving data.
- **Camera ID:** Sets the ID for the virtual camera used for receiving data. This especially is needed when multiple data packages are send to the same recipient.
- **Parameter:** Defines which parameter of the tracking data should be prompted on the graph.

Tracking Flow Inspector supports 18 different parameters sent from Tracking Hub to Engines.

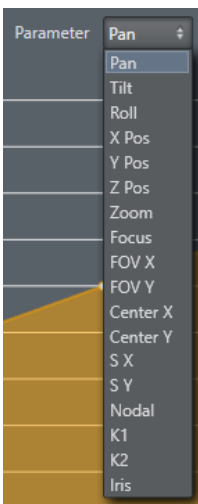

**Information:** Raw data values do not support all 18 parameters. Available options are: Pan, Tilt, Roll, PosX, PosY, PosZ, Zoom and Focus.

## Tangent Curve

The tangent curve represents the slope between every point. Strong changes within this curve indicate that the difference between points is high and therefore probably not following smooth and realistic values. This curve can be enabled/disabled on the bottom menu.

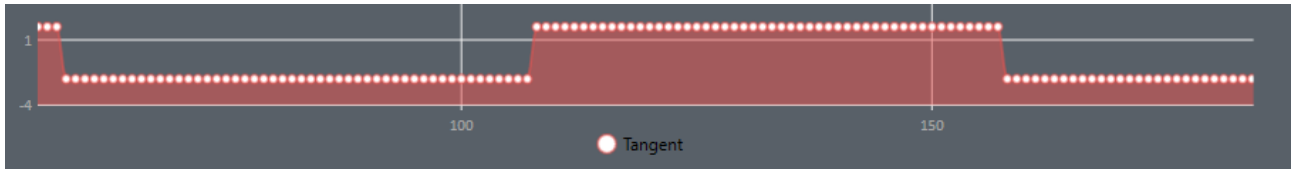

Below is an example of tracking data coming in a perfect ramp, the tangent clearly shows the change in direction of the tracking data values.

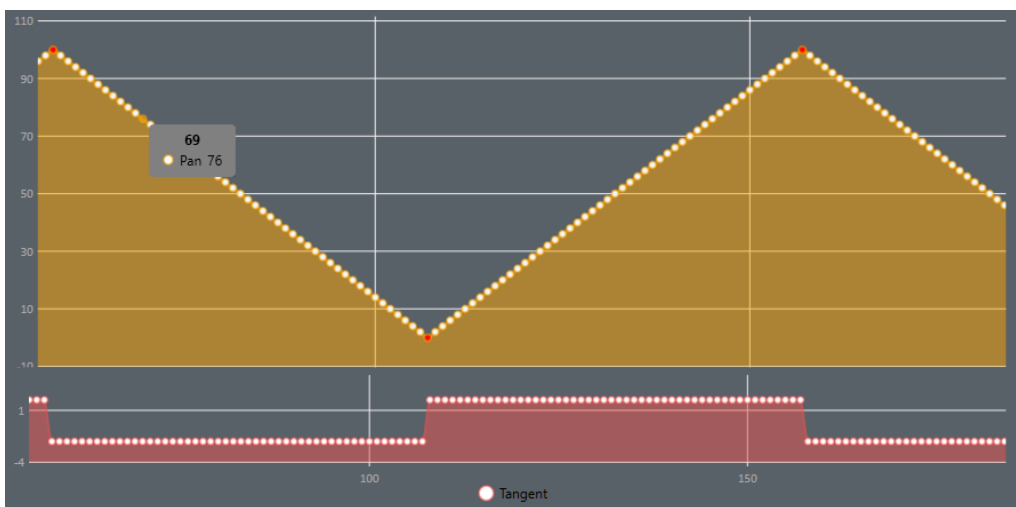

## Axis Scaling

The scaling of the axis can be changed to give a better overview of the currently represented data. The button menu at the bottom defines the amount of data packets recorded by the graph at a time.

By default, 200 packets (data values) are represented in the graph.

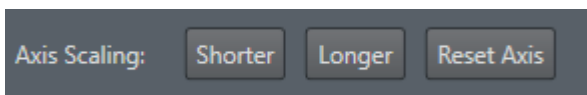

- **Shorter:** Decreases axis scaling range.
- **Longer:** Increases axis scaling range.
- **Reset Axis:** Resets the axis scaling range to default (200 packets).

## Zooming

The mouse wheel can be used to zoom in or out of the graph to get a closer look at the values between the points.

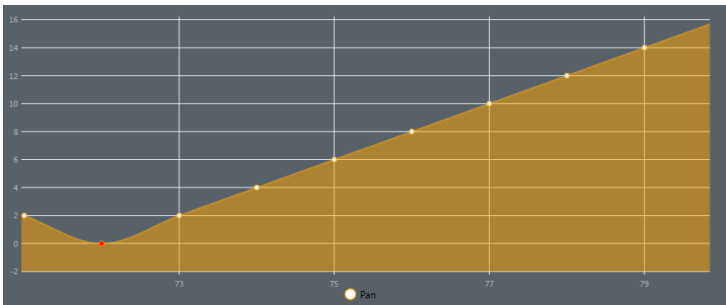

- **Show Raw Data:** Switches to show the raw data. A raw data service has to be active in Studio Manager.
- **Show Points:** Draws the points onto the graph for reading the precise value. Having too many points drawn (longer axis range) results in slowing down the graph.

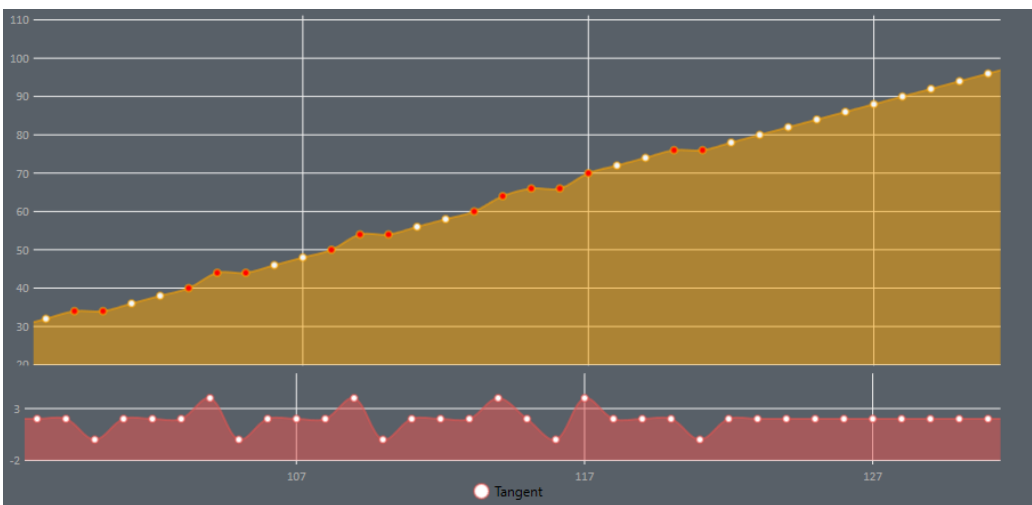

Red Points do indicate possible errors in the data. This means that the average difference between two following points is probably too high.

**Warning:** Red points are intended as a help and do not show definite errors. While a strong change in direction between points is highly unlikely, it is no guarantee that the packet is actually wrong.

---

## 7 Studio Manager Configuration

This section details how to configure the Studio Manager. Make sure to configure the Studio first, then the Topology.

This section contains the following topics:

- [Configure the Studio](#)
- [Configure Topology](#)
- [Tracked Cameras and Viz Engine](#)
- [Router Control](#)
- [Backup Configuration](#)
- [Use of Templates](#)
- [Replay Tool](#)
- [Post Data Inspector](#)
- [NDI Service](#)
- [Embedded NDI Tracking Data](#)

---

### 7.1 Configure The Studio

This section details how to configure Viz Virtual Studio.

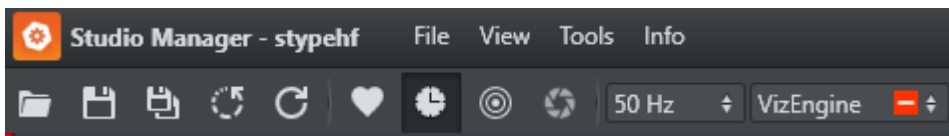

1. Click **Open** to select a previously saved studio configuration, or create a new configuration by clicking **Save As**.
2. Set the **Frequency** frame rate. Available options are:
  - 50 Hz
  - 60 Hz
  - 59.94 Hz
  - 30 Hz
  - 29.97 Hz
  - 25 Hz
  - 24 Hz
3. Set the **Synchronization** base:
  - **Freerun**: Does not synchronize. Tracking Hub runs using its own time base, corresponding with the configured frequency. This option should not be used in production environments.
  - **AV-Card**: Synchronizes using Plura PCL-PCI or PCL-PCIe sync cards.
  - **Viz Engine**: Synchronizes with a Viz Engine running on the same computer.
4. Go to [Configure Topology](#).

## 7.2 Configure Topology

This section details Topology configuration, which includes Tracking Systems, Rigs and Services.

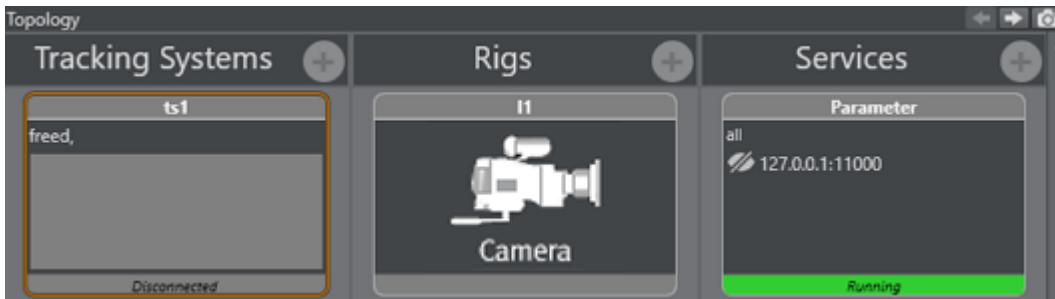

At any time, view the properties of each configuration in the [Configuration Panel](#).

The Topology configuration should be done in this order:

- Configure a Tracking System.
- Configure a Rig.
- Configure a Service.

### 7.2.1 Configure a Tracking System

To Add and Configure a Tracking System

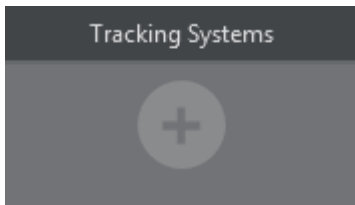

1. Click .
2. Type a **Name** for the configuration.
3. Select which protocol to use to receive data from the tracking system:

**Note:** If changing the protocol of an already configured tracking system, the default configuration parameters for the new protocol are read by the system.

4. Select a connection type. Depending on the tracking system select the connection type:
  - **Serial:** If serial is selected, also select a **Comport** (in the **Comport** box, all available comports are shown). If the default baud rate is not used, enter the correct one in the **baudrate** field. Also set the parity, stop bits and data bits according to the values provided by the manufacturer.

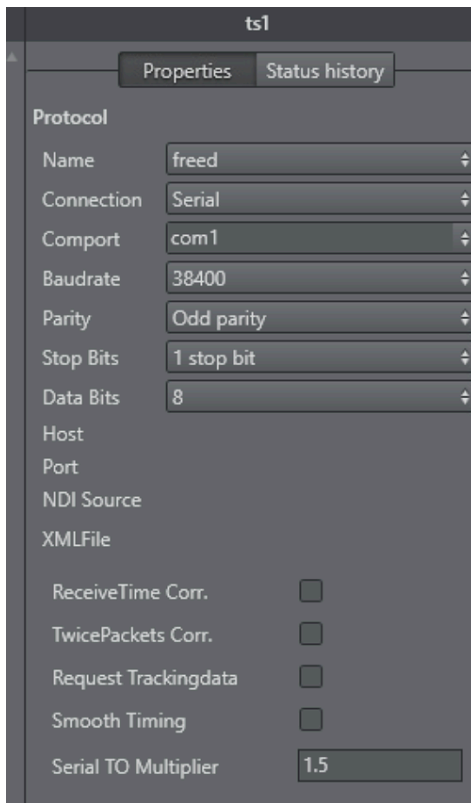

The *Serial Timeout Multiplier* should only be changed in values between 1.1 and 2.0 and needs to be adjusted only when receive problems occur.

- **TCP/IP:** Type in the **Host** IP to use (it is possible to enter the port number as well).
- **UDP:** Type in a **Port** number to use.
- **NDI:** please see: [Embedded NDI Tracking Data](#)

#### 5. Options available for all tracking systems:

- **ReceiveTime Corr:** Ignores the receive time of the package and sets it to the last sync time. This makes the interpolation smoother, assuming that the tracking data sample rate is stable. Sometimes the tracking data transport can be unstable, for example, when serial data is converted to fiber and back to serial. In this case, the tracking packages are coming irregularly.
- **TwicePackets Corr:** Shifts double packets to the correct receive time. As a special case of the *ReceiveTime Corr.*, it can also happen that two tracking packets arrive at the same time. This is often the case when old USB converters are used.
- **Request Trackingdata:** Forces Tracking Hub to send the trigger to the tracking system. There are still some old tracking systems in the field which demand a trigger to send the data to Tracking Hub. Such systems are Thoma or old Vinten heads.
- **Smooth Timing:** Forces Tracking Hub to distribute the receive time of all received packages evenly. Use when *Receive Time Corr.* and *TwicePackets Corr.* do not have the desired effect.
- **Serial TO Multiplier:** Determines the timeout when Tracking Hub reports missing tracking data is defined by the frequency of the studio sync (for example, for PAL the timeout is 20 milliseconds). When the packets are coming irregularly, Tracking Hub

would continuously show an orange status. This timeout multiplier can improve the result by increasing this timeout interval.

- **Tick Count Settings:** Most encoder based systems do not send angles or position in centimeter to Tracking Hub. They send an encoder based tick count, which must then be converted to angles and positions. Usually, the divisor of the tick count is defined by the protocol. This default values are predefined in Tracking Hub. In rare cases it can happen that the tick count differs from the default values. When the tracker is

▼ Tick Count Settings	Error Percentage
tilt	32.761,00 0
pan	32.768,00 0
roll	32.768,00 0
posx	640,00 0
posy	640,00 0
posz	640,00 0
zoom	1,00 0
focus	1,00 0
lensex	1,00 0

disconnected this default values can be adjusted.

- **Error Percentage:** Sometimes it can happen, especially when using old tracking systems, that an encoder get damaged. This usually results in one frame short random values sent to the tracking hub. The error percentage is the limit when Tracking Hub filters out unplausible values. The filter is activated when the actual value differs more than the error percentage from the last value.

**⚠ Caution:** This is an emergency solution. If such errors occur, the tracking system must be repaired as soon as possible.

- **Rawdata Values:** The *Rawdata Values* show the actual incoming ticks per axis. It is also possible to add an offset to the tick count. This can be useful during lens calibration of when setting up a crane. This panel is only visible when the tracker is

connected.

▼ Rawdata Values		
Name	Value	Offset
ts1_tilt	0,00	0,00
ts1_pan	1.245.186,00	0,00
ts1_roll	0,00	0,00
ts1_posx	0,00	0,00
ts1_posy	0,00	0,00
ts1_posz	0,00	0,00
ts1_zoom	0,00	0,00
ts1_focus	0,00	0,00
ts1_lensex	1,00	0,00

- **Post Settings:** Please see: [Post System](#).

6. Right-click on the Tracking Systems box and select **Connect** (connect to the tracking system).

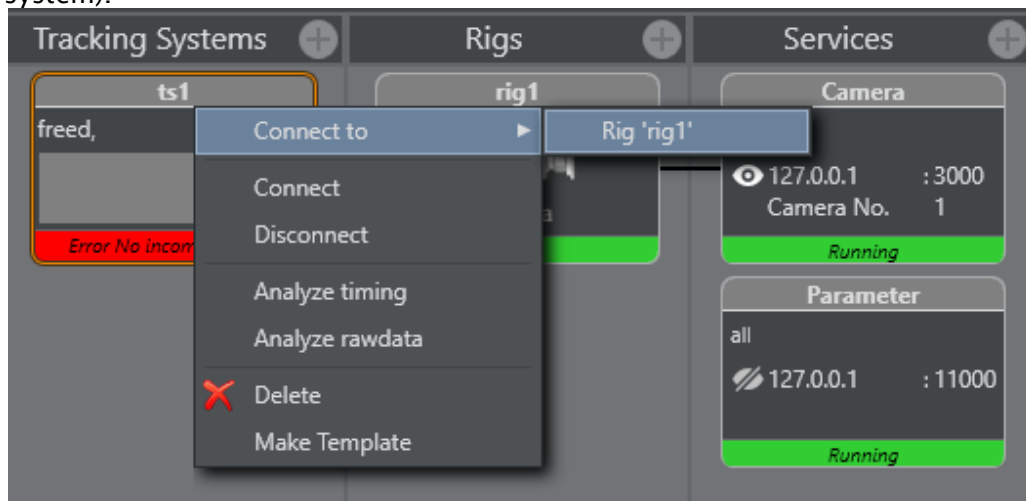

The Tracking Hub now connects to the selected Tracking System. Observe the colors on the bottom of the symbol:

- **Green:** Connection is done and data receiving in time.
- **Orange:** If the color becomes orange, after a few seconds, connection is done and data receiving, but not in time.
- **Red:** If the color becomes red, possible connection failure or data is not received.

7. Go to Configure a Rig.



## 7.2.2 Configure a Rig

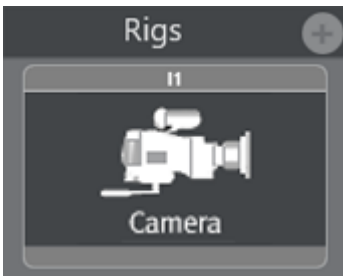

1. Click .
2. Select from the list:

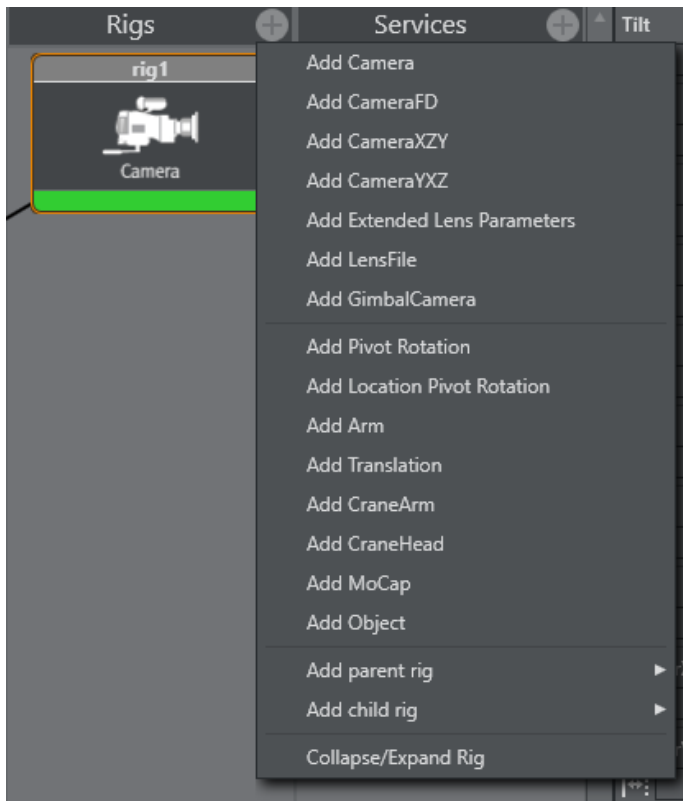

- Add simple camera:

- Right-click the Tracking System and select **Connect to > Rig (Lattice)**.

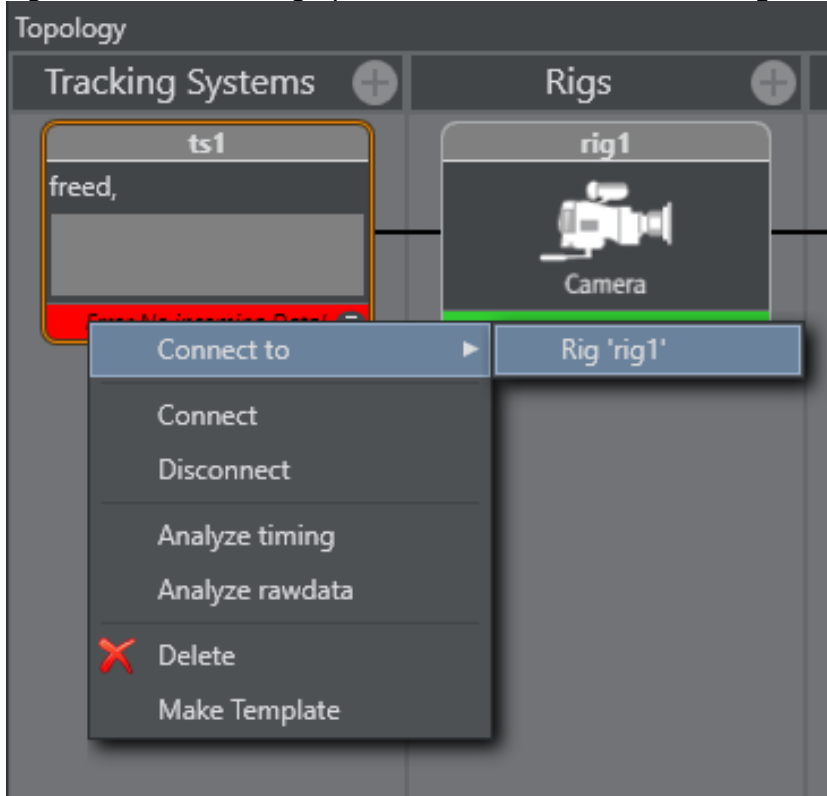

- Set or change tracking parameters as required. When finished Click **OK**.

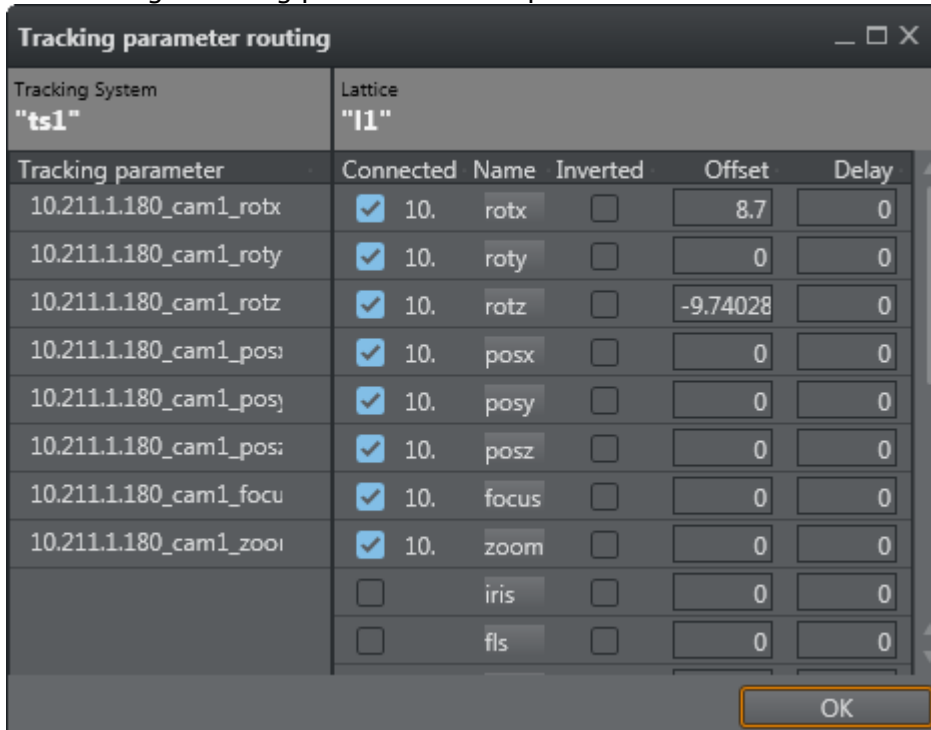

- Go to Configure a Service.

### 7.2.3 Configure a Service

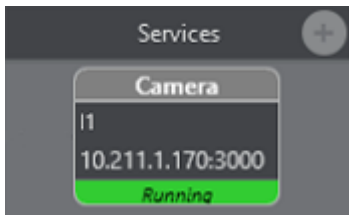

1. Click .

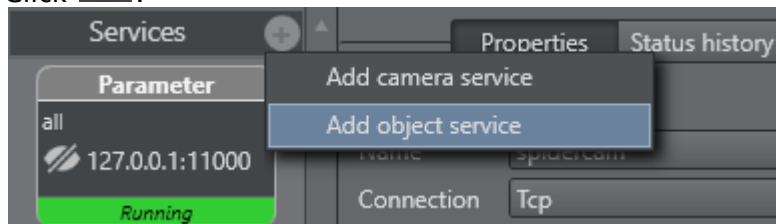

2. Select a Service:

- **Add camera service**
- **Add object service**
- Click on the service icon in the Services panel.
- Configure the service in the Properties panel. When the service is added, one rig and one camera field are available. Pressing the + button add a rig/camera combination. It is possible to send any number of rigs to one Engine.

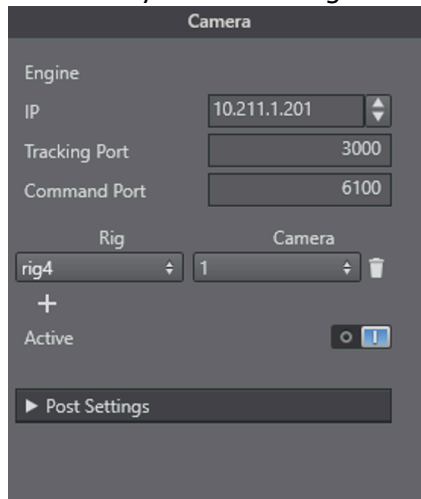

- Rig:** Type the name of the rig whose data should send to an Engine.
- IP:** IP address of the Viz Engine, which is to receive the tracking data.
- Port:** Port number for this connection (same port as configured in the Viz Engine configuration).
- Cam.Number:** Same as Viz Engine is expecting.
- Mode:** Not in use (default = 0).
- Active:** When checked the service is active, unchecked no data is sent to the Viz Engine.

- Click **Start** in the [Configure the Studio](#).
- Click **Save** in the [Configure the Studio](#).

## 7.2.4 Set a Delay

To match tracking data with the Engine rendering, set a delay (in fields). The delay can be set in fractions of fields and individual for every parameter.

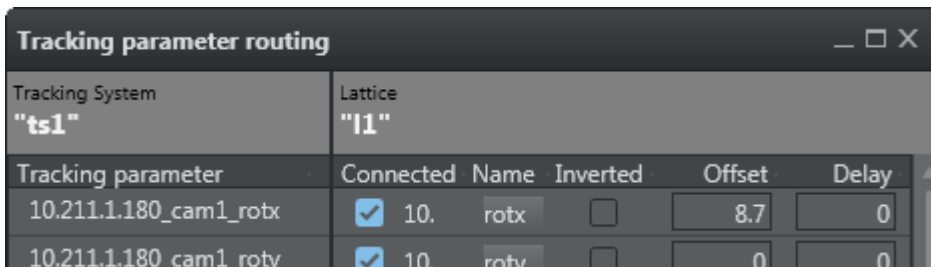

Tracking System	Lattice				
"ts1"	"11"				
Tracking parameter	Connected	Name	Inverted	Offset	Delay
10.211.1.180_cam1_rotx	<input checked="" type="checkbox"/>	10. rotx	<input type="checkbox"/>	8.7	0
10.211.1.180_cam1_roty	<input checked="" type="checkbox"/>	10. roty	<input type="checkbox"/>	0	0

A delay can be set for each parameter individually or overall for the whole camera rig node. The parameter delay is added to the the overall delay.



Overall Delay (Fields)

Interpolation

Use LeastSquare

## 7.2.5 Set an Offset

An offset (cm) can be added to a tracking parameter value, when passed to a rig, to correct positional rotation of a camera and, or an object

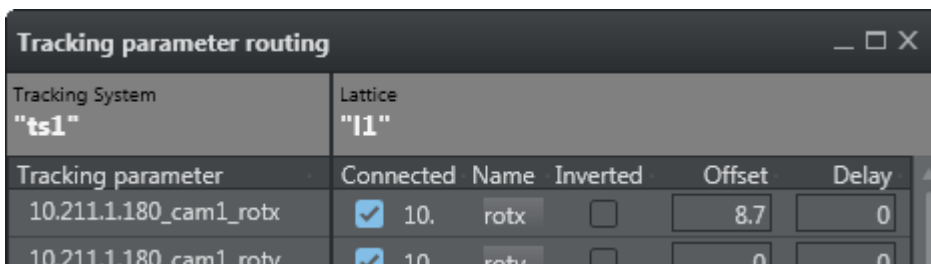

Tracking System	Lattice				
"ts1"	"11"				
Tracking parameter	Connected	Name	Inverted	Offset	Delay
10.211.1.180_cam1_rotx	<input checked="" type="checkbox"/>	10. rotx	<input type="checkbox"/>	8.7	0
10.211.1.180_cam1_roty	<input checked="" type="checkbox"/>	10. roty	<input type="checkbox"/>	0	0

Values are set, if the field has lost its focus.

## 7.2.6 Set Center Shifts

In case a drift of graphics can be seen while zooming the camera, the center shifts might need adjustment (image above shows example values).

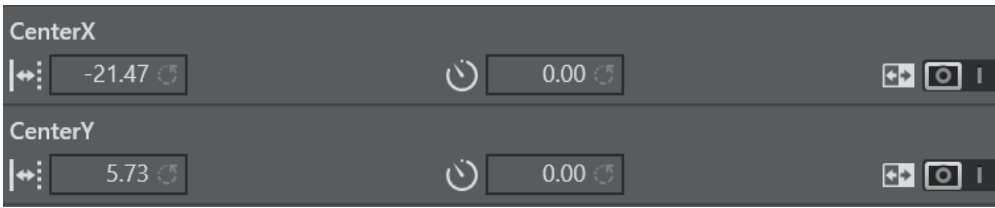

A guide on how to properly adjust center shifts can be found in chapter [Tracking Hub Structural Design](#).

## 7.2.7 Analyze Time

Analyze Time is a visual representation of the tracking.

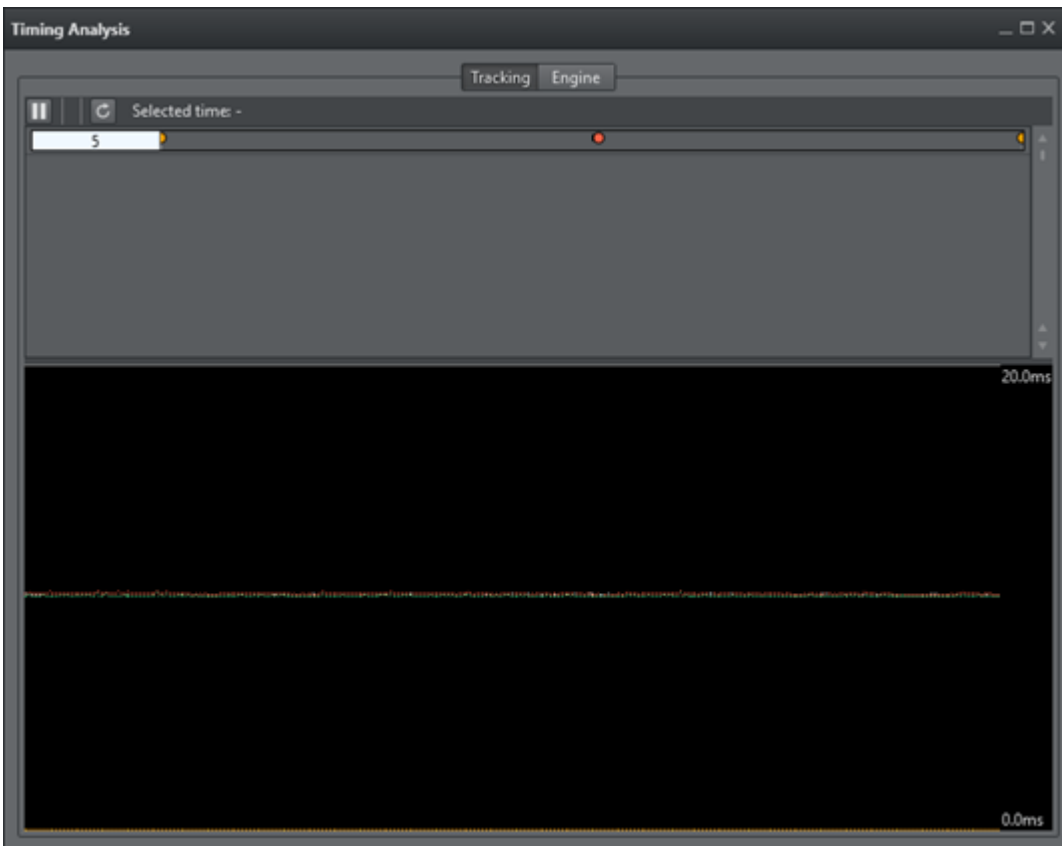

## To Analyze Tracking System Time

1. Right-click on the Tracking System that is to be analyzed and select **Analyze Timing**.

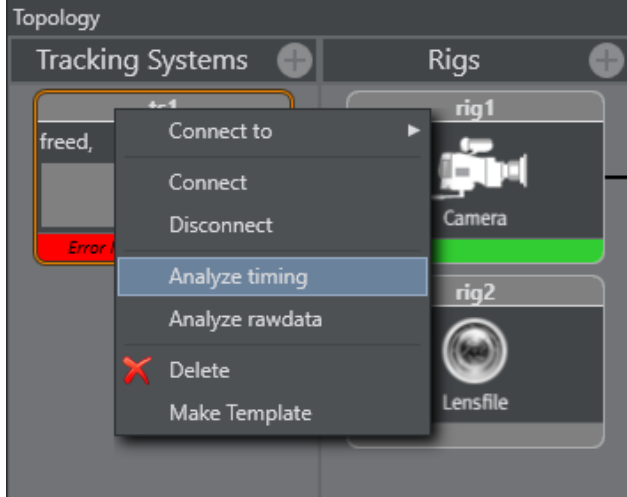

This adds a new element to the **Services** panel, called **TrackingTiming**.

2. Click on the **TrackingTiming** Service element. In the Properties panel, make sure that:
  - The IP of the local PC is inserted, and
  - The service is set to **Active**.

## To Analyze a Service Time

1. Right-click on the Service System that is to be analyzed and select **Analyze Timing**.

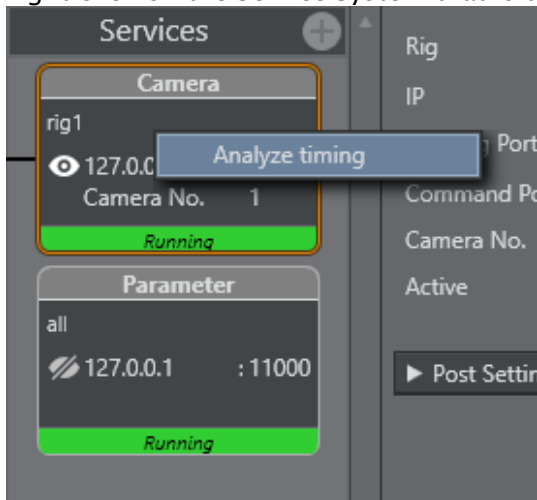

This adds a new element to the **Services** panel, called **TrackingTiming**.

2. Click on the **TrackingTiming** Service element. In the Properties panel, make sure that:
  - The IP of the local PC is inserted, and
  - The service is set to **Active**.

## To View Timing Information

1. In the [Configuration Panel](#), click the **View Timing Analysis** button . In a Timing panel with a correct data stream:
  - **Purple line:** Shows the time when the Tracking Hub has inserted a data package from the tracking system into the data pool.
  - **Green line:** Shows the time when the communication part of the Tracking Hub starts to read from the data pool.
  - **Red Dot:** Indicates data sent to a Viz Engine has stopped.

## Upper Section

In the upper section, the first line is the timing of live tracking data.

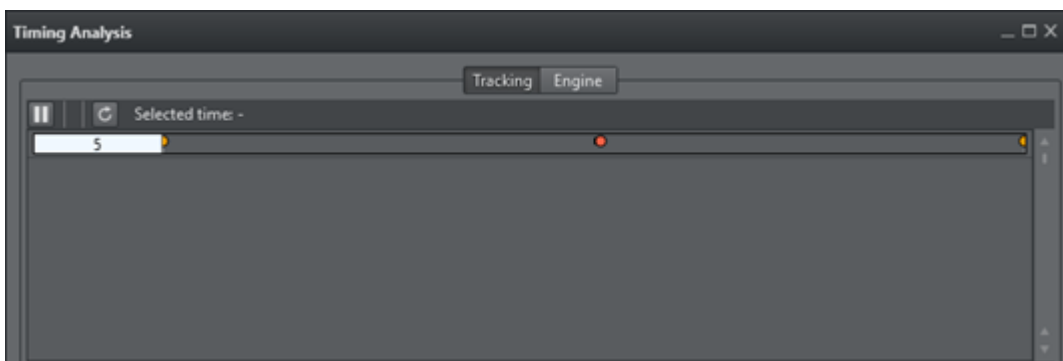

These timestamps are shown:

- **Sync:**
  - **Start RX:** Start time, when data is received from the tracking system.
  - **End RX:** End time, when data stops from the tracking system.
  - **Start Ins:** Start time, when Tracking Hub inserts received data into the parameter pool.
  - **End Ins:** End time, when Tracking Hub has finalized inserting data.
- **Orange Dot:** Sync Timestamp
- **Blue:** The time between **Start RX** and **End RX**

**Note:** The time between **Start RX** and **End RX** can be very short and thus almost invisible if network communication is in use.

- **Purple Line:** The time between **Start Ins** and **End Ins**
- **Line 2:** Shows when the live tracking data is processed and sent to the Viz Engine.
- **Start Calc:** The start time. When tracking data is calculated and prepared for a Viz Engine, this time is defined from send delay. After this delay has passed the Tracking Hub starts with this procedure for calculation and sending data.
- **End Calc:** The end time. When tracking data preparation is finished.
- **End Send:** Time when data has been send to the Viz Engine.
- **Green Line:** Time between **Start Calc** and **End Calc**.
- **Red Dot:** End Send Timestamp

## Lower Section

The lower part shows the last ten second history of the timing. Three timestamps are shown.

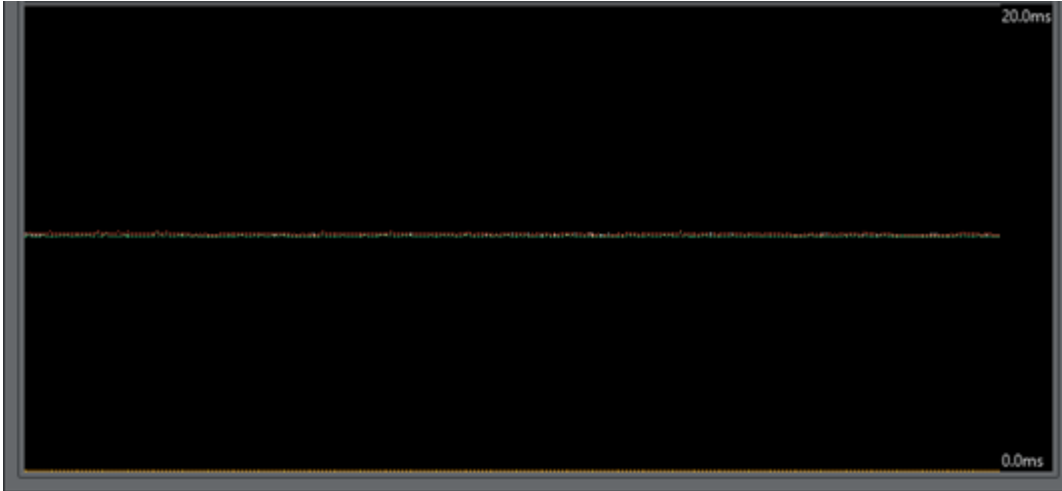

**Note:** Only three timestamps are shown to make the recognition of the timing behavior easier.

- **End Ins:** As time, when receiving is finished, shown in purple (1).
- **Start Calc:** When data processing starts, shown in green (2).
- **End Send:** When Tracking Hub work is finished for this field, shown in red (3).

To get the optimal timing, the **Start Calc** time must be later than the **End Ins** time, for every field. To achieve this, the send delay has to be adjusted correctly. The white line shows the delay. This line should be the absolute border between **End Ins** (purple line) and **Start Calc** (green line). To change the delay, use drag and drop to move the white line. If the delay can not be adjusted correctly, this can be for several reasons, for example, tracking data is received too late.

**Note:** This is not too bad, but keep in mind, that this result is in a tracking delay of one field.

This doesn't matter so much, because in normal production you need more the one field tracking delay.

## 7.2.8 Lens Range Calibration

This section details how to calibrate the Lens Range.

1. First, collect the minimum and maximum Values of Zoom and Focus:



- a. In the Tracking System properties panel, click the **Calibration** button:

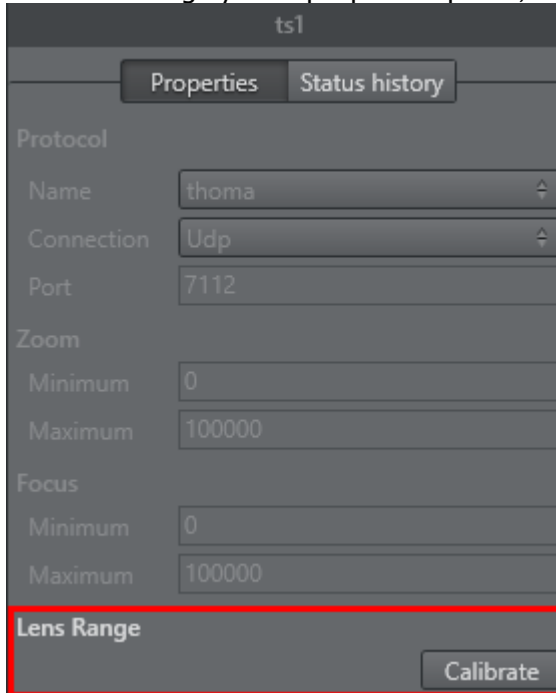

- b. Go to the broadcast camera and move Zoom and Focus to their upper and back to their lower limits, at least two times. Observe that the system receives the full set of data:

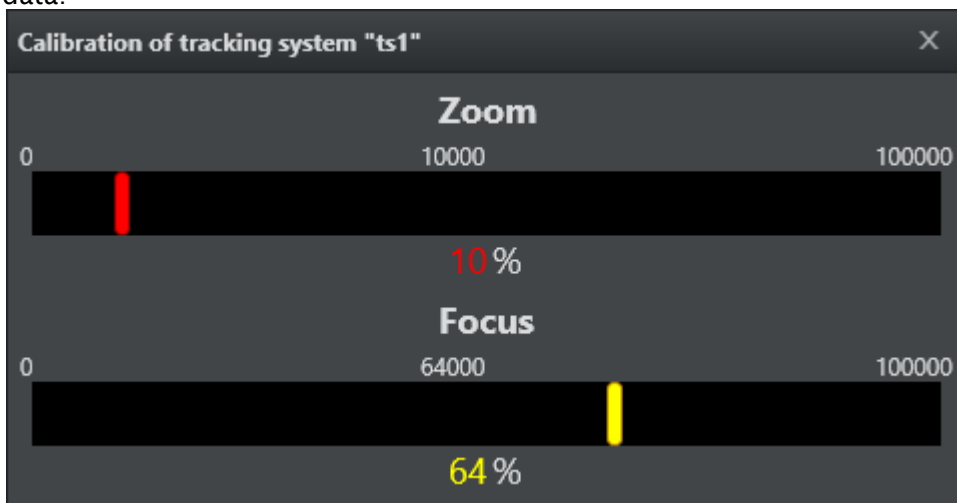

To check if the calculation is correct, the corresponding Min/Max values, of the Lens

encoder, are shown in the **Zoom** and **Focus** fields.

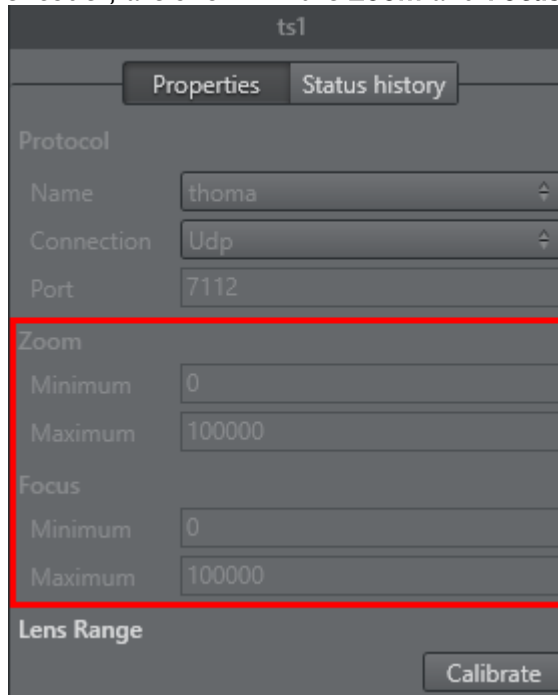

## Re-using Lens Ranges from Older Version Lens Files

The lens range in Tracking Hub is from 0 to 1. For setups used with software preceding the Tracking Hub, such as Viz IO, the lens files may have used lens ranges specified slightly differently, such as from 0.01 to 0.99. The Tracking Hub is capable of adapting to such a lens range. To achieve this, the `lensrange` parameter in the studio configuration file needs to be entered manually.

**Warning:** Editing the configuration manually can lead to software malfunction, and should only be done by qualified professionals.

### 7.2.9 Modify a Rig

If a Tracking System parameter does not equal a Viz Engine parameter, a Viz Engine parameter can be modified to adapt to the Tracking System parameter.

#### To modify a Rig

1. Right-click on a Tracking System. Select **Connect to** a rig.

2. The **Tracking parameter routing** window opens.

Tracking System	Rig					
"ts1"	"R13"					
Tracking parameter	Connected	Name	Inverted	Offset	Delay	
ts1_tilt	ts1_tilt x	Tilt	<input type="checkbox"/>	0	0	
ts1_pan	ts1_pan x	Pan	<input type="checkbox"/>	0	0	
ts1_zoom	ts1_zoom x	Roll	<input type="checkbox"/>	0	0	
ts1_focus	ts1_focus x	PosX	<input type="checkbox"/>	0	0	
ts1_spare5	x	PosY	<input type="checkbox"/>	0	0	
ts1_spare6	x	PosZ	<input type="checkbox"/>	0	0	
ts1_spare7	x	Zoom	<input type="checkbox"/>	0	0	
ts1_spare8	x	Focus	<input type="checkbox"/>	0	0	
	x	CenterX	<input type="checkbox"/>	0	0	
	x	CenterY	<input type="checkbox"/>	0	0	
	x	FrontLensShift	<input type="checkbox"/>	0	0	
	x	HeightLensShift	<input type="checkbox"/>	0	0	
	x	RightLensShift	<input type="checkbox"/>	0	0	

OK

- The **Tracking System** panel shows all the parameters that can be tracked.
  - The **Rig** panel shows the Rig connections.
3. If a Tracking System parameter does not equal a Viz Engine parameter, a Viz Engine parameter can be modified to adapt to the Tracking System parameter. Click on a Viz Engine parameter and drag to its new position, as required. If a red cross shows, after a parameter has been modified, it means that the connection is still valid, but the connection is now a

cross-over connection and not a straight one.

Tracking System "ts1"		Rig "I3"				
Tracking parameter	Connected	Name	Inverted	Offset	Delay	
ts1_tilt	ts1_tilt x	Tilt	<input type="checkbox"/>	0	0	
ts1_pan	ts1_pan x	Pan	<input type="checkbox"/>	0	0	
ts1_zoom	ts1_zoom x	Roll	<input type="checkbox"/>	0	0	
ts1_focus	ts1_focus x	PosX	<input type="checkbox"/>	0	0	
ts1_spare5	ts1_spare5	PosY	<input type="checkbox"/>	0	0	
ts1_spare6	x	PosZ	<input type="checkbox"/>	0	0	
ts1_spare7	x	Zoom	<input type="checkbox"/>	0	0	
ts1_spare8	x	Focus	<input type="checkbox"/>	0	0	
	x	CenterX	<input type="checkbox"/>	0	0	
	x	CenterY	<input type="checkbox"/>	0	0	
	x	FrontLensShift	<input type="checkbox"/>	0	0	
	x	HeightLensShift	<input type="checkbox"/>	0	0	
	x	RightLensShift	<input type="checkbox"/>	0	0	

4. In the **Offset** column, define an offset to each parameter. The values are given in centimeters or degrees (value with dot). The values are stored when the field loses focus.
5. In the **Delay** column, enter how many fields sending of the parameter should be delayed.
6. Click on a box under **Connected** to connect a parameter through the rig.
7. Click **OK**.

## No Tracking Parameters

If the **Tracking parameter** panel empty, there are no tracking parameters delivered from the tracking system.

Tracking System "ts2"		Rig "I3"				
Tracking parameter	Connected	Name	Inverted	Offset	Delay	
ts1_tilt	x	Tilt	<input type="checkbox"/>	0	0	
ts1_pan	x	Pan	<input type="checkbox"/>	0	0	
ts1_zoom	x	Roll	<input type="checkbox"/>	0	0	
ts1_focus	x	PosX	<input type="checkbox"/>	0	0	
	x	PosY	<input type="checkbox"/>	0	0	
	x	PosZ	<input type="checkbox"/>	0	0	
	x	Zoom	<input type="checkbox"/>	0	0	
	x	Focus	<input type="checkbox"/>	0	0	
	x	CenterX	<input type="checkbox"/>	0	0	
	x	CenterY	<input type="checkbox"/>	0	0	
	x	FrontLensShift	<input type="checkbox"/>	0	0	
	x	HeightLensShift	<input type="checkbox"/>	0	0	
	x	RightLensShift	<input type="checkbox"/>	0	0	

1. Check what the icon of the tracking system shows (disconnected or connected, color, etc.).
2. Check all connectors until the required connections show in the Tracking Parameters panel.
3. Go to [To Modify a Rig](#).

## 7.3 Tracked Cameras And Viz Engine

Viz Engine needs to be correctly configured to receive tracking data from the Tracking Hub. For correct configuration, the Viz Engine configuration file must be edited manually following these instructions:

**Warning:** Create a backup copy of the configuration file before changing it.

1. Locate the Viz Engine configuration file. This is normally `C:\ProgramData\vizrt\VizEngine\VizEngine-0.cfg`.
2. Close Viz Engine.
3. Open the Viz Engine configuration file in a text editor like Notepad, the configuration file is a text-file and must be saved after editing as a text file.
4. Locate the **Camera** section in the configuration file and make edits as follows:
  - The flag `trackinghub_port = 3000` must be set to a valid and accessible port.
5. Depending on the transport protocol the flag `use_trackinghub` must be set to `1` or `3`.
  - `use_trackinghub = 1` is used for the standard UDP protocol.
  - `use_trackinghub = 3` is used for tracking data embedded into the NDI stream.

When this is done, Viz Engine no longer waits for tracking data from the discontinued Viz IO. Instead, the Tracking Hub port is opened and Viz Engine sends live signs to the Studio Manager and appears in all dialogs where a Viz Engine can be selected.

If more than one network adapter is present on Viz Engine, the user can bind the live signs and tracing data to a specific network interface. The flag `trackinghub_adapter = <IPADDRESS>` (for example: `10.211.1.65`) must be configured to the adapter IP that should be used. If the flag is empty, the first adapter is used.

**IMPORTANT!** The Viz Engine must be restarted after changing the configuration file.

## 7.4 Router Control

Camera cuts can be controlled from within the Studio Manager by using the **Router Control**, accessible from the **Tools** menu. The Router Control can control camera cuts by using presets, or manually. By adding presets for the most commonly used inputs and outputs, this interface allows for quick and easy camera cuts on demand. When Router Control is in use, an additional configuration file is used. This file is located in `%ProgramData%\vizrt\VizTH\Cfg\<Studio config name>`, and the file is named `XML_TH_RouterCfg.xml`. At any given time, configured connection or preset parameters can be deleted independently from the overall router control configuration by clicking the corresponding trash can icon.

### 7.4.1 To Add a Router Control Preset

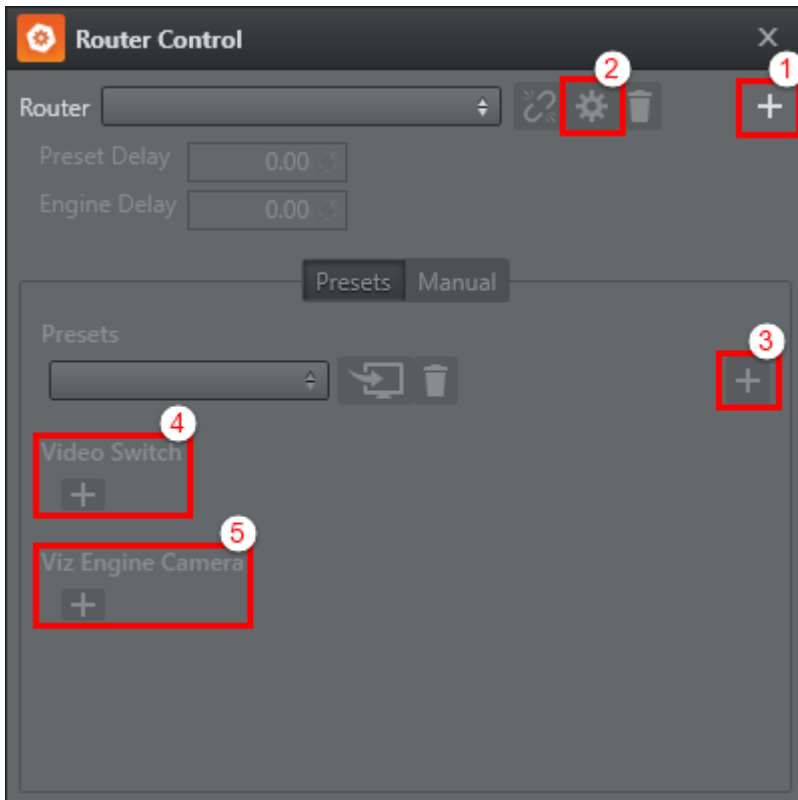

1. Open the **Tools** menu and select **Router Control**.
2. In the dialogue window that opens, select a **Model** and enter a **Name** for the router, then click **Add**. The selected model defines the communication protocol which is used, and is not vendor dependent. The available protocols are:
  - Black Magic (serial)
  - Nevision MRP (network)
  - Nevision NCB (serial)
3. Click the plus icon (+) in the upper right corner to add a router (1). If a router has been added to the system previously, it can be reused by selecting it from the **Router** drop-down list.
4. Click the cogwheel icon to configure the connection settings and **AB** mode for the router (2).

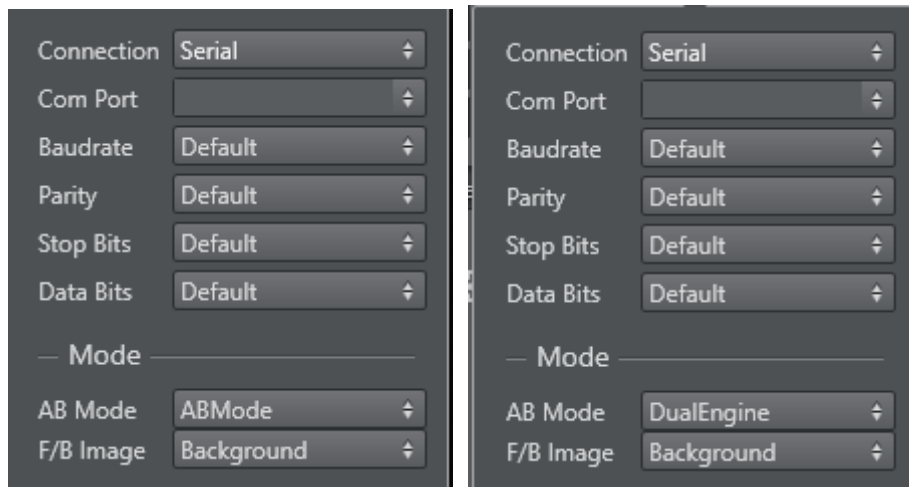

5.
  - **Connection:** Select the connection protocol. Available options are **Serial**, **UDP** and **TCP**. For serial connections, the **Com Port** needs to be set in all cases. The other parameters may be left to their **default** settings, or specified based on the requirements of the specific hardware connected. Please refer to the vendor documentation for connection details.
  - **No Mode selection:** If no mode is selected, Tracking Hub changes the switch points on the router with no internal logic. The following diagram shows a "one machine with two Engine instances and internal keyer" solution which implements a program / preview setup. The two instances hold the same scene. When switching a camera is intended, first the camera on the engine and the video going into the preview engine is switched. When all signals are stable and the camera is switched, the roles of the Engines are modified by changing the signals on Out 3 and Out 4. Therefore, the preview and program role of the Engines change with every switch.

Sync Switching 1 Machine 2 Viz instances with internal chroma keyer

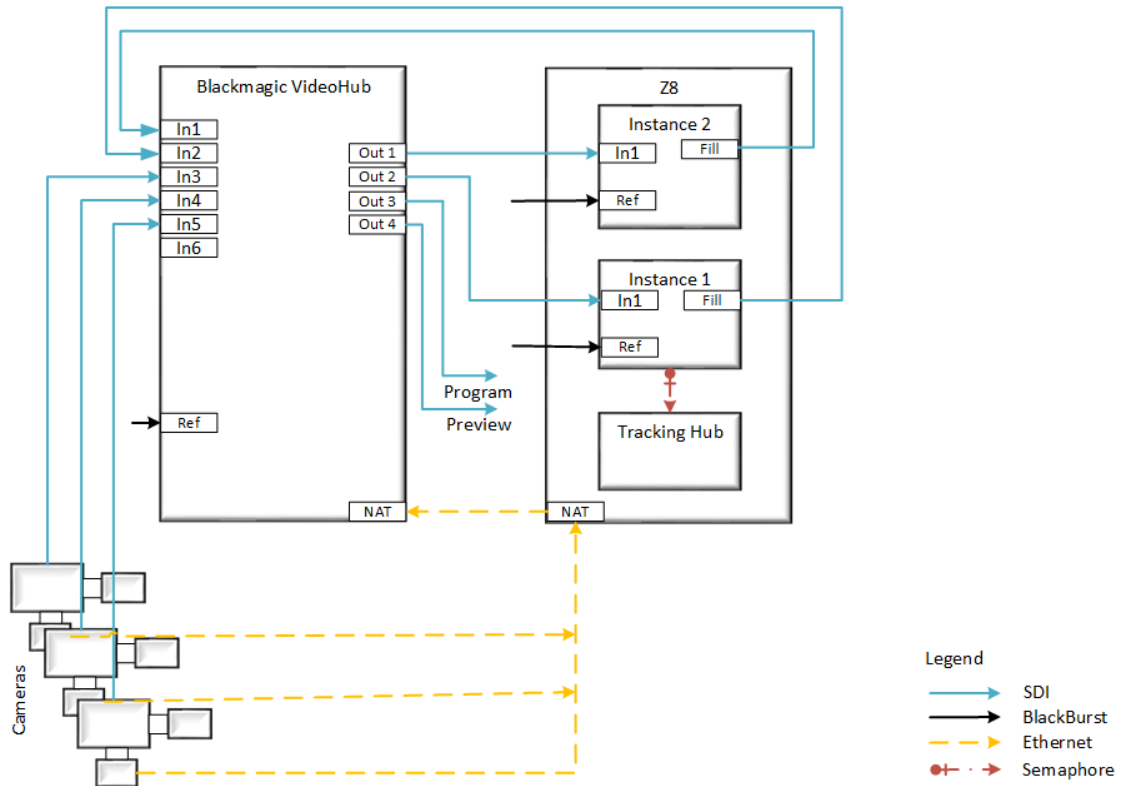

- AB Mode:** AB mode is used to deal with situations with unreliable router switching times. When running in AB mode, two SDI cables are connected from the router to the Viz Engine inputs. Upon switching, the router first switches the signal to the unused line. If the signal is valid, the command to switch the input and camera is sent to the Engine. This way, the output from Viz Engine is not interrupted even if the router switching has a slight delay. This mode can be used, when the video is whether linear keyed from the background or chroma keyed with one of the internal chroma keys of Viz.



Sync Switching 1 Machine 1 / Viz instance internal keyer / 1 router

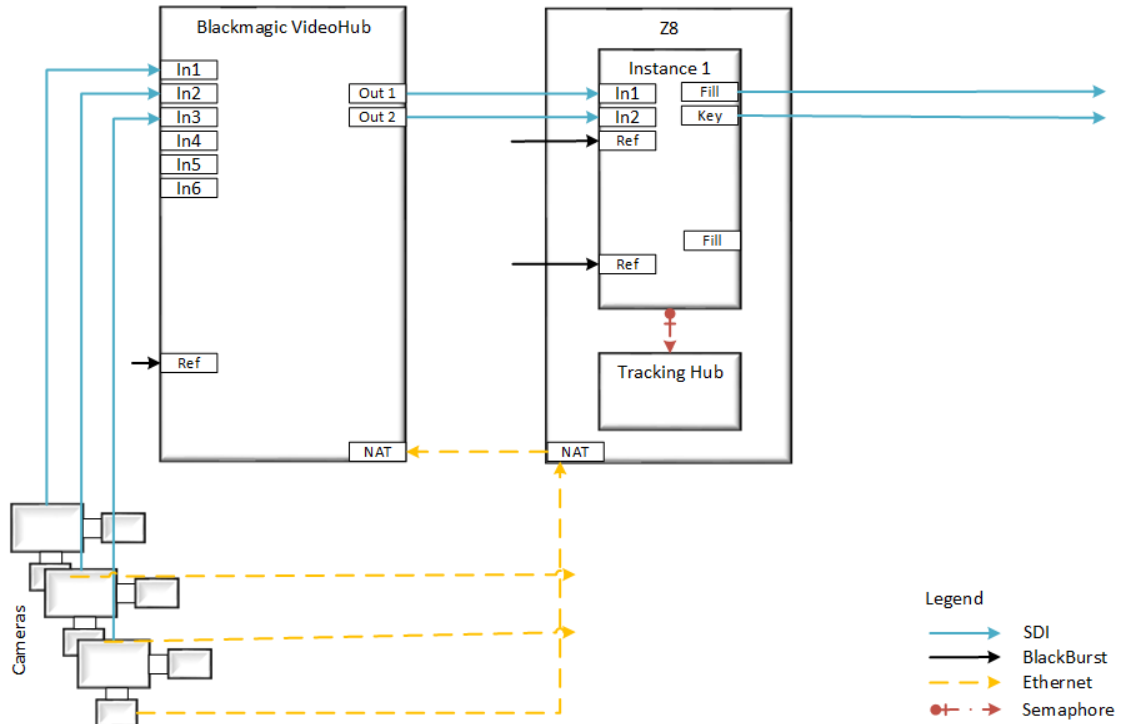

- Dual Engine:** Dual Engine mode is used, when **ONE** and only **ONE** physical Engine machine should handle multiple cameras with a switcher. In the last few years, it became more difficult to find cheap routers which are able to switch with predictable timing. The method described here makes it possible to use the already implemented A/B mode in Tracking Hub with an external keyer, like the Ultimatte 12. The goal is to create a low cost virtual set with an arbitrary number of cameras with a one machine solution. On this machine (preferably a Z8 with an x.mio3 and two graphics adapters) a dual Engine is installed with a Tracking Hub. Let also assume, that a BlackMagic Video Hub (or any other cheap router) and an Ultimatte 12 are present. In this scenario, the Video Hub is connected via Ethernet to the VSS machine. In Tracking Hub, a new switching method is added to the existing A/B mode. In this mode, the user can enter the IP and port of the first and second instance of the Engines. The router is managed by the selected protocol driver. When selecting this mode, the following steps occur: Tracking Hub takes over instance two and generates a basic scene with two inputs by using the command interface. Using this method ensures that instance two, which is responsible for the synchronized switching, is in place and ready. Tracking Hub also checks if the instance is present and On Air, that all inputs are enabled and that the sync source is set and the instance is locked. Tracking Hub contacts the video hub and make sure that it is reacting.

Then the user is able to enter any amount of presets in the matrix controls of Tracking Hub. Switching can, like before, happen by GPI, commands or any future interface.

In case of switching the following occurs:

Status: Tracking Hub knows the actual status of the active output of instance two.

There is always an active and inactive input present on instance two.

When a new camera is activated by a preset, Tracking Hub commands the router to switch this video feed to the inactive input of instance two. After that Tracking Hub waits a defined (by user) timespan, until the signal is stable switched and valid on the Matrox input. If necessary, Tracking Hub can check if everything is OK at the Engine by command interface, and no error messages are coming in.

After that period, Tracking Hub triggers a synchronized command to instance one and instance two (with the necessary delays) to switch camera on one and video on instance two.

This workflow can then be repeated an unlimited number of times.

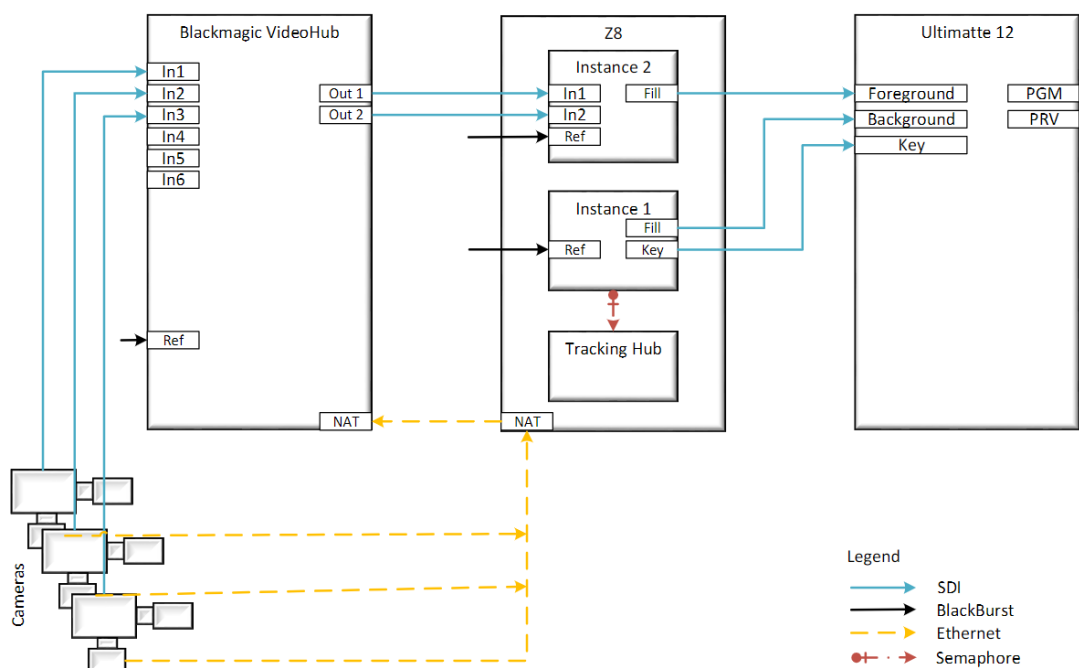

6. If required, a delay can be added in the **Preset Delay** or **Engine Delay** fields.

7. Next, click the plus icon (+) to the right in the **Preset** section to add a preset (3). Enter a **Name** and click **Add**.

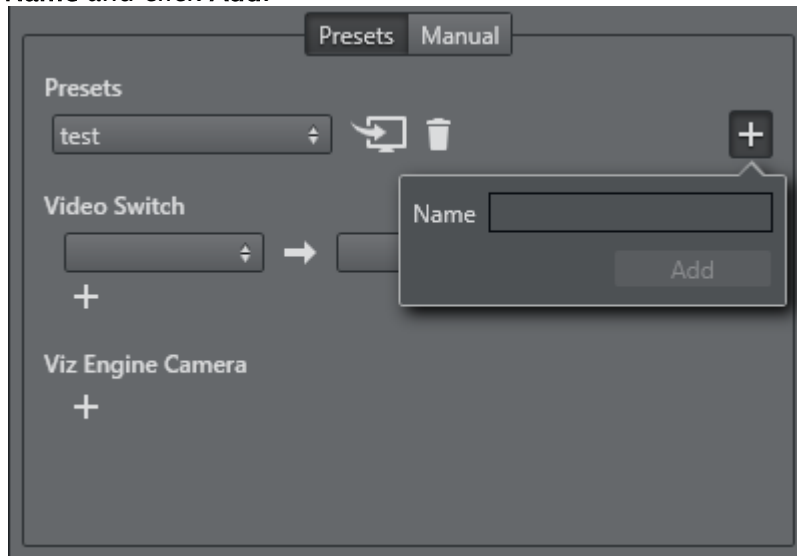

8. In the **Video Switch** section, select the **Input** and **Output** on the router from the left and right drop-down lists, respectively.
9. In the **Viz Engine Camera** section, select which Engine and camera to switch to.

A router connection with a preset has now been configured, and the Router Control window should look like this:

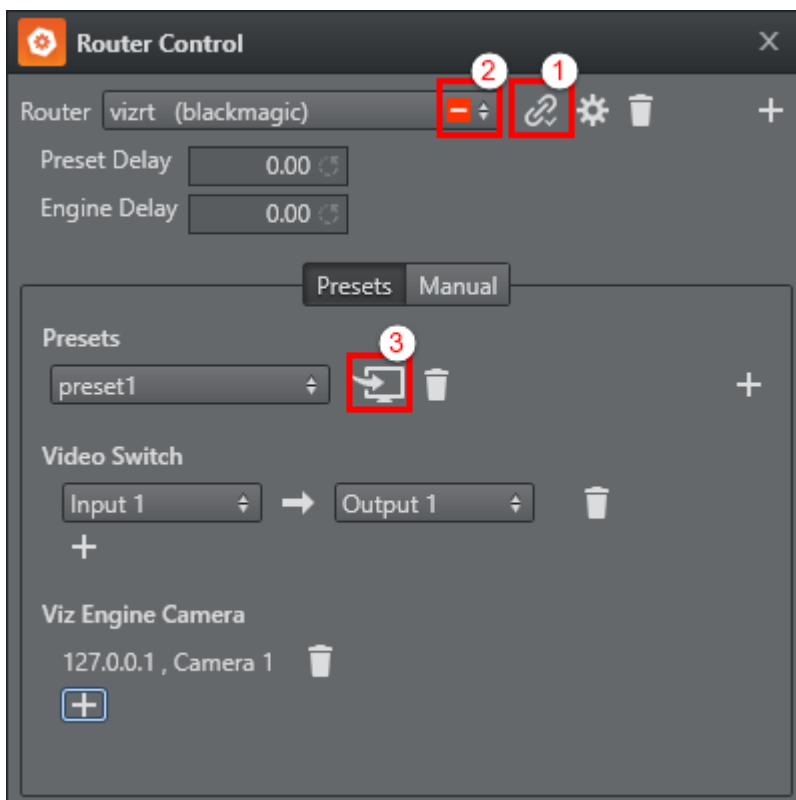

Click the **Connect** button (1) to connect to the configured router. If there is a connection problem,

this is indicated by a red warning box in the **Router** drop-down list (2). To issue the take command to the router and Engine, click the **Take** button (3).

When using *DualEngine* mode:

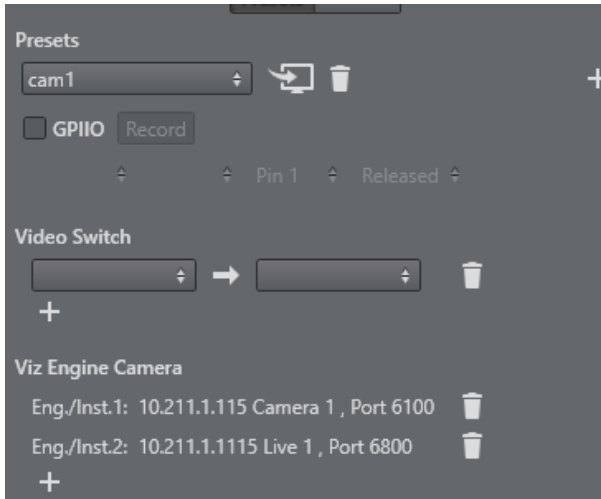

The first Engine is the Renderer, and the Engine camera is switched on this instance. The second Engine is the Video instance, and the video is switched on that. In the picture above you can see, that Engine one is Titled as *Camera Nr.* while Engine two is marked as *Live Nr.*. In Dual Engine mode, it only makes sense to configure two Engines. Please note that in the Engine instance settings, the field *Port* has been added!

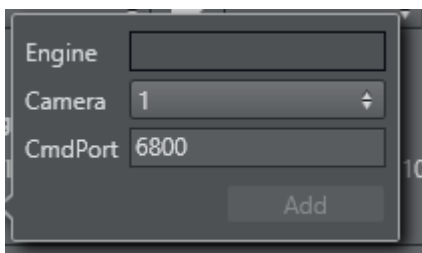

By default the port for instance one is: 6100 and the port for instance two is: 6800 . But this settings can differ from installation to installation. Please check the Engine configuration for the correct port settings.

## 7.4.2 GPI IO Device Switching

In addition to the standard configuration, you can add a **GPI IO** device for switching (4). You can select this device if it was detected during startup. This detection is done automatically.

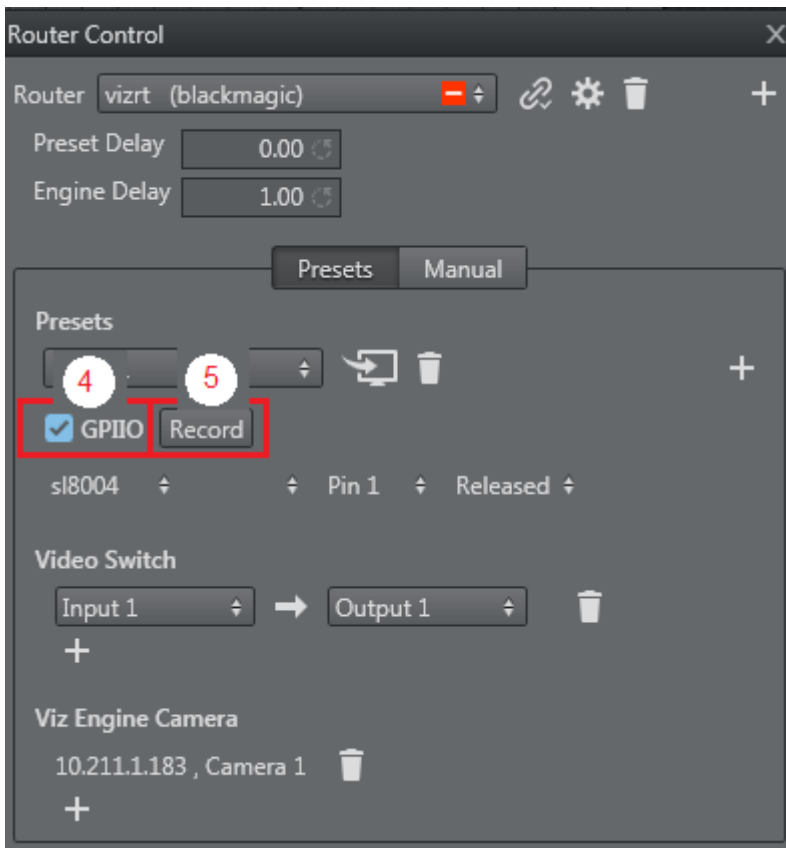

To configure the device, you have two options:

- **Manual:** Select the device, the port (not available for all devices), and the pin. In addition, you can select if the switching should react on pressing or releasing the button.
- **Automatic:** Click **Record** (5) and then select the button on the GPI IO device. The button is recorded and connected to the actual preset.

## 7.5 Backup Configuration

In the case of a backup operation, both Tracking Hubs send tracking data to the Viz Engine(s). To prevent the continuity warning message appearing repeatedly on the Viz Engine console, set the following configuration flag in the Viz Engine configuration file:

```
trackinghub_warning_level = 1
```

You must configure the **Network settings** on both Tracking Hubs (see [Start Viz Virtual Studio](#)). Go to **Tools > Settings** to set up a backup Tracking Hub.

**Settings**

TrackingHub License Interface Grid Spacing Auto Log in

**Network Settings**

VIZ IP: loopback pseudo-i  
 Defines which network adapter TrackingHub uses as viz interface.

TRACKING IP: loopback pseudo-i  
 Defines which network adapter TrackingHub uses as tracking interface.

PARAM. SERVICE PORT: 11000  
 Defines which port is used for receiving Parameter Data.

WEBSOCKET PORT: 9090

LensFileeditor: HTTP://127.0.0.1:9090  
 Defines which port is used for websocket Communication (Lensfile Editor).

Copy to Clipboard Open Browser

TrackingHub needs to be restarted for changes to take effect.

**Backup Role**

Role: Master

**Backup TH**

Backup IP: 10.211.1.26 Synchronize Status

**CenterShift**

Interpolation

Save Cancel

Click the drop down menu to open a selection of available Tracking Hubs. You must select the respective other for both Tracking Hubs. For example:

TH1 has IP: 10.211.1.153	TH2 has IP: 10.211.1.183
Backup TH: 10.211.1.183	Backup TH: 10.211.1.153

Click **Synchronize** to synchronize the configuration from one Tracking Hub to another.

**Important:**

- The *senddelay* value must be set manually on each Tracking Hub, to different values (e.g. 8 and 12 ms). This value is not synchronized.
- When using serial interfaces, they might be different on these PCs. Always inspect the selected COM ports after synchronization, and, if necessary, modify them.

## 7.6 Use Of Templates

You can use templates for an easy and fast configuration of several studios. There are several pre-made templates available in *C:\ProgramData\vizrt\VizTH\*. You can also create your own templates. However, you must copy them to the Tracking Hub directory on a new installation.

### 7.6.1 Using Existing Templates

1. Go to **Tools > Create System From a Template**.

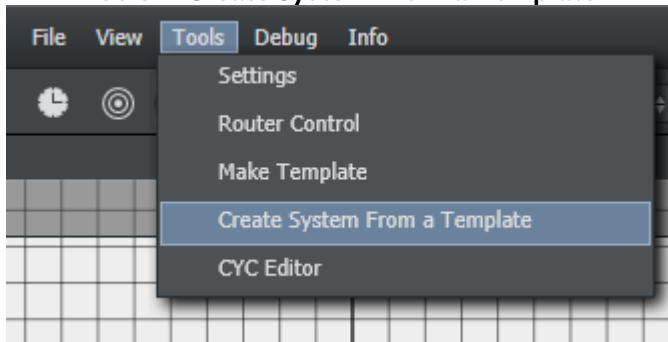

This opens a new window where you can select a predefined template.

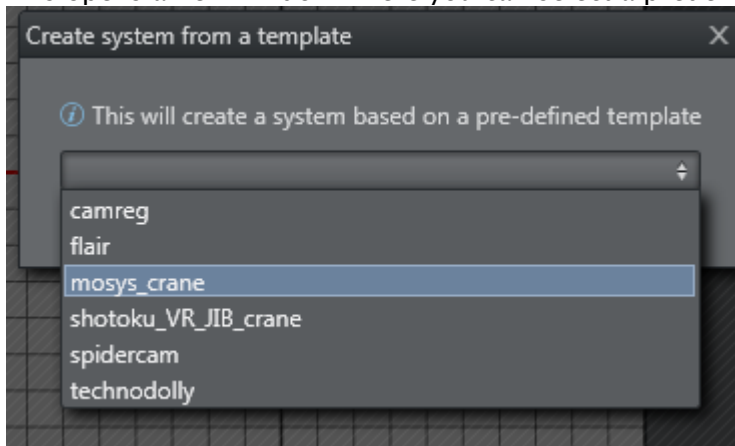

2. After clicking **Create**, you get a complete system consisting of at least one Tracking System, one rig and one service. Depending on the template, it can include several Tracking Systems

and rigs.

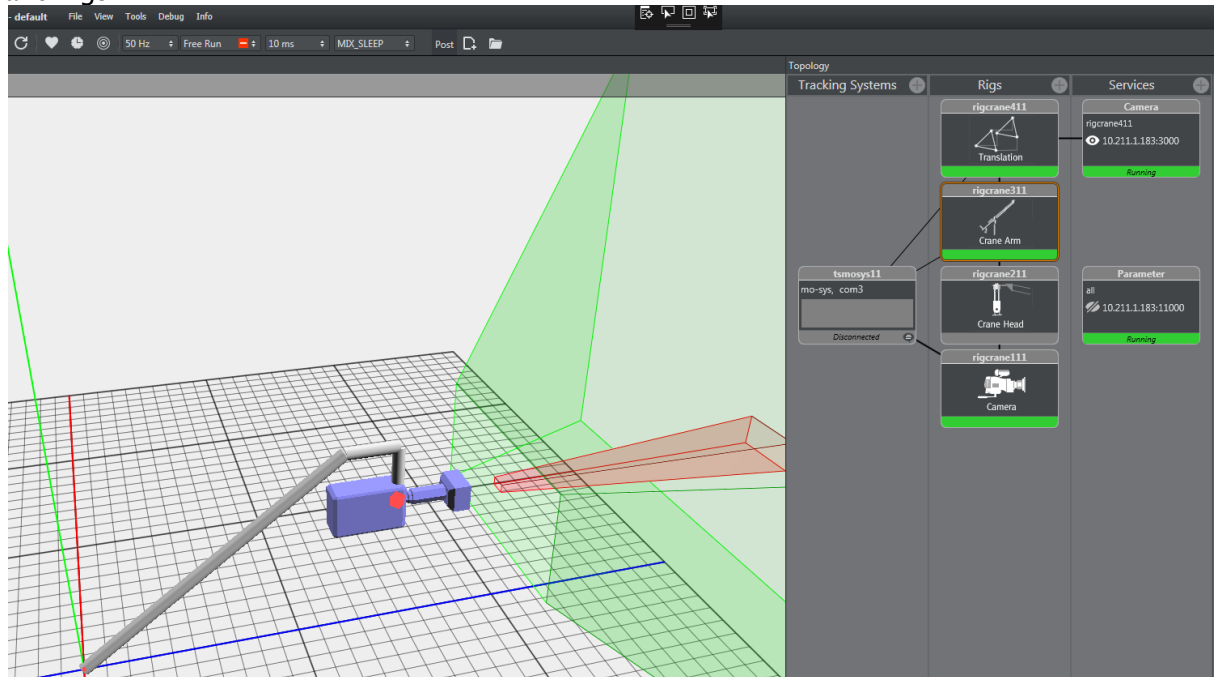

3. Configure the individual settings as applicable:
  - Interface of the tracking system.
  - Set the correct COM or UDP port.
  - Insert the correct IP address for the Viz Engine.

## 7.6.2 Creating New Templates

If you want to reuse a complete system, you can create your own template for it.

1. Go to **Tools > Make Template**.

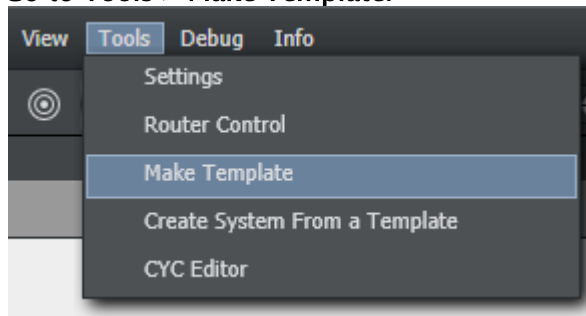

This opens a new window where you can select the parts for your template:

**Important:** Do not select **Parameter** in the **Services** column!



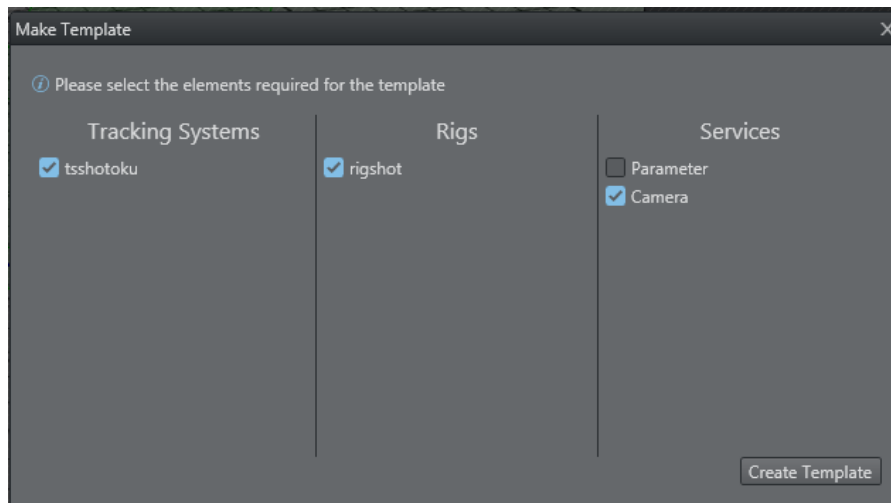

2. When you have selected you items, click **Create Template** and enter a name for the template. Then click **Save As**. This saves a new template in the `C:\ProgramData\vizrt\VizTH\Templates` directory, in a file called `XML_TH_Temp_your_name.xml`.

## 7.7 Replay Tool

- [Prerequisites](#)
  - [Software](#)
  - [Video Hardware](#)
- [Preparations](#)
  - [Viz Engine Configuration](#)
  - [Service Host Configuration](#)
  - [Channel Recorder Client](#)
  - [Tracking Hub Configuration](#)
    - [Service Host Section](#)
    - [Clips Section](#)
  - [Replay Tool](#)
    - [Replay Group](#)
      - [Clip Section](#)
      - [Play Section](#)
      - [Feedback Section](#)
      - [Replay Live Section](#)
    - [Record Group](#)

The Replay Tool can be used to record time code stamped clips with the help of Service Host and a Channel Recorder plug-in. Any time code which is readable by Viz Engine can be used. Most cameras already insert at least one readable time code.

To use the tool, some prerequisites must be met and some configuration settings modified. In the following sections, a step-by-step description of the preparations are given.

## 7.7.1 Prerequisites

### Software

The Replay Tool was tested with the following software versions:

- Viz Engine 4.3
- Viz Artist 4.3
- Service Host 2.0
- Tracking Hub 1.5
- Studio Manager 1.5

Please install the packages above in any order. If older versions are already installed, uninstall them first.

### Video Hardware

- Matrox XMIO 3/5
- Matrox DSXLE 4

## 7.7.2 Preparations

### Viz Engine Configuration

After initial installation of Viz Engine, launch the Viz Engine configuration and activate Clip Channel 1 and Live Video In 1.

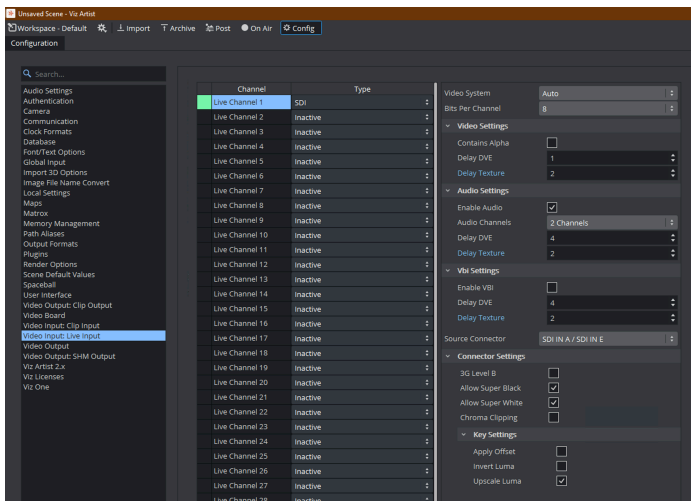

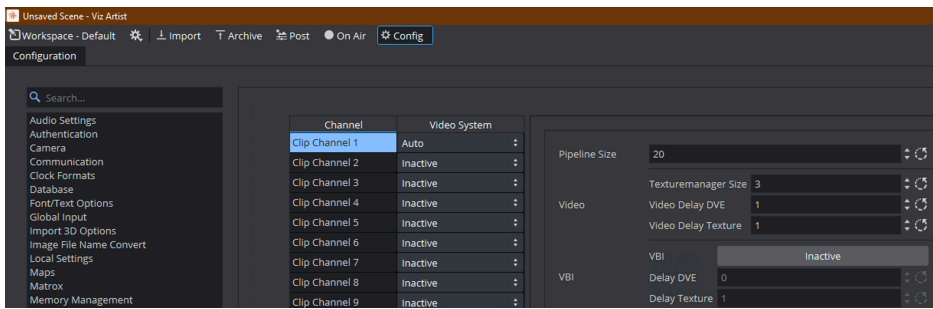

Make sure that in the Matrox section *Fast Texture Mode* is activated. This setting is mandatory for Virtual Set installations.

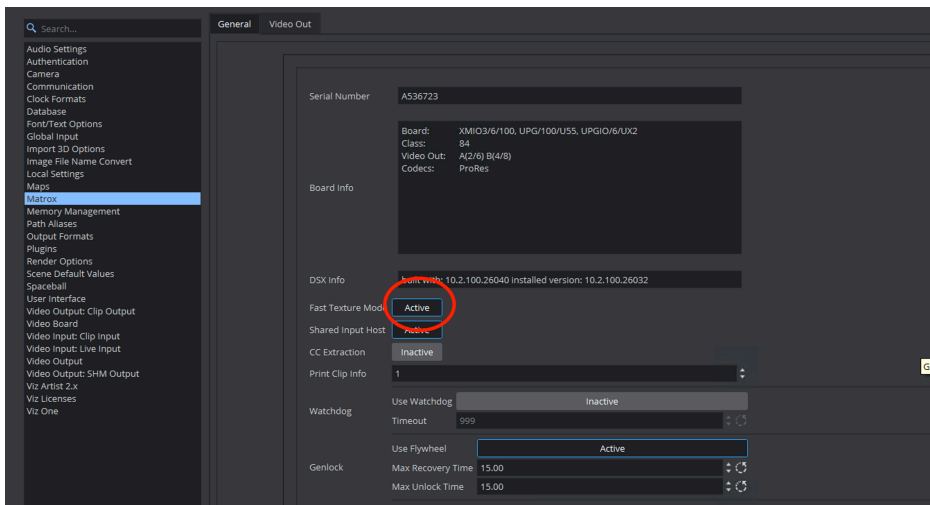

After these first steps close Viz and open the config file. Please make sure, that in the section "MATROX\_CONFIG" *Matrox.FastTextureMode* is set to `1` and that *Matrox.InputHost* is set to `1`.

```
#####
SECTION MATROX_CONFIG
#####
##
## matrox devices common
##
Matrox.Devices = A536723
## Enable fast texture input mode.
## ATTENTION: in this mode DVE will not work.
#* Matrox.FastTextureMode: Default=0
Matrox.FastTextureMode = 1
## Set this to true, if the physical inputs on this engine are to be used as shared
resources in additional engine instances.
#* Matrox.InputHost: Default=0
Matrox.InputHost = 1
```

After that, go to the *Clip in channel: 1* section.

```
##
## Clip in channel: 1
##
```

Make sure that the selected clip player is set to `0: Matrox`. The VML clip player does not work with time code!

```
## Default clip player to be used for this channel. This is only relevant when Matrox
board is used and io_mode is configured to V4. 0=Matrox 1=VML
##* ClipIn1.Player: Default=0 Min=0 Max=1
ClipIn1.Player = 0
```

## Service Host Configuration

If there is an older version of the Service Host installed, it must be uninstalled first. It is recommended to use the default connection settings for the installation, as the ports are preconfigured in the Replay Tool.

Please refer to the [Service Host Administrator Guide](#) for further information.

## Channel Recorder Client

Channel Recorder is a plug-in for Service Host. It enables recording of video inputs at the same time as Viz is using it for rendering. A detailed documentation of all settings is given in the [Service Host Administrator Guide](#). A brief example which is needed for the Replay Tool is provided in the following Section.

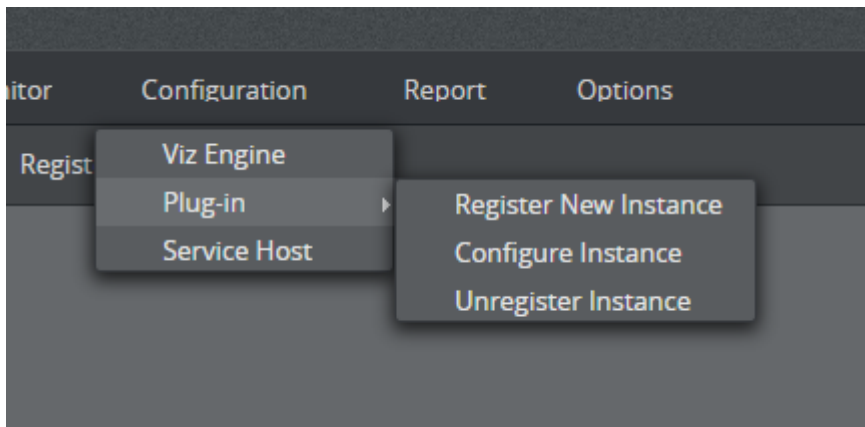

Open the Service Host UI in a web browser. Click on **Configuration > Plugin > Register New Instance**. Select *ChannelRecorder* and then click on **Apply**.

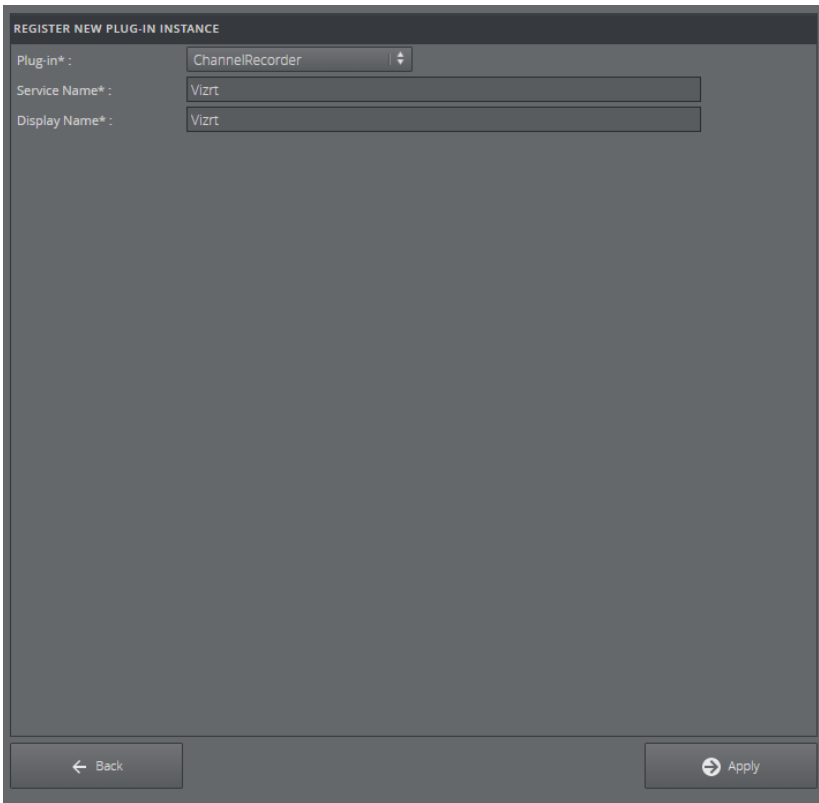

After this step, a new plug-in can be found within Service Host.

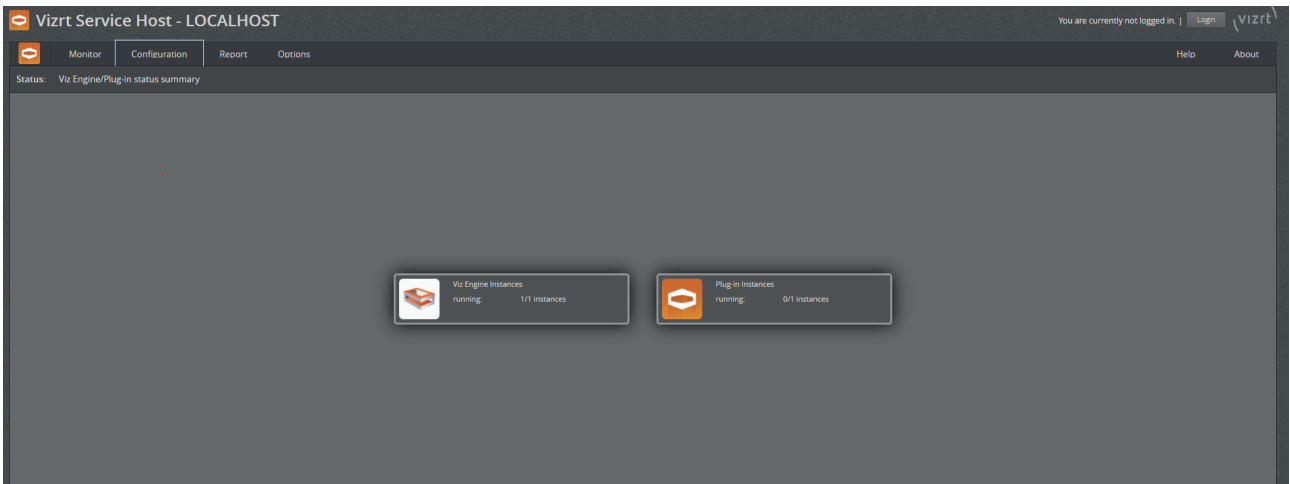

The next step is configuring the plug-in. In this example, Input connector A is used for recording. The clip folder is located at *D:/cr\_clip*. The plug-in stores all recorded clips in this folder. Select the video resolution and aspect ratio needed for recording record.

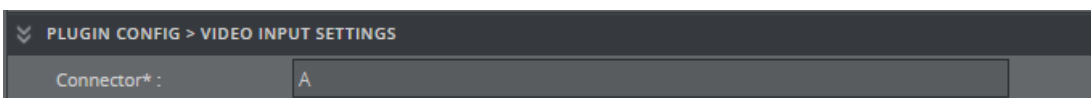

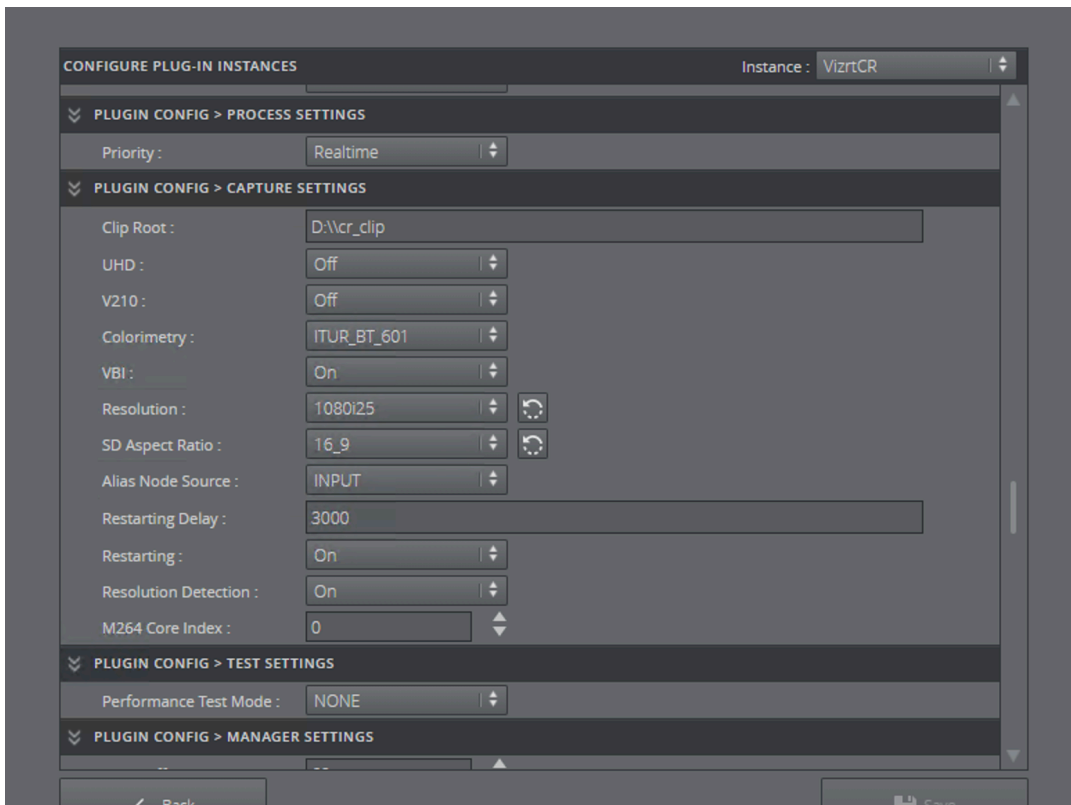

Scroll down to the **Scheduler Settings** and select VITC as Timecode Source. In the clip settings the codec and container can be selected. For more information on what codec and container is usable for the selected resolution in Viz Engine, please refer to **Channel Recorder > References and Specifications > Supported Codecs** in the [Service Host Administrator Guide](#). If recording does not start, check the log file of the Channel recorder and follow the instructions there.

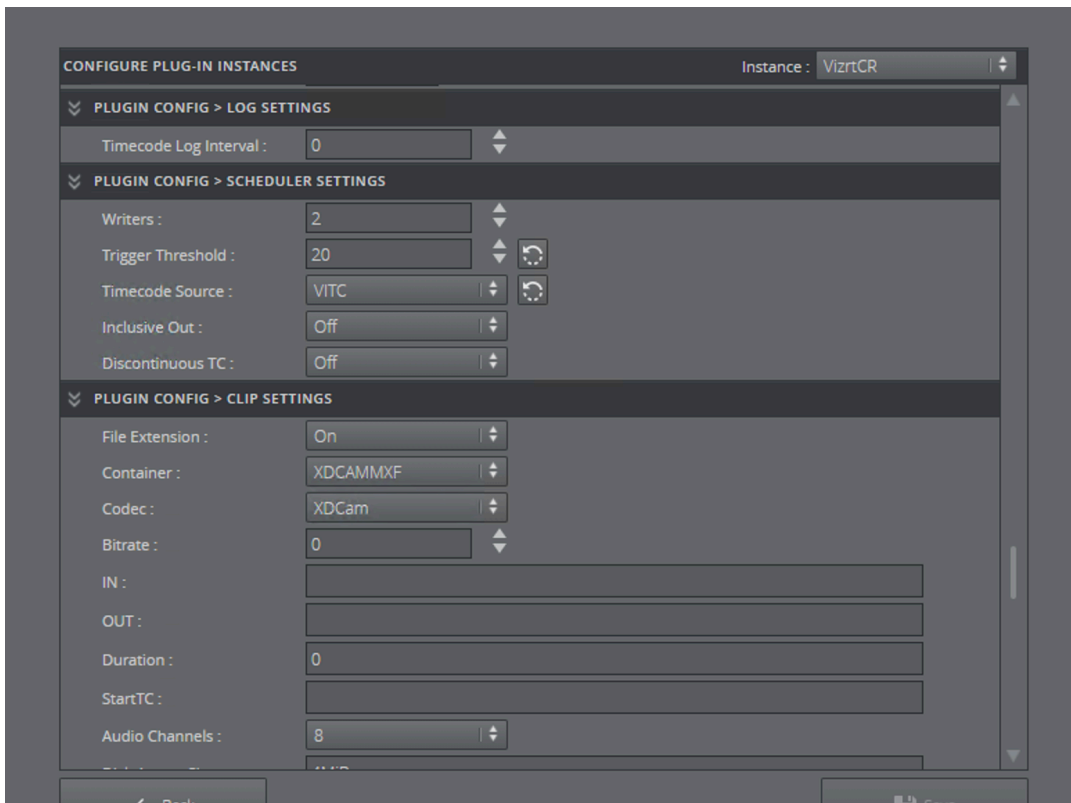

Make sure that Viz Engine is running before starting the instance. Otherwise, the service is not able to record properly and the recorded clip will be black.

## Tracking Hub Configuration

Please refer to the section [Post System](#) and configure the setup for recording. To receive time codes from the Engines, add a Timecode service and connect it to the Engine. Tracking Hub requests all time code sources from the Engine and adds them as sources in the post settings. The Engine must be On Air when the service is activated, otherwise the commands to receive the time code services fail.

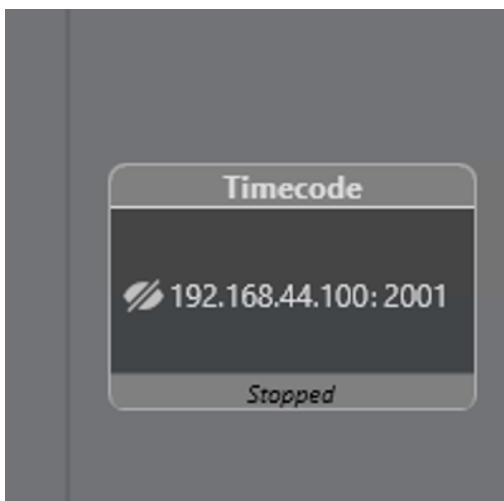

As post time code select *Clip1/RP188VITC* as live time code select *Video1/RP166VITC*. The live time code should be taken immediately.

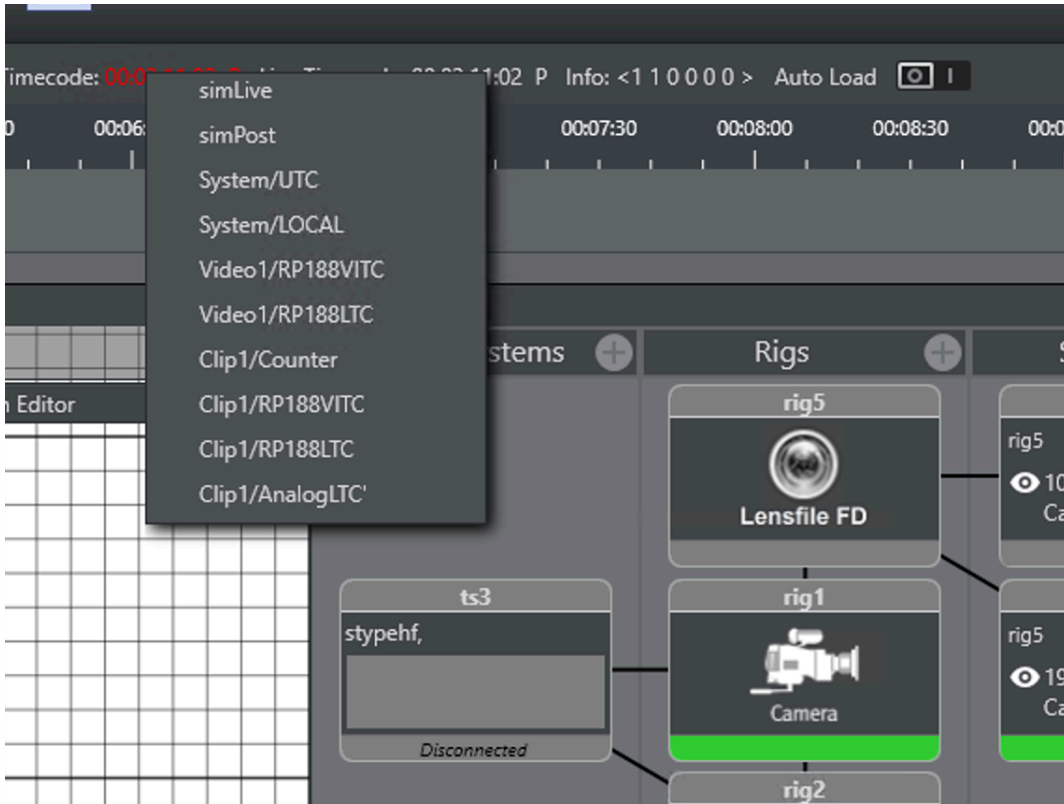

Select the parameters which should be recorded.



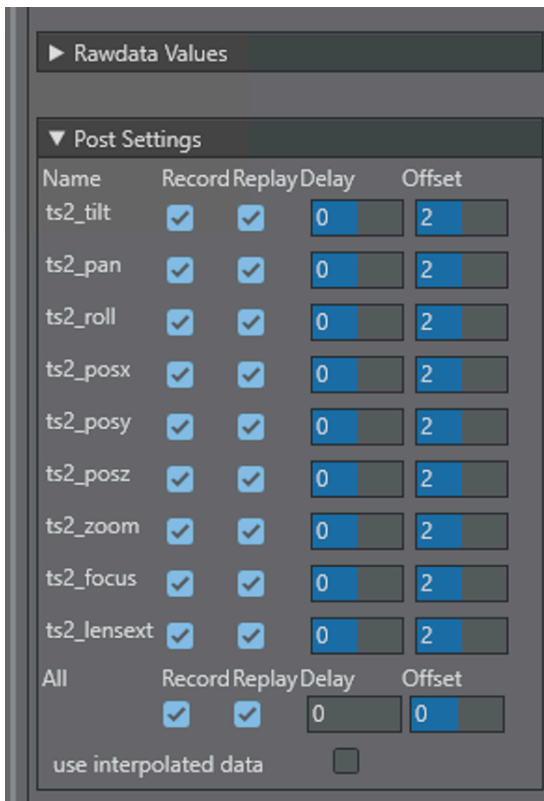

The press **Record** in the Post Tab.

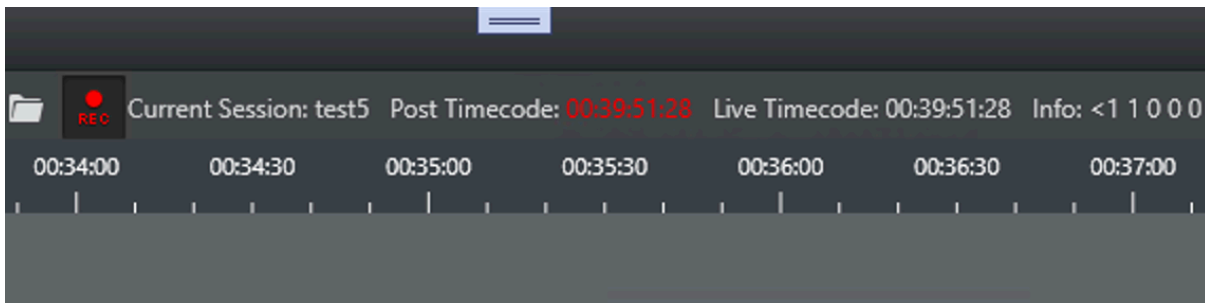

After the recording session has started, open the Replay Tool. The tool is located under **Tools > Replay Tool**.

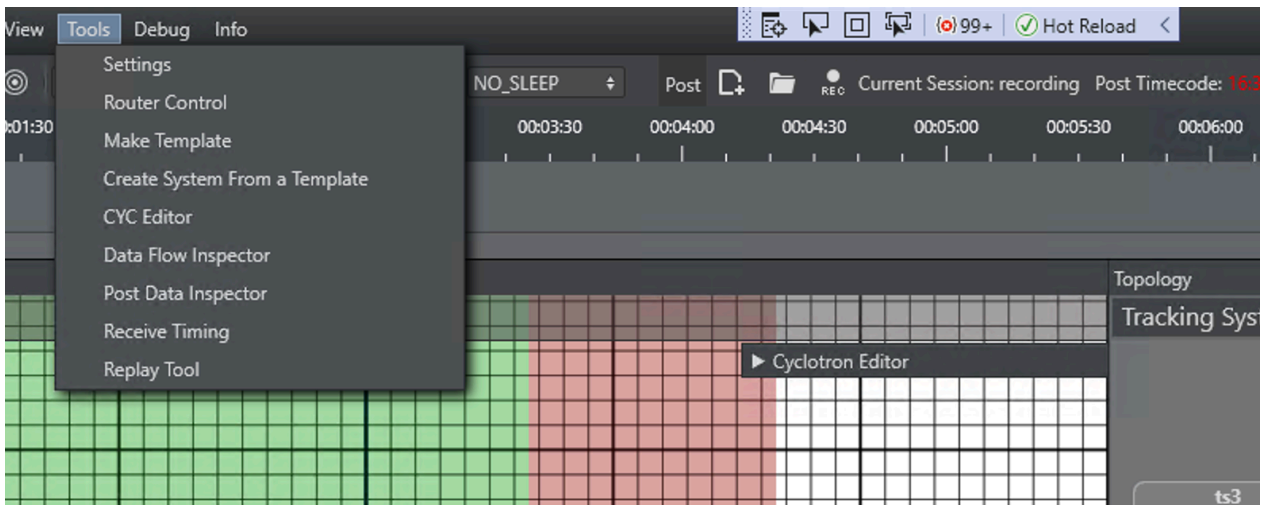

The connect window opens. The first step is to connect to the Service Host instance. Select the IP address of the Service Host and enter the configured port (default 9000) . After pressing **Connect**, a connection is established and all plug-ins installed on the Service Host are analyzed.

If the **Connect** button is not enabled, Studio Manager was not able to find a correct installed Engine on this IP address. Please check if *use trackinghub* is activated in the Engine configuration and that the correct IP address is provided.

## Service Host Section

Select the Channel Recorder plug-in to be used for recording from the *ChannelRecorder* drop down. The connection also reads the Engine instance out of the configuration. It is normal that the Viz Engine Instance reports *not connected* after this step. The connection is established after the final connect. It is important that an Engine instance was found in the Service Host configuration. It is also important that Viz Engine was started and the plug-in instance has been started after Viz Engine.

- **IP:** Shows the Service Hosts IP address.
- **ChannelRecorder:** Shows all channel recorder plug-ins installed on the Service Host.
- **Engine Instance:** Shows all Viz Engine instances running on the Service Host. It also checks whether Viz Engine is running.

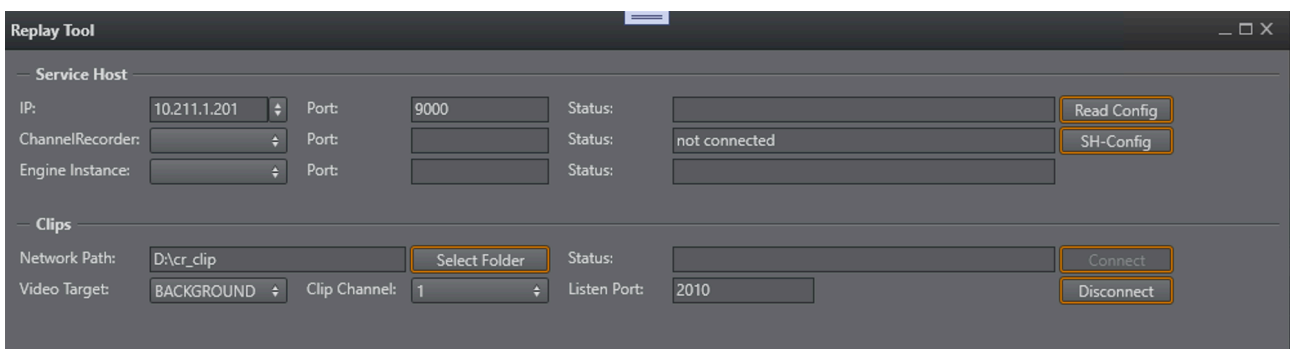

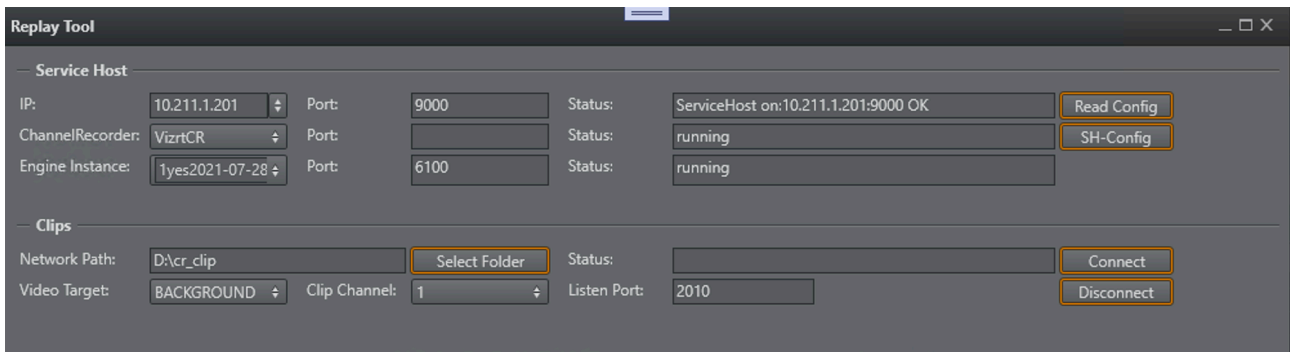

## Clips Section

The next step is to connect a clip folder. If the Replay Tool runs on the same machine as the Engine, you can simply select the clip folder which was configured during Service Host and Channel Recorder installation. If the control runs on another Engine, it is necessary to map the clip folder from the Engine to the local machine, the Replay Tool is running.

To map a network drive, open Windows Explorer and right click on the *This PC* entry. Then select *Map Network drive* and browse to the folder you shared on the Engine. Please refer to the Windows manual on exact instructions for Mapping Network drives.

To find the correct mapped or local folder, click on *Select Folder*. A dialog opens where you can browse your computer. If the folder is still valid from the last session, you can now click **Connect**. If everything goes well, the configuration dialog is hidden and the Replay Tool opens the Replay tab.

The *Video Target* defines, if the clip and live video is played either in Foreground or Background. In case of a Virtual Studio with chroma keyer, select FOREGROUND. In case of Augmented Reality, use BACKGROUND.

The Listen Port defines the feedback port the Replay Tool is registering its information channels. Usually, there is no need to change this value, the only exception is, when another application uses the same ports.

Press **Connect** to continue.

## Replay Tool

It consists of two tabs. The Replay Tab and the Record Tab.

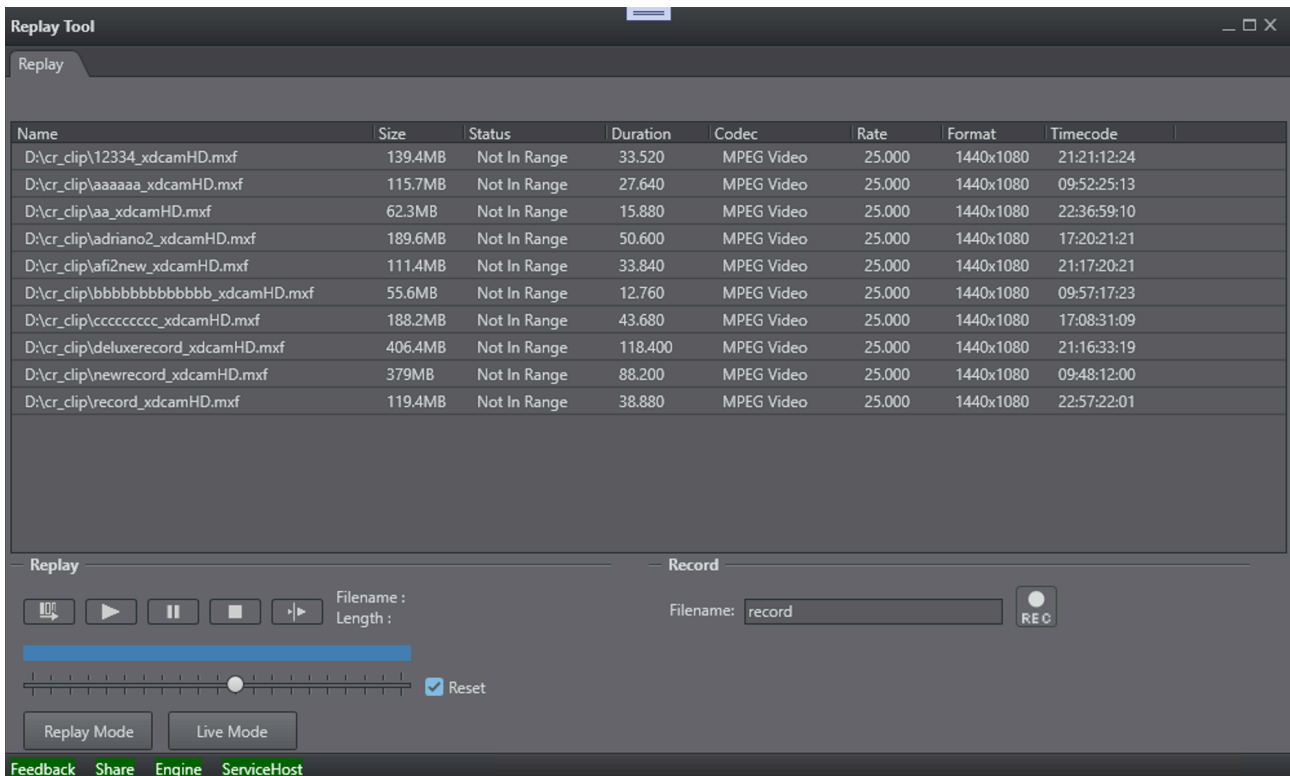

## Replay Group

### Clip Section



In the clip section the tool observes the clip folder and continuously analyses changes. The analyzer is able to read timecode, format, length, duration and format info from the clips. In the case of multiple time codes in the clip, the first one is used. This time code information is used to display if tracking data for the clip is actually in memory.



Select a clip to continue.

### Play Section



The Play section consists of five buttons to control the clip player of Viz Engine. The commands are sent directly by the Replay Tool. The IP and Command port of the Engine is read from the Service Host configuration.

-  **Take:** Loads the selected clip from the clip section into Viz Engine. As soon as the clip has been loaded, its name is visible in the Feedback Section.
-  **Play:** Starts the clip playback from beginning.
-  **Pause:** Stops replay at the current location. If you want to continue playing, press **Continue** instead of **Play**.

-  **Stop:** Stops the clip and makes it disappear from screen.
-  **Continue:** Resumes playback of the clip from the position pause was pressed.

## Feedback Section

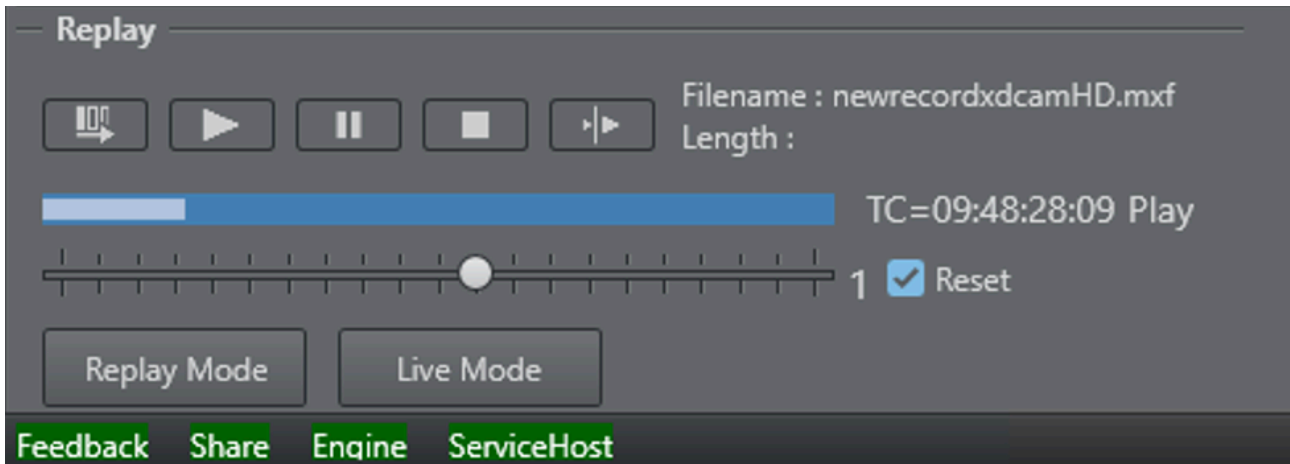

The Feedback Section reflects the clip channels feedback given from the Engine. During connect, the Replay Tool registers several feedback channels. One of them is the *clip loaded* feedback, which is triggered when a clip is ready for replay in the Engine. Therefore, *Clip Name* reflects the actual clip loaded in the Engine. If you try to load a clip with the **Take** button and the name does not appear in the *Clip Name* field, something went wrong or the clip is not playable. Please refer to the Viz Engine console for error messages.

The second feedback channel is the *Clip Position* channel. It is displayed in a progress bar and the position reflects the actual position which is played out in the Engine at this moment.

The third registered feedback channel is the actual timecode, which is played out by Viz Engine. The actual timecode is shown on the right side from the progress bar. This text field also shows the playback status of the clip.

On the bottom of the position progress bar the playback speed can be adjusted. By default the slider is set to 1 which is the default playback speed. You can drag the slider and adjust the speed from -10 up to 10. The reset button on the right side defines what happens if the user releases the slider. When **Reset** is selected, the speed returns to 1. If reset is not checked, the selected speed is kept.

## Replay Live Section

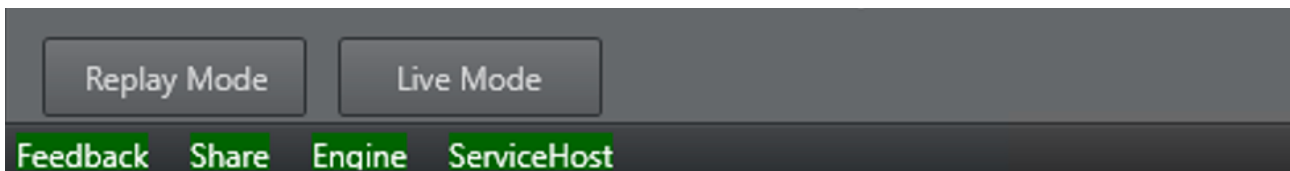

The **Replay** button sets the selected clip channel as FOREGROUND or BACKGROUND depending on which source was selected in the connect dialog.

The **Live** button does the same with the live input.

## Record Group

The Record tab is used to start or stop the recording of a new clip. If not recording, a clipname can be entered in the filename field. The filename is then extended by the channel recorder plug-ins and used for the new clip. Pressing on the **REC** button starts recording.

This is indicated by red blinking of the record button. Pressing **REC** again stops recording.

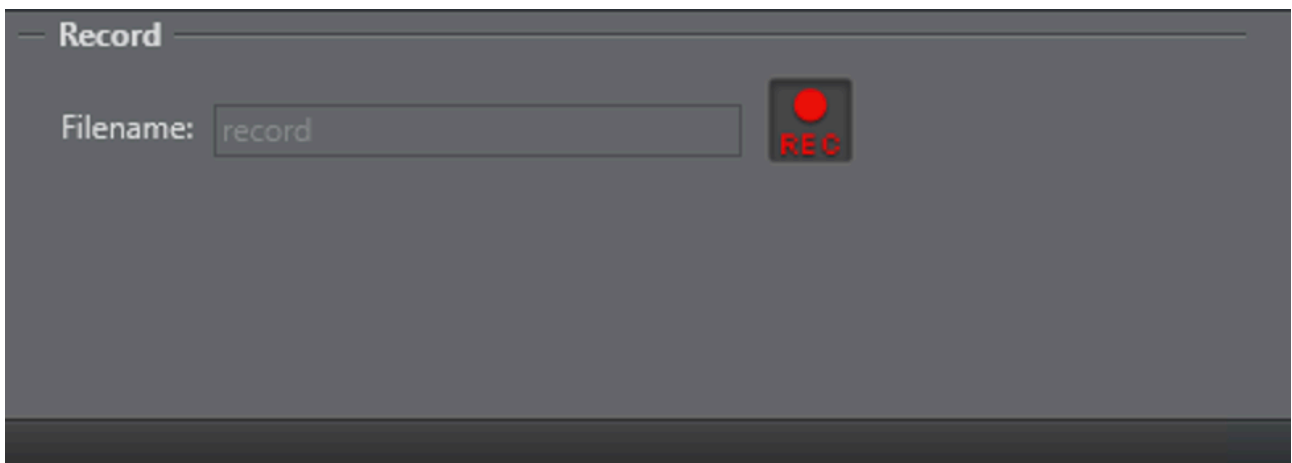
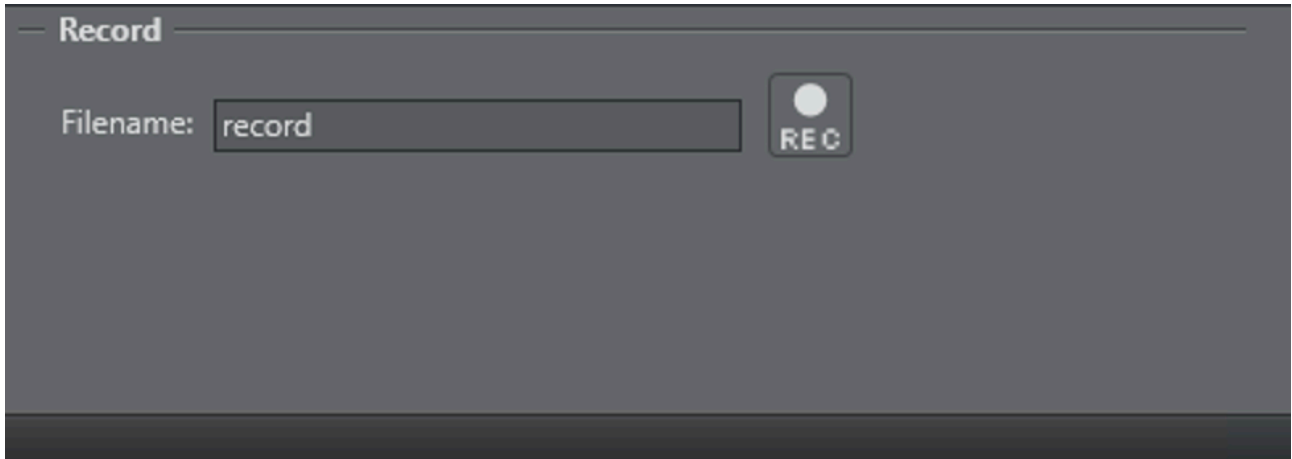

---

## 7.8 Post Data Inspector

The post data inspector is a tool which can load recorded data, either from parameters or camera services, and display this data in a window.

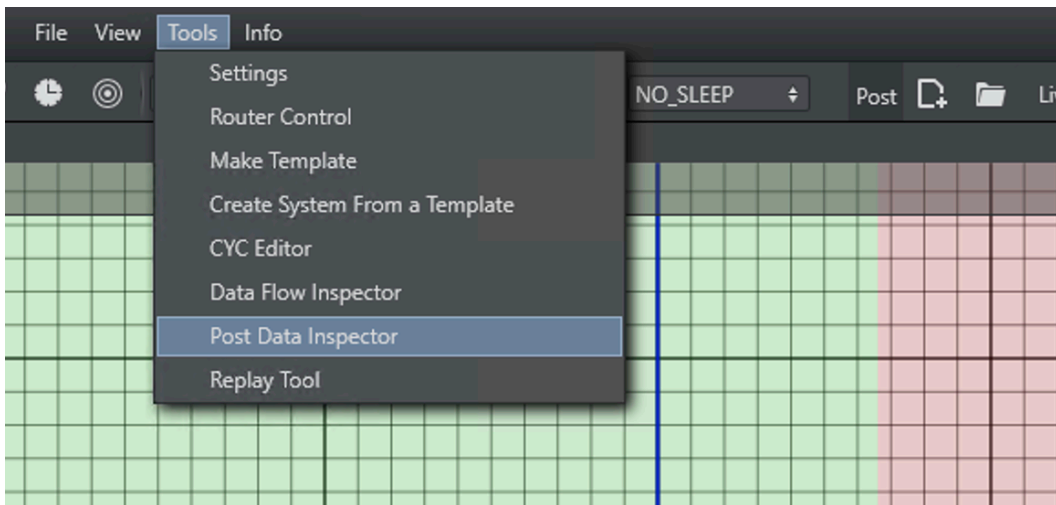

After the window opens, a recorded file can be opened by selecting **File > Load**. A File dialog box opens and a post record session can be selected. If the recording is over several hours, loading can take quite some time. A progress bar in the status line shows the position of reading. After the file has been loaded, the Menus and Camera Channels are filled with the available parameters.

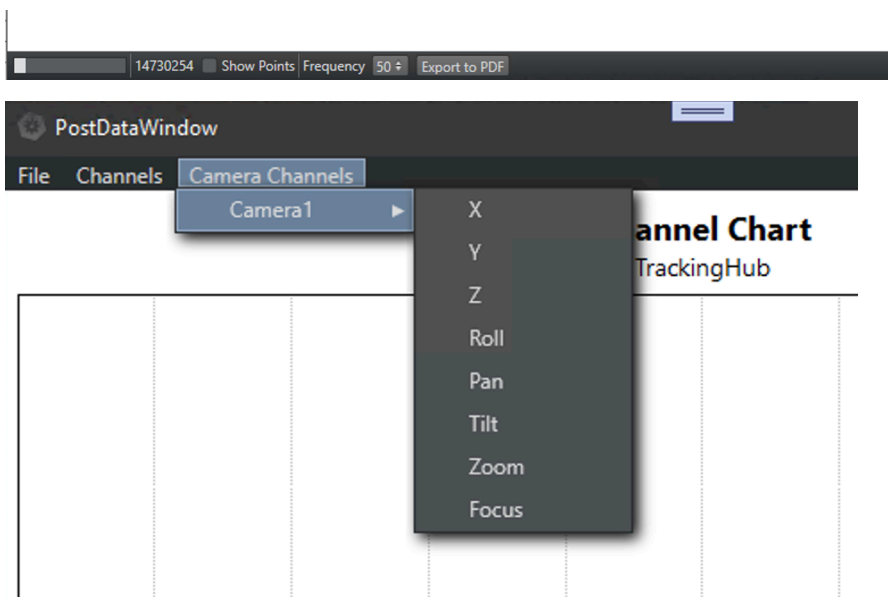

It is possible to multiple select parameters in the menus; however, the units of the parameters can be different (for example, it is not possible to compare distances (cm) with Euler angles).

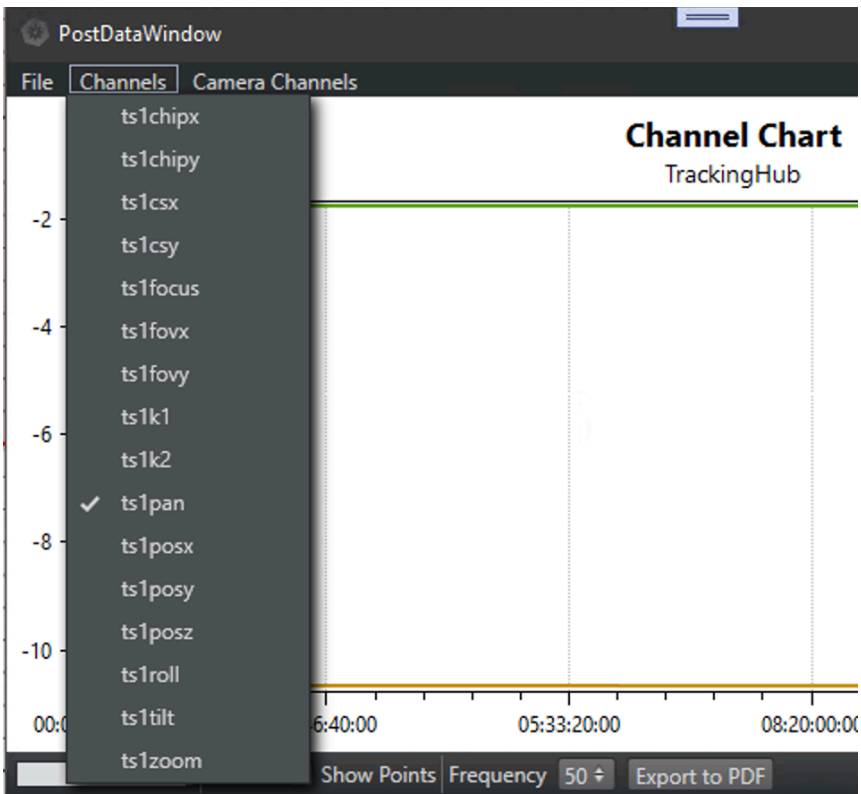

This tool can also be used to make long term recordings of the incoming tracking data. If there is no timecode present or no timecode reader card built into the machine, the Tracking Hub provides SimPost and SimLive timecode.

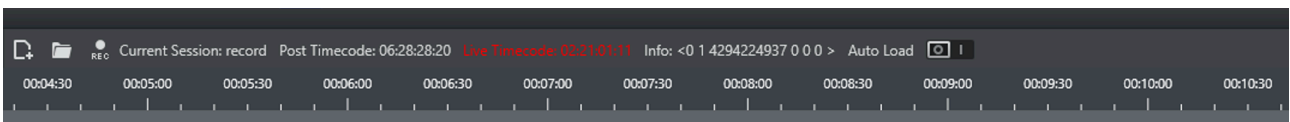

This simulated timecode start at startup time with a value of Zero. So if you need to know the time, the error happened, not the time of the Tracking Hub startup time. Select the tracking system you want to observe and activate the record settings for the incoming parameters.



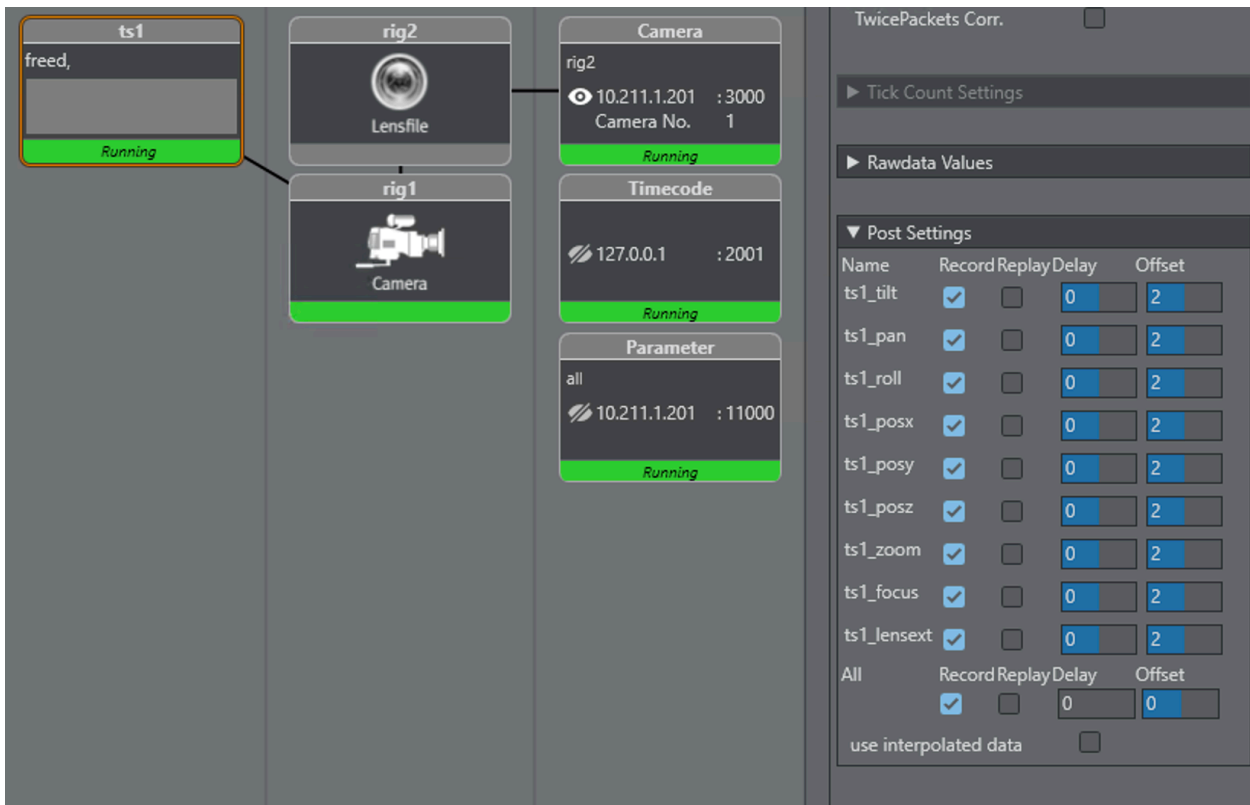

The record time is limited to 24:00 hours, but the recommended recording time should not exceed 12 hours. Otherwise, the PostDataWindow slows down.

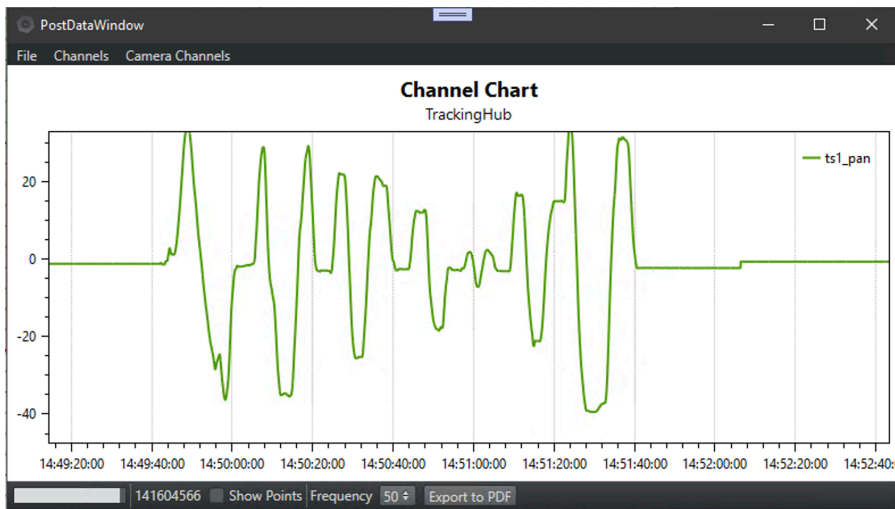

## 7.8.1 Controlling the Data-plot

Action	Shortcut
Pan	Right mouse button, <b>ALT + Left mouse button</b> , <b>UP/DOWN/LEFT/RIGHT ARROW</b> keys, <b>CTRL + ARROW</b> keys for fine pan
Zoom	Mouse wheel, <b>CTRL + Mouse wheel</b> for fine zoom
Zoom in	Mouse extra button 1, <b>+ (Plus)</b> , <b>PAGE UP</b> , <b>CTRL + + (Plus)/PAGE UP</b> for fine zoom in
Zoom out	Mouse extra button 2, <b>- (Minus)</b> , <b>PAGE DOWN</b> , <b>CTRL + - (Minus)/PAGE DOWN</b> for fine zoom out
Zoom by rectangle	<b>CTRL + Right mouse button</b> , Middle mouse button, <b>CTRL + ALT + Left mouse button</b>
Reset	<b>CTRL + Right mouse button double-click</b> , Middle mouse button double-click, <b>CTRL + ALT + Left mouse button double-click</b>
Reset axes	<b>A, HOME</b>
Copy bitmap	<b>CTRL + C</b>
Tracker	Left mouse button, <b>SHIFT + Left mouse button</b> for points only tracker, <b>CTRL + Left mouse button</b> for free tracker (show mouse coordinates basically),

## 7.9 NDI Service

### 7.9.1 Features

Tracking Hub can now receive standard tracking data via UDP or serial connection and embed it into an NDI Stream.

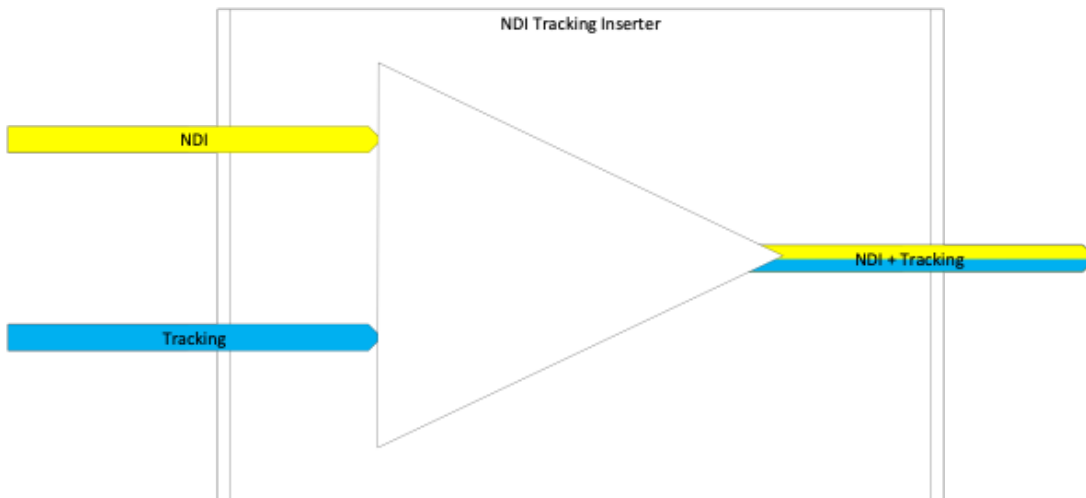

The NDI Service is free running and tries to synchronize the incoming packages from the camera to the incoming video frames from the NDI stream. It is quite important, that the NDI camera is connected to a separate network without any router between the Tracking Hub and the PTZ Camera. It is also mandatory that the Tracking Hub is the only connected instance to the camera.

## 7.9.2 Engine Configuration

In Viz Engine, set tracking data input to SMURF/NDI. Open the configuration file and set the `use_trackinghub` flag to `3`.

```
## 0 = use vizio, 1 = use trackinghub, 3 = use SMURF/NDI
use_trackinghub = 3
```

## 7.9.3 Camera Configuration

There are also some important settings which need to be done in the Camera Setup. As an example, we configured the Panasonic AW100 PTZ camera.

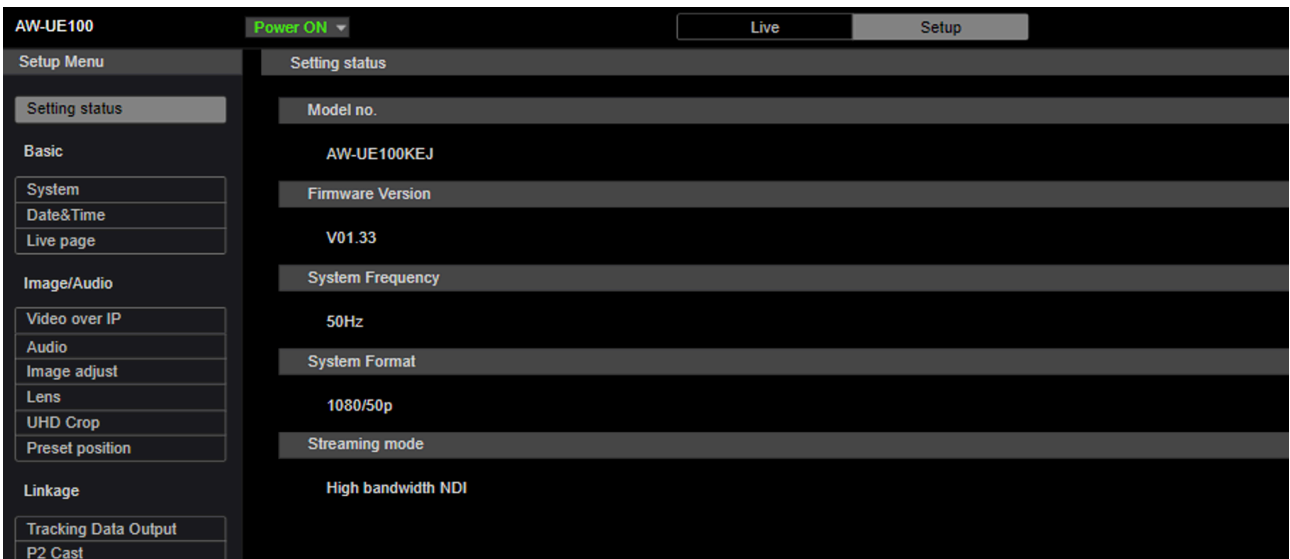

At the time of writing, this is the only camera tested and certified with NDI tracking data. The minimum recommended firmware version is V01.33.

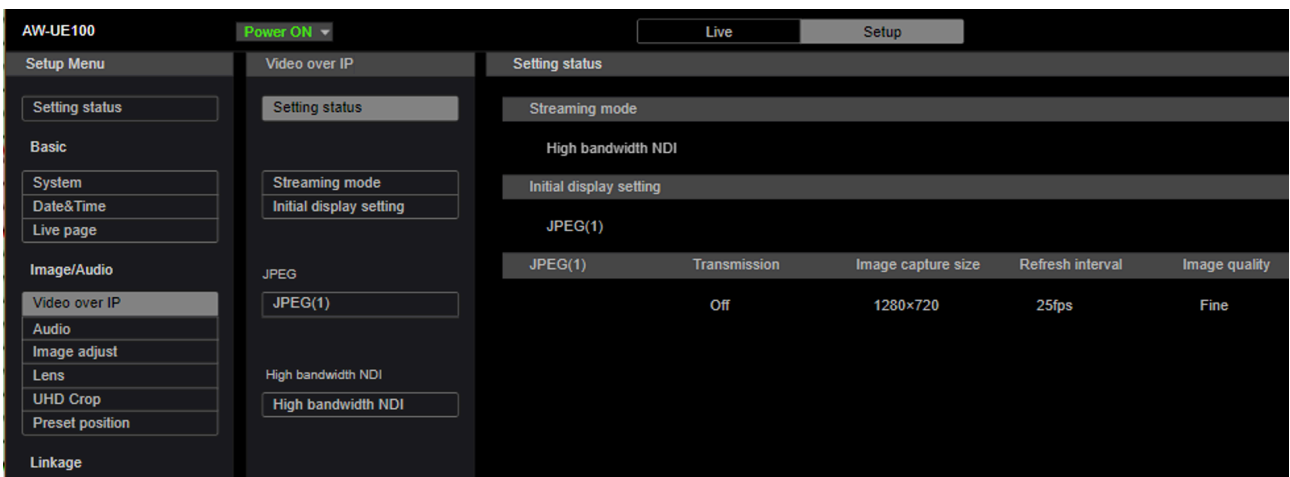

The streaming mode must be set to **High Bandwidth**. It is recommended to switch of JPEG streaming to the web GUI.

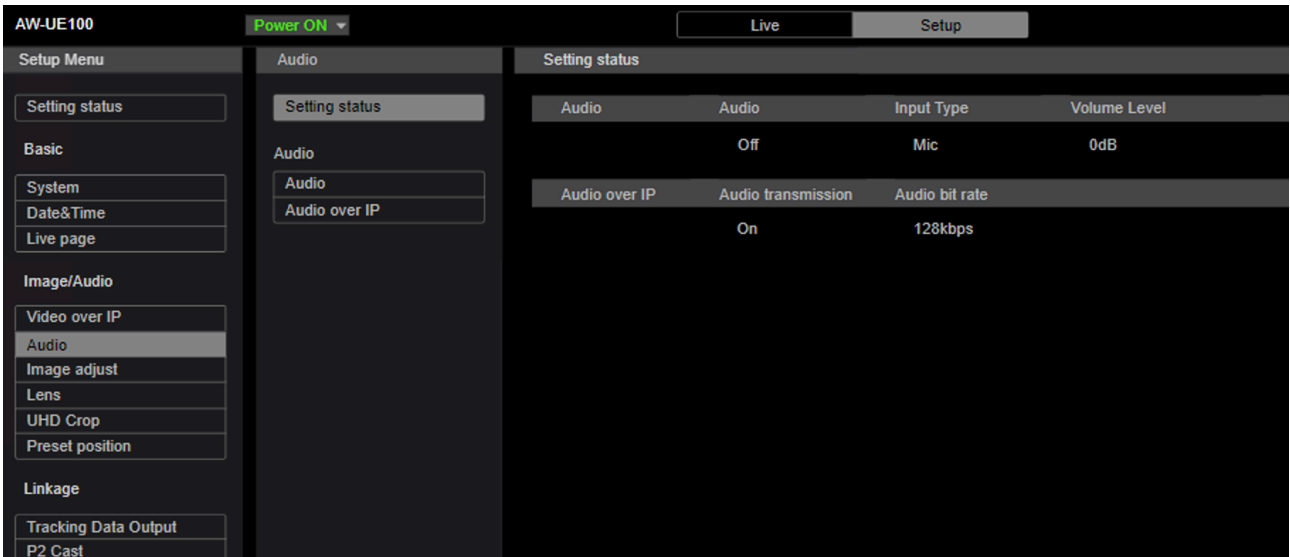

Audio is not supported in Tracking Hub. The reason is that NDI sender like the Panasonic AW100 attempts to synchronize video and audio by repeating or skip frames when audio gets unsynchronized. This leads to delay changes in the tracking data. When a frame is missed, the virtual objects lag behind the real video, and when a field is repeated the virtual objects are in front of the video. It is best to deactivate audio in the camera settings.

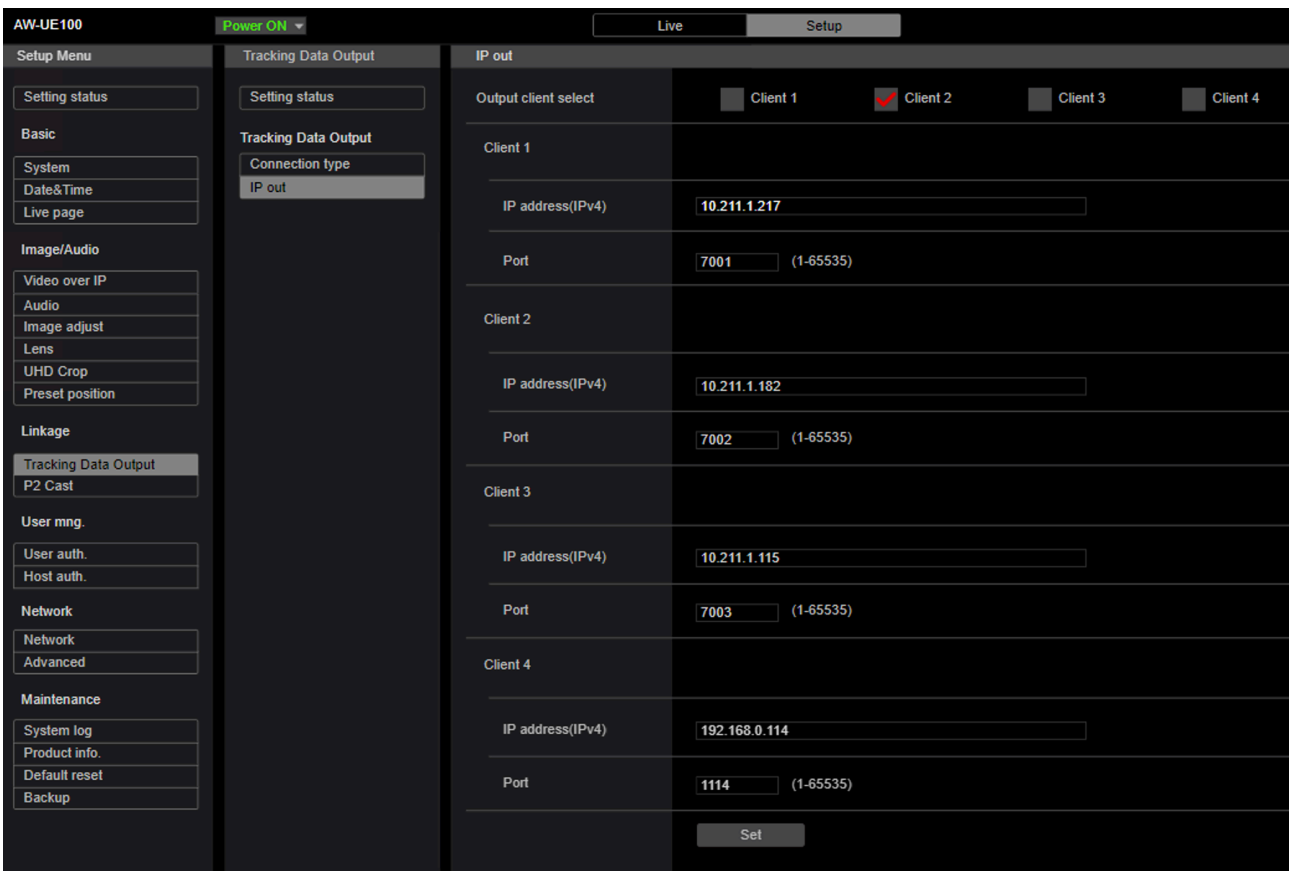

There is also need to activate tracking data output of the camera. Activate one client and enter the IP address of the Tracking Hub. The camera then sends the UDP packets to the tracking driver of the Tracking Hub.

### 7.9.4 Studio Manager Configuration

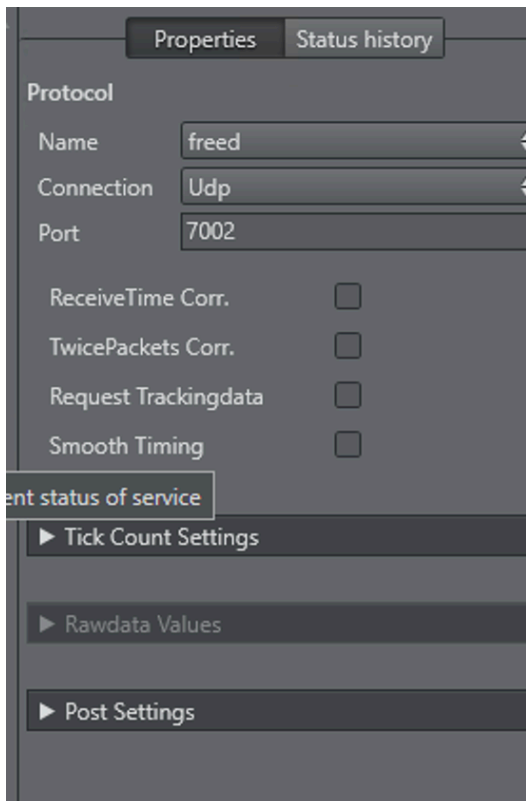

Add a new Tracking Driver and select *freed* as protocol. Enter the port number, which was selected in the setup section of the cameras user interface. In this example, it is `7002`. Then right click on the Tracking Driver and select connect. The tracker changes to green if all values were set correctly.

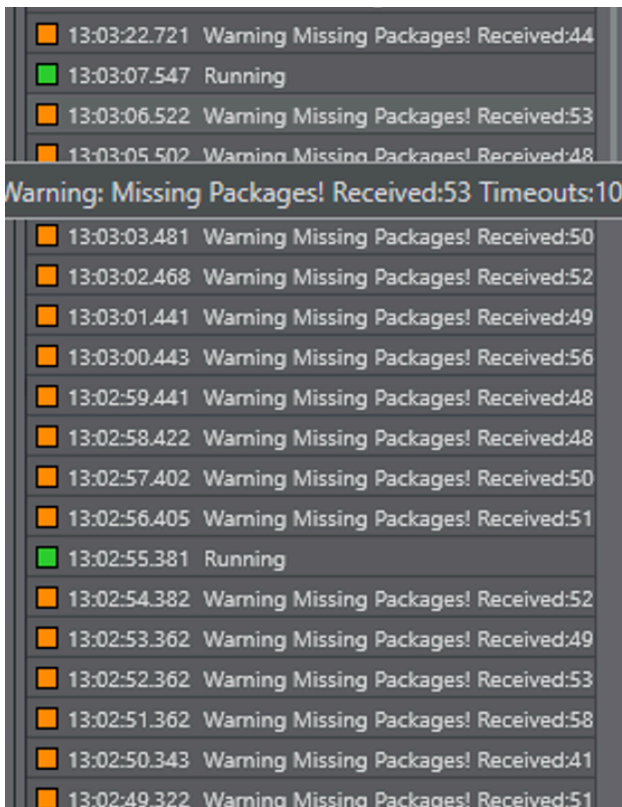

In case the tracker color goes from green to orange and the incoming tracking data is irregular or erratic, the camera needs a reboot. Power off the camera and turn it on again. If the camera data is not coming in correctly after this procedure, check the frame rate and video settings of the Tracking Hub and the camera. The next step is to set up the rig and lens file (please refer to the [Configure Topology](#) section). When the topology is set, a NDI service can be added.

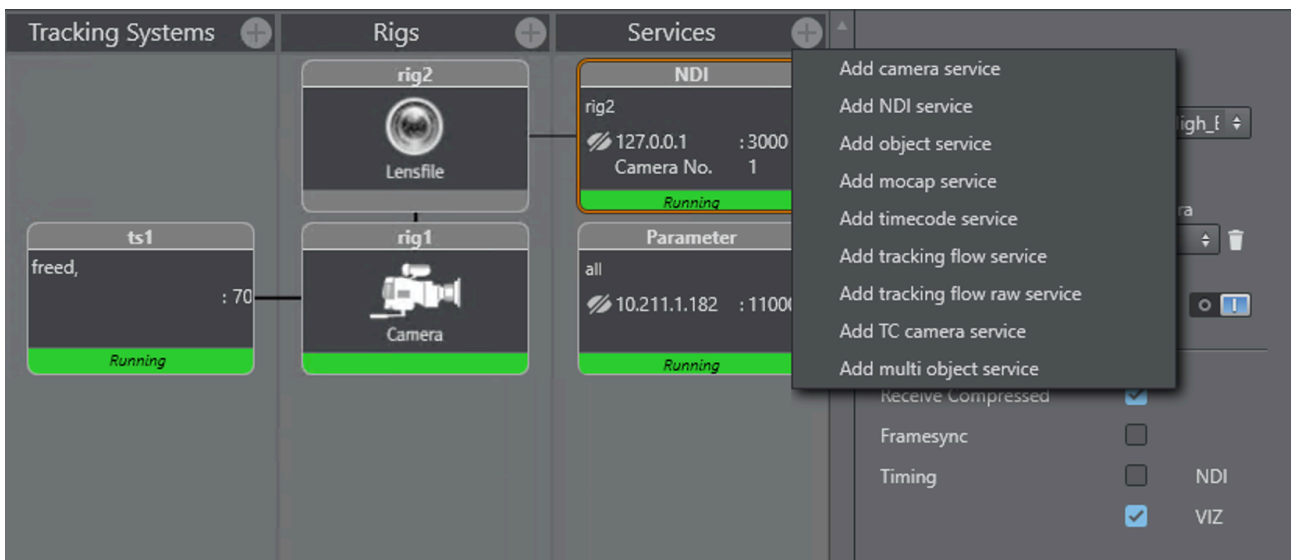

Click on the + Button in the service section of the Studio Manager and **Add NDI service**. The service properties a dropdown shows all available NDI streams. Select the stream of the NDI camera, then add a rig and select the camera number. When using more than one camera, every service should

use a different camera number. When in Viz the video should be switched from one camera to the other, the correct camera number must be sent to Viz Engine.

Like all other Services the NDI Service can be switched On and Off. The other options of the Service are:

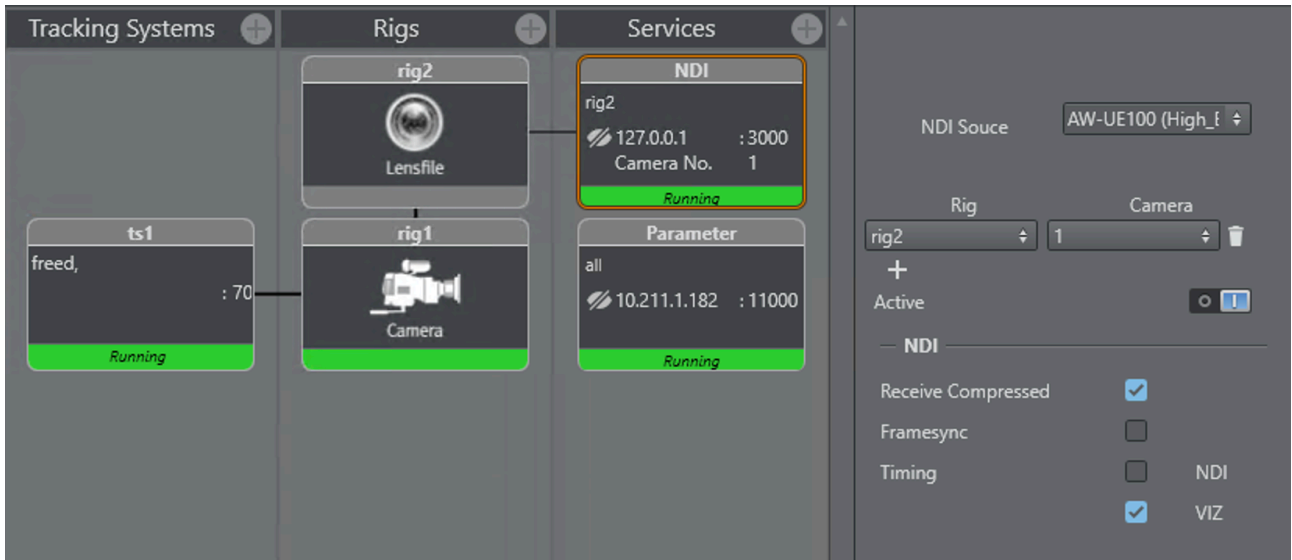

- **Receive Compressed:** Tracking Hub does not try to decode the video frames. It only extracts the Video metadata and adds the tracking information into it. When deactivated, Tracking Hub needs much more CPU resources. This option is on by default.

### 7.9.5 Viz Arc Camera Switching

The following command sequence from VIZ Arc shows the correct commands to switch between camera 1 / LIVE1 and camera 2 / LIVE2. First, create two command buttons in Viz Arc and add the following commands to them:

```

RENDERER SET_CAMERA 1;
MAIN_SCENE*BACKGROUND*IMAGE*IMAGE SET "BUILT_IN*IMAGE*LIVE1";

RENDERER SET_CAMERA 2;
MAIN_SCENE*BACKGROUND*IMAGE*IMAGE SET "BUILT_IN*IMAGE*LIVE2";

```



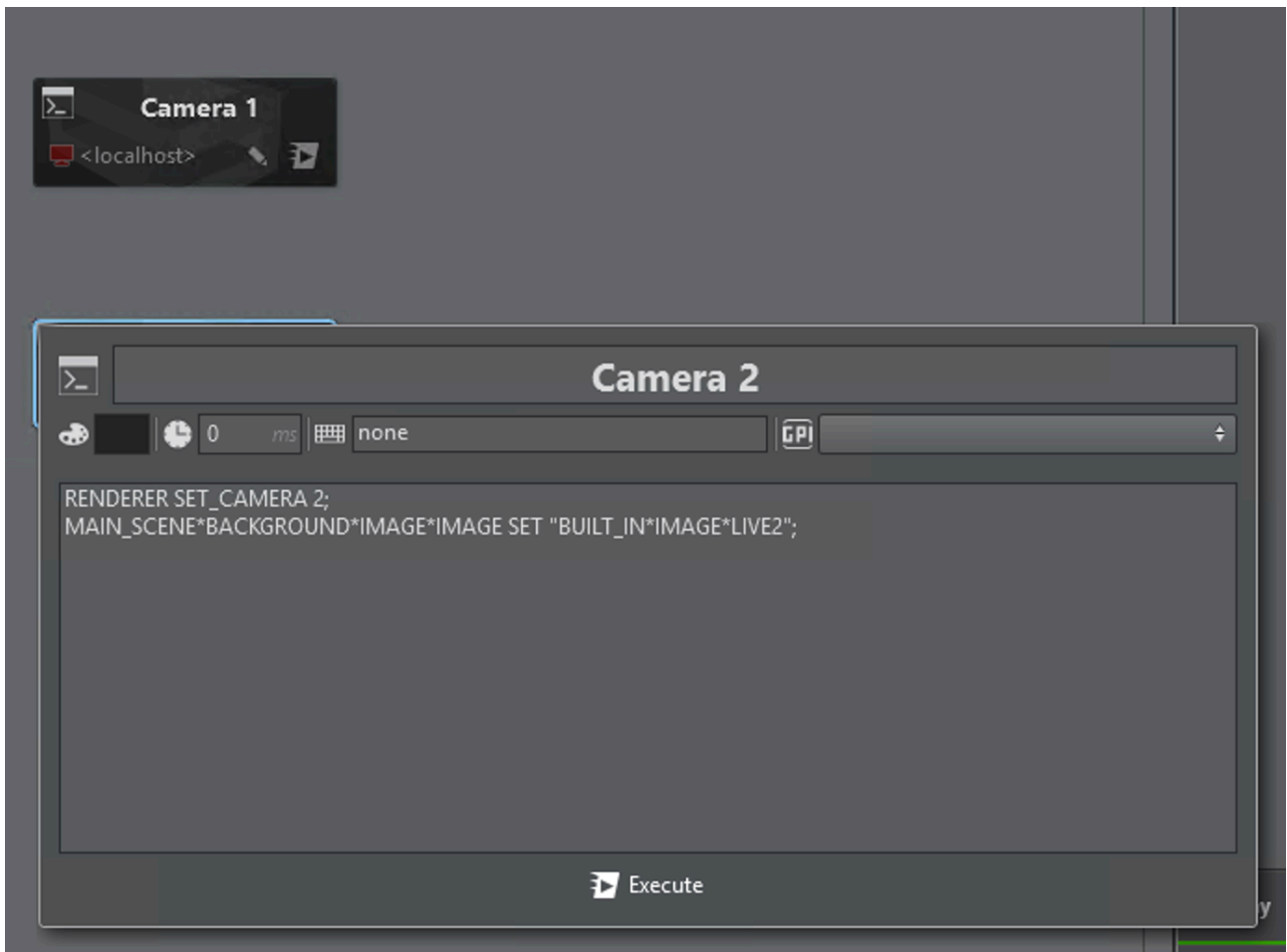

## 7.10 Embedded NDI Tracking Data

### 7.10.1 Introduction

When combining UDP and NDI data, the result depends on how the incoming NDI stream and UDP packages can be combined. The use of audio especially causes frame repeats and frame losses. In this case, a delay change can happen. The only way to overcome this problem is to embed tracking data into the video frames metadata. Tracking Hub is then able to recombine the video frame and data package.



The example configuration above shows a typical NDI setup. The following section goes step by step how this can be set up.

### 7.10.2 Setting up the Studio

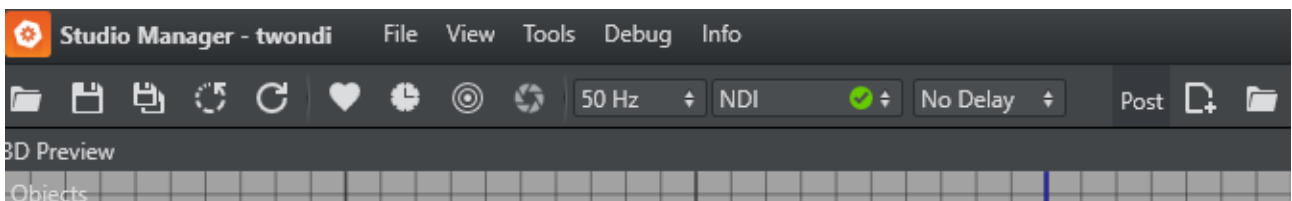

For NDI, the sync source of Tracking Hub can be set to *Free Run*. A new sync mode was introduced which is called *NDI* and which has the same functionality as *Free Run*. It is always shown with the green indicator. Every tracker and NDI service are organized into threads which synchronize to the incoming NDI stream. If there is a Plura card installed and Tracking Hub is set to *AV Card*, the NDI trackers and services are synchronized to the incoming NDI stream.

### 7.10.3 Setting up the Tracker

**Caution:** Viz Tracking Hub 1.7.0 should not have more than one active NDI tracker due to increased performance load on the system. Adding multiple NDI trackers can lead to insufficient GPU resources and an unstable tracking result. GPU recommendation for NDI embedded tracking are NVIDIA RTX 4000 cards or newer.

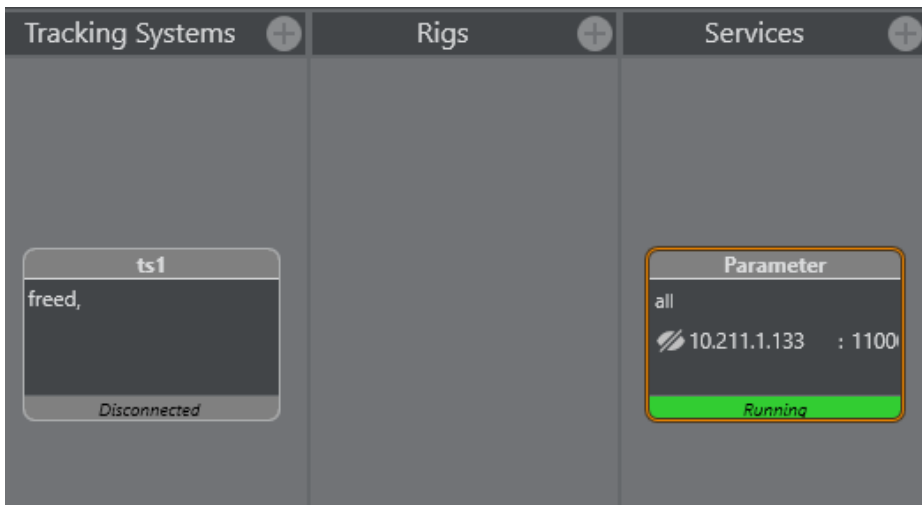

After adding a new tracking driver to the "Tracking Systems" panel a click on the tracker opens the property view.

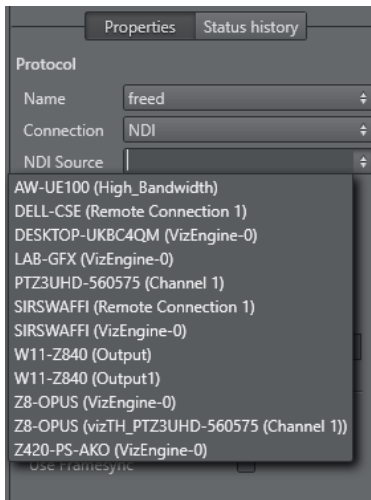

When **NDI** is selected in **Connection**, a combo box appears where the NDI source can be selected.

**Protocol**

Name: freed

Connection: NDI

NDI Source: PTZ3UHD-560575 (Channel 1)

ReceiveTime Corr.

TwicePackets Corr.

Request Trackingdata

Smooth Timing

TO Multiplier: 1,5

---

**NDI**

Receive Compressed

Use Framesync

► Tick Count Settings      Error Percentage

► Rawdata Values

► Post Settings

There are two NDI options available:

- **Receive Compressed:** The incoming NDI stream is not decoded by Tracking Hub. Only the metadata is read and analyzed, minimizing GPU and CPU usage. This option is enabled by default.
- **Use Framesync:** The NDI Library tries to harmonize the timing of incoming and outgoing frames when activated. This is not needed for the NDI tracker and Tracking Hub to send out a new frame, when one frame is coming in without waiting. It is not needed for the PTZ3 camera model but could be needed for future camera models. This option is not recommended. By default it is switched off.

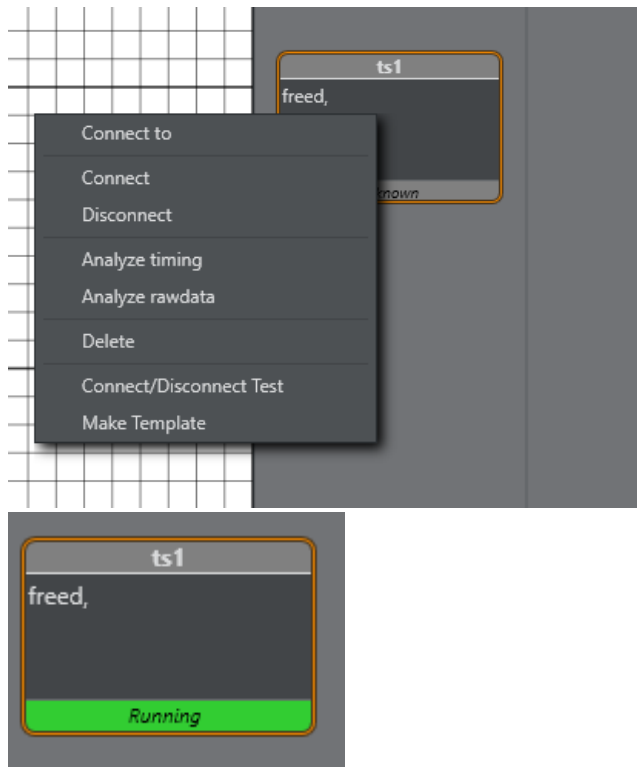

After connecting the tracking system the driver should become green and the status is running. Green means that Tracking Hub was able to find the tracking data in the metadata of the video and was able to decode it.

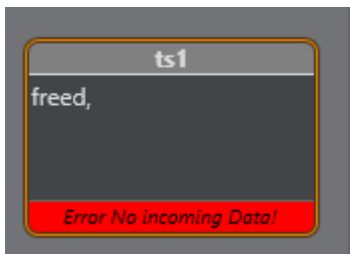

If no data is present in the NDI stream, Tracking Hub shows *Error, No incoming Data!*.

#### 7.10.4 Setup Rig Topology

For setting up a rig topology in general, see [Configure Topology](#). Make sure that the rig has the *Use LeastSquare* option activated when using NDI with embedded tracking data.

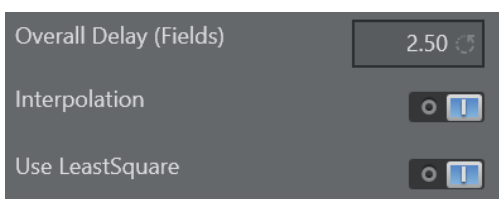

### 7.10.5 Setup NDI Service

After connecting the parameters to the Rig structure the setup looks like this:

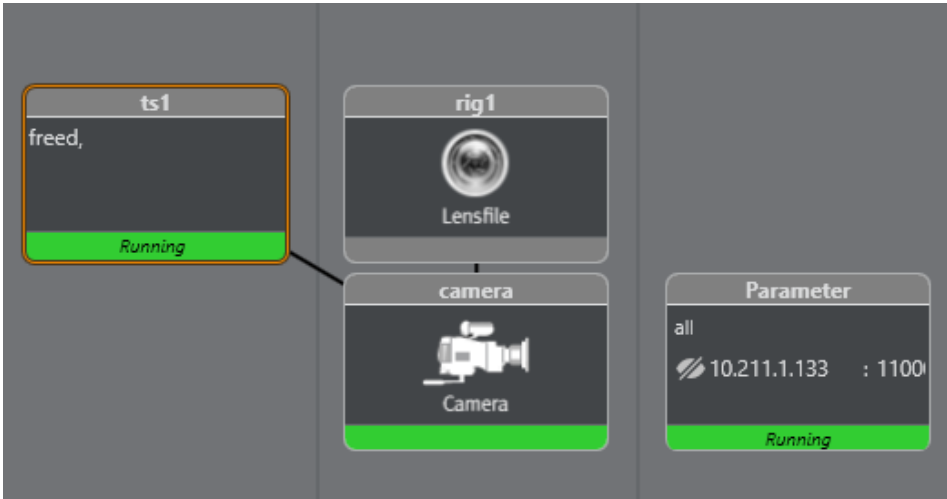

After adding a NDI service and clicking on it the following properties panel appears:

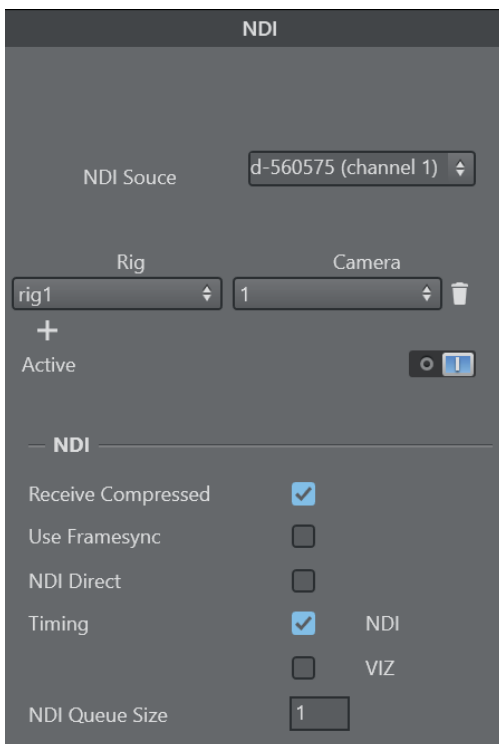

Add a rig and camera number to the service. Please see: [Configure Topology](#)

**⚠ IMPORTANT!** The chosen NDI source in the NDI service has to match the source in the tracking system. If a different NDI source is connected, the tracking system automatically disconnects.

As soon as the rig is connected, the NDI source of the tracker and the service are connected. This is also true for the NDI options. Please see above in [Setting up the Tracker](#) for the meaning of the options.

The NDI Queue size can be used to change the delay of the NDI signal. By default the size is set to 1. This does not have any influence on the tracking delay. It delays the overall delay including the tracking data. The delay of the tracking data must be set in rigs overall delay and in the parameter delay settings.

 **Note:** The cyc data is sent to Viz Engine only, when at least one camera service exists. In case of NDI, at least one camera service must exist for every Viz Engine.

---

## 8 Troubleshooting And Best Practices

This section lists some common pitfalls and how to solve them, as well as providing guidance on optimizing your virtual studio workflow.

- [General](#)
- [Tracking](#)
- [Lenses](#)
- [Delay](#)
- [NDI](#)
- [Chroma Keying](#)

---

### 8.1 General

- Depending on your tracking system, a zero point is required. This marks a special location in your studio defining the start- or reference point. The design of your set (Viz Scene) and the calibration relies on this location; therefore, clearly mark it.
- Make sure you use correct units during your set design. This makes it much more easier to match your set later on.
- The Studio Manager is mainly used to configure and setup your virtual set. During production this application is not needed and should be closed. Only Tracking Hub needs to be running.

#### 8.1.1 Syncing

- **As a general rule:** Every single component in your setup needs to be synced correctly. This includes any router, camera, Viz Engine, keyer etc.

---

### 8.2 Tracking

#### 8.2.1 Tracking Networks

- It is recommended to use a dedicated network to transport your tracking data.
- Make sure no firewalls, load balancers or similar can have any negative impact on the transport of your tracking data.

---

### 8.3 Lenses

- Every Lensfile is unique. It is highly recommended to calibrate each lens on the mounted final camera rig. Even if you have an existing lens file available, it might not be sufficient to use this one for another lens of the same type.



---

## 8.4 Delay

- To get a precise match between real live video and the Engine rendering, the tracking data has to be delayed properly to react within the same field. This can be done for each parameter individually or, in most cases, is handled with the *Overall Delay* on the camera rig node.
  - Adjusting the delay can be easily achieved by making quick changes in camera movement to see if the tracked graphic starts before the video signal or if it stops after it. Best practice here is to start with a high delay and decrease it slowly until both layers match perfectly while panning the camera left and right. Once this fits, check the other parameters. In some cases zoom and focus need a different delay which will be added / subtracted from the overall delay by adjusting the specific delay of these parameters separately.
- 

## 8.5 NDI

### 8.5.1 Requirements and Limitations

- Only one NDI input source is supported.
- The network bandwidth needs to fit your needs. It is highly recommended to use a dedicated network for the NDI transport.
- Only tested and certified PTZ cameras are supported. See [Supported NDI Cameras](#).
- Make sure no other applications connect to your NDI source. This also includes NDI Studio Monitor, for example.

To use NDI in your virtual studio, make sure the following conditions are fulfilled:

- In the Engine Settings, all video boards must be deactivated and *NDI* must be selected.

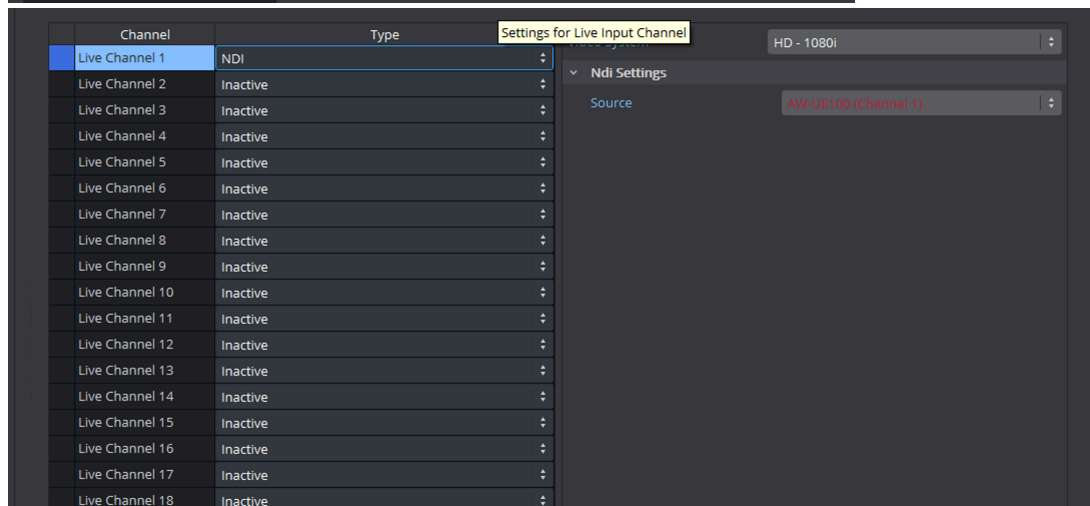
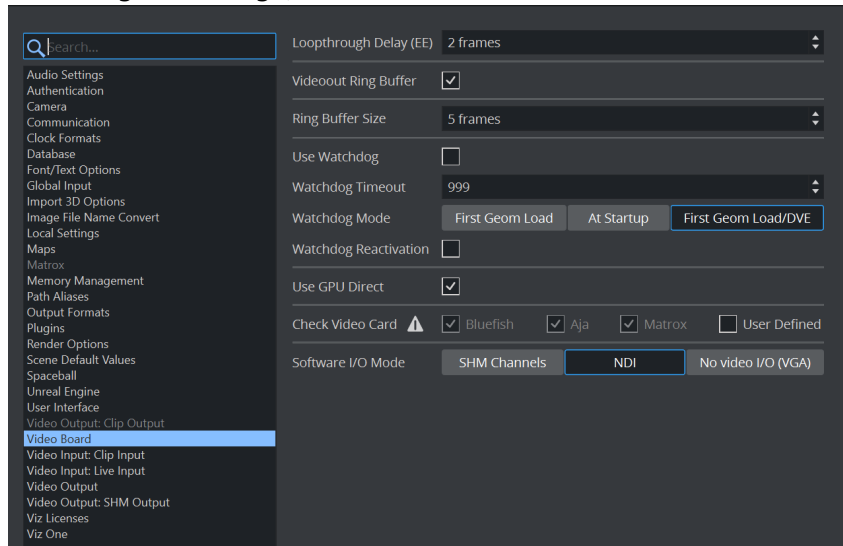

- As the Sync source settings are not available after switching to NDI, check the following setting in the config file:  
Section Genlock: The Genlock must be set to `2`.

## 8.6 Chroma Keying

Make sure your lighting conditions are the best ones you can achieve. Optimal chroma keying results depend strongly on the good quality of both cyc and homogeneous light.

## 9 Appendices

This section contains the following topics:

- [Words and Terminology](#)
- [Supported Protocols](#)
- [Supported NDI Cameras](#)
- [Description of the XML protocol description file format](#)
- [Motion Analysis Integration](#)
- [Ports Used by Tracking Hub and Studio Manager](#)

### 9.1 Words And Terminology

Some commonly used words and terminology are described in this section:

Term	Definition
Virtual Studio	The real-time combination of people or other real objects and computer generated environments and objects in a seamless manner.
Viz Virtual Studio	A solution to create and manage virtual studios. Consists of the applications Tracking Hub and Studio Manager and is used in combination with Viz Engine and control applications such as Viz Trio, Viz Mosart or Viz Opus.
Tracking Hub	A control process (service) to receive, control and forward sensor input such as camera movements. A console program.
Studio Manager	A GUI program to setup and control Tracking Hub and the Virtual Studio environment.
Rig	Refers to the physical objects such as camera rigs, pedestals and more.
Lattice	In a virtual studio environment, lattice is often used synonymous with RIG.
Cyc	Comes from the word Cyclorama. It was formerly used in theaters to encircle or partially enclose the stage from a background. In a Virtual Studio, the Cyc defines the green (or blue) area, where virtual objects can appear behind real objects.
CoCyc	The CoCyc is the mask (geometry), which is used to hide real objects from the camera. The CoCyc is indirectly defined by the Cyc. Also known as the <i>trash matte</i> .
HUD	Heads Up Display.

Term	Definition
Chroma Keyer	Chroma key compositing, or chroma keying, is a special effects / post-production technique for compositing (layering) two images or video streams together based on color hues (chroma range). The <a href="#">Viz Engine</a> can generate key and fill and can, if required, also be used with an external Chroma Keyer.
Synchronization	Using a reference signal to synchronize a video signal. Typical Blackburst, Tri-Level or using the Viz Engine digital input signal as sync.

## 9.2 Supported Protocols

Currently, Tracking Hub has native support for the following protocols:

- FreeD (see [Description of the XML protocol description file format](#))
- Shotoku
- RTHed
- NCam
- Xpecto
- XML Tracking: A special feature, a self-definable protocol for special solutions
- Motion Analysis (it is possible to work with two MA instances)
- mo-sys (with lens information)
- Trackmen
- Trackmen Mocap
- Vicon
- Libero
- Spidercam
- spidercamfd
- Spidercam-frameb
- Flair
- Thoma
- Stype A5
- Stype HF
- Camreginfo
- Technodolly
- Skycam
- Gsgeopoint
- Kuper
- FreeDa0
- Telemetrics
- hd-Skycam
- kromanov
- Arraiy (only with VIZRT lensfile)
- Sky X Cam
- Cable Cam

- Eagle Eye
- GeoPro

**Important:** Tracking Hub is able to parse these protocols and send the translated data to Viz Engine. Being in this list does not mean the tracking system is certified!

## 9.3 Supported NDI Cameras

The following cameras have been tested and certified by Vizrt:

- Panasonic AW-UE100KE
- Newtek PTZ3
- Newtek PTZ3 UHD

For augmented (no chroma key) using external FreeD tracking data:

- Panasonic AS-UE150W/K

For augmented or Virtual Studio using embedded FreeD tracking data:

- Newtek PTZ 3 UHD

## 9.4 Description Of The XML Protocol Description File Format

Like most tracking formats the XML description can be used to send an arbitrary number of axes to Tracking Hub. It is possible to define a checksum and the default connection parameters, which is then set in Studio Manager, when the protocol is selected from the User.

Setting the connection parameters is optional. The definition starts with:

```
<?xml version="1.0" encoding="utf-8"?>
```

### 9.4.1 Start Element “vizth\_xml\_tracking”

A tracking definition must define this element with the attribute “title”:

```
<vizth_xml_tracking title="name">
```

In Studio Manager, the title attribute is used in the list of tracking systems. It should be unique.

## 9.4.2 Checksum Element

The checksum element defines the length of the packet and the method of the checksum calculation. The attribute “pkglen” is mandatory and must match the size of the complete package including header and checksum. It is given in bytes.

The attribute “checksum” is optional. If not given no checksum is calculated. If it is bigger than zero the following calculations are done:

- 1: 0x40 - sum of all bytes (same as Freed protocol)

```
Sum = 0x40u - Sum;
return ((Sum & 0xFF) == value of last byte of the package excluding checksum byte
```

- 2: sum of all bytes

```
Sum= sum of all bytes
return ((Sum & 0xFF) == value of last byte of the package excluding checksum byte
```

- 3: inverted sum of all bytes

```
Sum = (WORD)(~Sum);
return ((Sum & 0xFF) == value of last byte of the package excluding checksum byte
```

The checksum byte is always the last byte in the tracking package.

## 9.4.3 Extraction

The element “extraction” is mandatory and defines with the attribute “count” the amount of axes in the tracking package. Optional you can define separator, if you keep it empty, it is not used. If you define this separator, the tracking package departs first before the values are calculated. It also contains the “axis” elements which define the axis values, the type, the position in the package, the length, the byte order and the calculation method.

## 9.4.4 Axis Element

The “axis” elements are part of the “extraction” element. The amount of axes elements must match the attribute “count”.

## Axis Attributes

- **name:** Defines the name of the axis and this also defines how the axis is displayed in Studio Manager. Every axis name must be unique for the actual extraction element.
- **start:** Defines the byte position in the package.
- **len:** Defines the length of the axis in bytes.
- **order:** Defines the byte order of the numeric value. This attribute can have the following values.
  - “bigendian”
  - “littleendian”
  - “ascii” If ascii is given the bytes are interpreted as string.
- **value:** Defines the numeric encoding of the axis. Valid values are:
  - “INT32”
  - “UINT32”
  - “FLOAT”
- **calc:** Defines the mathematical operation which is needed to calculate the axis value in Tracking Hub units. For angle values, Tracking Hub uses Euler angles. For distance or position centimeters are used. The value of this attribute is a string which starts with a mathematical operator, a white space and a number. Allowed operators are:
  - “+” Addition
  - “-” Subtraction
  - “/” Division
  - “\*” Multiplication
  - Any other character is ignored.
- Tickcount values and Offsets are handled outside this description, and can set on the standard places like for other protocols.

```
<?xml version="1.0" encoding="utf-8"?>
<vizth_xml_tracking title="xml_freed">
  <checksum pkglen="29" calculation="1" />
  <extraction separator="">
    <axis name="rotx" start="5" len="3" order="bigendian" value="INT32" calc="/ ">
  </axis>
    <axis name="roty" start="2" len="3" order="bigendian" value="INT32" calc="/ ">
  </axis>
    <axis name="rotz" start="8" len="3" order="bigendian" value="INT32" calc="/ ">
  </axis>
    <axis name="posx" start="11" len="3" order="bigendian" value="INT32" calc="/"
"></axis>
    <axis name="posy" start="14" len="3" order="bigendian" value="INT32" calc="/"
"></axis>
    <axis name="posz" start="17" len="3" order="bigendian" value="INT32" calc="/"
"></axis>
    <axis name="zoom" start="20" len="3" order="bigendian" value="INT32" calc="-"
"></axis>
    <axis name="focus" start="23" len="3" order="bigendian" value="INT32" calc="-"
"></axis>
```

```

    <axis name="iris" calc="!"></axis>
  </extraction>
</vizth_xml_tracking>

```

```

<?xml version="1.0" encoding="utf-8"?>
<vizth_xml_tracking title="kuper">
<checksum pkglen="0" calculation="0" />
<extraction separator="," >
<axis name="tilt" field="1" order="ascii" value="FLOAT" calc="/" />
<axis name="pan" field="2" order="ascii" value="FLOAT" calc="/" />
<axis name="zoom" field="3" order="ascii" value="UINT32" calc="/" />
<axis name="focus" field="4" order="ascii" value="UINT32" calc="/" />
</extraction>
</vizth_xml_tracking>

```

## 9.5 Motion Analysis Integration

Motion Analysis (MA) is handled like any other tracking system in Viz Virtual Studio. There is no hard limit to the number of objects which can be tracked by Tracking Hub. This section provides some information specific for the MA systems.

### 9.5.1 The CORTEX System

The setup and calibration of the MA Raptor camera system is done by trained Motion Analysis Corporation Engineers. The software to control the cameras and the tracking is called Cortex. Initially, Cortex was developed for Motion Capturing and not for camera tracking (camera tracking functionality was added later). Therefore, most of the camera settings are not immediately obvious. This is especially true when it comes to camera offset fine adjustment and CCD calibration.

### 9.5.2 CCD Calibration

Cortex calibrates the relative position of the CCD to the target base using an image based method. The camera observes a target, which is moved in several positions. From this data, the software is able to calculate the position and the field of view of the camera. Like all image based methods, this calculation is not 100% accurate and there is always need to fine-tune the pan, tilt and roll angles. The fine-tuning of position and angles is always done in the Cortex system and never in the offset page of the tracking driver.

### 9.5.3 Sync and FPS (Frames per Second)

Every part of a Virtual Studio must be in sync. This is true for Cortex and the Raptor cameras as well. You should check that MA are connected to the same sync as Visual Studio or if the signals times are moving independently.



## 9.5.4 Timing

Depending on the timing family of the sync signal the Cortex system must be set to the following settings:

- **50 Hz format:** Cortex runs at 150 FPS with three frame reduction.
- **59.94 Hz formats:** Cortex runs at 120 FPS with two frame reduction.

These settings guarantee the lowest latency of the cortex system.

## 9.5.5 Network Connection

The Cortex system communicates through a network with Tracking Hub. This communication is time critical. Every delayed package is worthless for the Virtual Set and results in a jitter.

**IMPORTANT!** A separate tracking network between the computer running Tracking Hub and the Cortex machine is mandatory.

The use of a managed switch is allowed, when it is possible to define a separate subnet for the tracking connection. If such a switch is not available, the use of a direct connection or a (basic) unmanaged switch for the connection is recommended.

## 9.5.6 Cortex Precision Limit

All optical tracking systems show a jitter in position and angle. The jitter in the rotation angles is much more visible than position jitter. The Cortex precision limit for angles is below 1/100th of degree. Even though this is quite accurate, the jitter is still visible when zooming completely in on a telephoto lens. It is not recommended to use complete near shots with any optical tracking system. One possibility is to use a mechanical tracking head for those shots.

## Zoom and Focus Encoder

The Motion Analysis system uses a Zoom and Focus encoder to allow Viz to calculate the actual Field of View of the Lens. The choice of the encoder is important for the perfect result.

The following external encoders are recommended when no internal digital encoders on the lens are available:

- MoSys
- Shotoku
- EncodaCam
- Internal digital lens encoders

## 9.5.7 Motion Capturing

Please see [Topology Panel](#).

## 9.6 Ports Used By Tracking Hub And Studio Manager

The following lists the ports used by Tracking Hub and Studio Manager. Please note that this may be different due to the tracking systems in use.

Port Number	Protocol	Used for
<b>Tracking Hub</b>		
4568	UDP	
6000	UDP	
7111	UDP	For example, FreeD protocol
9090 (configurable)	TCP	Lensfile Editor Web Interface
20000	TCP	Command Port
<b>Studio Manager</b>		
7000	UDP	Viz Engine Communication
11000 (configurable)	UDP	Parameter Service Port
<b>Other Components</b>		
22352	TCP, UDP	Codemeter
<b>Other Ranges</b>		
> 50465		used by Tracking Hub
> 50786		used by Studio Manager